



ICSS V

5<sup>th</sup> International Conference on Social Sciences

Proceedings Book

Volume II

Edited by

Prof. Assoc. Dr. Ahmet Ecirli

Prof. Dr. Mixhait Reci

International Conference on Social Sciences

10-11 April 2015, Pristina

Iliria College



9 788890 916397

REVISTIA  
PUBLISHING AND RESEARCH

Proceedings of the International Conference on Social Sciences

10-11 April 2015

Volume II

In cooperation with  
Iliria College, Pristina - Kosovo

ISBN 9788890916397

Every reasonable effort has been made to ensure that the material in this book is true, correct, complete, and appropriate at the time of writing. Nevertheless, the publishers, the editors and the authors do not accept responsibility for any omission or error, or for any injury, damage, loss, or financial consequences arising from the use of the book. The views expressed by contributors do not necessarily reflect those of Revistia.

Typeset by Revistia

Printed in Pristina

Copyright © Revistia. All rights reserved. No part of this book may be reproduced in any form or by any electronic or mechanical means, including information storage and retrieval systems, without written permission from the publisher or author, except in the case of a reviewer, who may quote brief passages embodied in critical articles or in a review.

Address: 11, Portland Road, London, SE25 4UF, United Kingdom

Tel: +44 2080680407

E-Mail: [office@revistia.com](mailto:office@revistia.com)

Web: <https://books.revistia.com>

**TABLE OF CONTENTS**

<b>The Effect of Psycho Education Program for Prevention of Test Anxiety on 8th Grade Students to Reduce Anxiety and Indecisiveness .....</b>	<b>9</b>
Mehmet Kaya .....	9
<b>Unequal Itineraries for Graduates: a Typology of Entrance into Labour Market .....</b>	<b>16</b>
Ana Paula Marques .....	16
<b>Formation of the Volunteering Institute in Russia as an Indicator of the Civil Society Development.....</b>	<b>24</b>
Isaeva Elena Alexandrovna.....	24
Sokolov Alexander Vladimirovich.....	24
<b>Financial Inclusion and Turkey .....</b>	<b>32</b>
Nuray Terzi .....	32
<b>The Image and Perceived Quality of Universities as Important Dimensions for Building University Brand Equity -Case Study Involving Albanian Students .....</b>	<b>42</b>
Assoc. Prof. Dr Vjollca HYSI (PANAJOTI) .....	42
Dr. Irma Shyle .....	42
<b>Waste Management in Ancient Times and Today from the Perspective of Teachers: Reflections to Diaries.....</b>	<b>52</b>
Dilek Erduran Avcı .....	52
Huriye Deniz Çeliker .....	52
<b>The Importance of Four Skills Reading, Speaking, Writing, Listening in a Lesson Hour .....</b>	<b>58</b>
PhD Cand. Lorena Manaj Sadiku .....	58
<b>Digital Generation - Analysis of the Use of ICT by Young Poles .....</b>	<b>61</b>
Dr Agnieszka Stanimir .....	61
<b>The Analysis of Interpersonal Conflict Resolution Approaches of University Students by Grade Level and Gender .....</b>	<b>71</b>
Abdülkadir Avcı .....	71
Bilge Aydaş .....	71
Özgür Arlı.....	71
<b>Spatial Analysis of Adults Involvement in Education in Poland .....</b>	<b>80</b>
Alicja Grześkowiak.....	80
<b>The SME in a Globalized Economy. Challenges of the Albania's SME in the Optic of Small Business Act .....</b>	<b>90</b>
Eralda Xhafka.....	90
Elidon Avrami .....	90
<b>Problems Associated with the Legal Substance of Real Estate Encumbrances .....</b>	<b>103</b>

Mg. iur. , PhD cand. Inga Kudeikina .....	103
<b>Investigating the Twin Deficits in Albania .....</b>	<b>110</b>
Ermira H. Kalaj, Ph. D. ....	110
Prof. Dr. Mithat Mema .....	110
<b>The Integrated Model of Dwyer and Kim as a Tool to Evaluate and Rank the Determinant Attributes of a Tourist Destination Competitiveness .....</b>	<b>115</b>
Sonila Berdo .....	115
<b>Comparative Study in Central and Eastern Europe Regarding Restitution/Compensation Process .....</b>	<b>119</b>
Ph. D. Cand. Saida Bejtja .....	119
Ph. D. Cand. Dritan Bejtja .....	119
<b>An Integrative Approach in Treating Complete Food Refusal in Children: a Case Study .</b>	<b>134</b>
Khamsiah Ismail, Ph. D .....	134
Siti Rafiah Abd Hamid, Ph. D .....	134
<b>Teaching Contemporary and the Role of the Teacher in the Classroom with the Student Centered.....</b>	<b>148</b>
Dr. Prof. Ass. Fatmir Vadahi .....	148
Mr. sc. Dritan Ceka .....	148
Mr. sc. Anila Jaku .....	148
<b>The Distribution in International Marketing - Correlation between International and Local Channels in Kosovo.....</b>	<b>157</b>
Hidajet Karaxha PhD candidat.....	157
Halit Karaxha PhD candidat .....	157
<b>Usage of EduBlogs Among Malaysian Secondary School Students .....</b>	<b>165</b>
Dr. Arumugam Raman.....	165
Yahya Don .....	165
Yaakob Daud .....	165
<b>Formation of linguistic culture of pupils by working with vocabulary .....</b>	<b>174</b>
Doc. Dr.. Kledi Satka (Shegani) .....	174
Doc. Dr. Albana, Deda (Ndoja) .....	174
<b>The Relationship between Culture and Organizational Commitment among Chinese primary School Teachers.....</b>	<b>178</b>
Arumugam Raman .....	178
Lim Tse Ying.....	178
Rozalina Khalid .....	178
<b>The Role of Quality Management Practices in Improving the Efficiency and Effectiveness of Financial Services .....</b>	<b>189</b>
Lura Rexhepi Mahmutaj .....	189
Gent Jusufi.....	189

Kujtim Zylfijaj.....	189
Arta Koka Grubi .....	189
<b>Information Literacy Primary School Students in the Czech Republic in International Comparison .....</b>	<b>198</b>
PaedDr. Zuzana Horváthová, Ph. D. ....	198
Assoc. Prof. Ing. Josef Abrahám, Ph. D.....	198
<b>Generation Y – Characteristics of Attitudes on Labour Market .....</b>	<b>207</b>
Dr Agnieszka Stanimir .....	207
<b>Career stages and attitudes to skills development process in Poland .....</b>	<b>216</b>
Alicja Grześkowiak.....	216
<b>Trends in the Social Responsibility Expenditures of Small and Medium Enterprises from Oradea .....</b>	<b>226</b>
Tomina Saveanu .....	226
Conf. univ. dr. Maria-Madela Abrudan .....	226
<b>Philosophical Didactics: How Creativity can be Compatible with Critical Thinking .....</b>	<b>233</b>
Jūratė Baranova .....	233
Liutauras Degėsys.....	233
<b>Science Teachers Self Perception about Metacognition .....</b>	<b>244</b>
Mohammed Yousef Mai.....	244
<b>Organizing of Physical Education Teaching Classes and Methods to be Used to Achieve the Intended Objectives .....</b>	<b>255</b>
Rovena Elmazi .....	255
Ledina Koci .....	255
<b>The Role of Finance on Achieving Companies Goals .....</b>	<b>261</b>
PhDc Fatmir Mehmeti .....	261
PhDc , Dr. Sc Pleurat Mustafa .....	261
<b>Different Aspects about the Position of Albanians in Montenegro .....</b>	<b>269</b>
Dr. sci. Veton Zejnullahi .....	269
<b>Workers’ Protests in Northern Portugal in the Transition from the Monarchy to the Republic .....</b>	<b>276</b>
Célia Maria Tabora da Silva .....	276
<b>Identifying the Ethical Issues in Research and the Process of Gaining the Scientific Titles .....</b>	<b>281</b>
Hasan Jashari.....	281
<b>Language Selectivity in Lexical Access: an Experimental Study on Bilinguals .....</b>	<b>288</b>
Fatma Demiray .....	288
Dilek Peçenek.....	288
<b>Education Challenges and Developments in Foreign Language Teaching in Croatian Law Schools Education Challenges and Development for the Future .....</b>	<b>317</b>

Ljubica Kordić .....	317
<b>Back to Work with Small Children Comparative Analyses of Maternity/Paternity Leave in the Member States of the European Union .....</b>	<b>327</b>
PhD Simona Maria Stanescu, .....	327
<b>Teacher’s Suggestions for Recycling and Sustainable Environment: Reflections on Diaries .....</b>	<b>345</b>
Assoc. Prof. Dr. Dilek ERDURAN AVCI .....	345
Assist. Prof. Dr. Huriye DENİŞ ÇELİKER .....	345
<b>How Sensitive are Indonesian Customers to Sexual Appeal Advertising? (a Study of the Axe TV Commercial, “Heaven on Earth”) .....</b>	<b>355</b>
Diana Sari .....	355
Winton .....	355
Philip Trebilcock .....	355
<b>Environmental Injustice in Pakistan: Impacts of Upstream Dams on Indus Delta and its Inhabitants .....</b>	<b>363</b>
Abdul Hadi .....	363
<b>How Many Children Would You Like to Have? Exploring Romanian Fertility Decline .....</b>	<b>369</b>
Iulian Stănescu .....	369
<b>Fiscal Policies Applied in Kosovo and Their Impact in the Competitiveness in Kosovar Businesses .....</b>	<b>380</b>
Skender Hasani, PhD Cand. ....	380
<b>Student Engagement in Fostering Quality Teaching in Higher Education .....</b>	<b>389</b>
Dražena Gašpar .....	389
Mirela Mabić .....	389
<b>The Impacts of Political and Economic Uncertainties on the Tourism Industry in Turkey</b>	<b>397</b>
Ebru Tekin .....	397
<b>Functional Textile Preferences of Elderly People .....</b>	<b>407</b>
Sema Palamutcu .....	407
Imren Goren .....	407
<b>Age as a Determining Factor in L1 and L2 Acquisition .....</b>	<b>416</b>
Antonija Šarić .....	416
Lidija Obad .....	416
<b>Pedagogical Content Knowledge among the Teachers of Special Classes of Reading and Memorizing the Qur’an (KKQ) in Kuala Lumpur. ....</b>	<b>430</b>
Aznil Hashim .....	430
<b>A Qualitative Study on the Application of Problem-Based Teaching Theory on Music Education: the Example of Artvin Çoruh University .....</b>	<b>443</b>
Prof. Dr. Ömür BÜTEV DOLĞUN .....	443

<b>Is It Easier for Minority Groups to Integrate in the Work Force When They are Self-Employed? a Case Study in the Israeli Labor Market .....</b>	<b>450</b>
Tal Shahor.....	450
<b>Comparing 2011 General Election and 2014 Presidency Election in Turkey with Regard to Political Marketing .....</b>	<b>460</b>
Hakan Yaş .....	460
Yasin Usta .....	460
Sedef Zeyrekli Yaş.....	460
<b>Elections and Implementation of the Law of Elections in Albania .....</b>	<b>473</b>
Prof. As. Dr. Ilir Berhani .....	473
<b>Cultural Specifics of Life Values and Subjective Well – Being .....</b>	<b>482</b>
Elena Chebotareva .....	482
<b>Geographic Information Systems (GIS) in Urban Planning .....</b>	<b>491</b>
Ph.D. Sonila Xhafa .....	491
Ph.D. Albana Kosovrasti .....	491
<b>Exercise Habits of Women 40 Ages and Over .....</b>	<b>499</b>
Assoc. Prof. Dr. Fatma Çelik Kayapınar .....	499
Ece Ergen.....	499
<b>Creative Thinking -Perception of Teachers in Relation to its Importance.....</b>	<b>503</b>
Dr. Shqipe Haxhihyseni .....	503
<b>Differential Roles between Owner and Manager in Financial Practice that Contributes to Business Success: an Analysis on Malaysian Small Business .....</b>	<b>510</b>
S. M. Ferdous Azam.....	510
Moha A. Abdullah.....	510
<b>Polysemy and Homonymy Seen in Their Stylistic Use .....</b>	<b>525</b>
Sonila Daiu, PhD. Cand. ....	525
<b>Qenia Kombëtare e Shqiptarëve e Përthyer Përmes, Përtej dhe Përkundër Mitit .....</b>	<b>531</b>
Dr. Ismail Stafa .....	531
Bedri Kaza.....	531
<b>How Long Will Global Economic Crisis Last? .....</b>	<b>540</b>
Sabri Gashi.....	540
<b>Enhancing Youth Employability as a Result of Creating Linkages between Vocational Education Sector and Private Agricultural Sector in Kosovo .....</b>	<b>546</b>
PhD(c) Emine Daci - Zejnullahi, PhD(c).....	546
Petrit Bushi.....	546
<b>The Interdisciplinary Possibilities of Literary and Visual Creation: the Case of Jurga Ivanauskaite .....</b>	<b>561</b>
Jūratė Baranova .....	561
<b>Women’s Political Participation in some of the Western Balkan Countries .....</b>	<b>575</b>

---

Abdula Azizi .....	575
<b>Influence of Third Opinion Leaders on Decision Making Quality: a Case on Financial Decision Making .....</b>	<b>582</b>
Nik Maheran Nik Muhammad, DBA .....	582
Rikinorhakis Ridwan .....	582
<b>Synchronization Possibilities and Features in Java .....</b>	<b>594</b>
Beqir Hamidi .....	594
Lindita Hamidi .....	594
<b>Comparison of the Three Welfare States in terms of Health Clinic Standarts .....</b>	<b>604</b>
Visar Ismaili .....	604
<b>Motivating Reading Comprehension .....</b>	<b>612</b>
Assoc. Prof. Dr. Petraq Vasil Buka .....	612



## The Effect of Psycho Education Program for Prevention of Test Anxiety on 8th Grade Students to Reduce Anxiety and Indecisiveness

**Mehmet Kaya**

Research Assistant, Bingol University,

Psychology Department,

[uzm.psk.dan@gmail.com](mailto:uzm.psk.dan@gmail.com) Tlf: 00905302758223

### Abstract

*This study aims to investigate the effect of psycho-education program on reducing the test anxiety and personal indecisiveness. The study was carried out with a group of ten 8th class volunteer students whose test anxiety scores were high. The test anxiety which is one of the study's variables was tested with Test Anxiety Inventory (TAI) that is adapted to Turkish by Öner (1990). Besides, Personal Indecisiveness Scale (PIS) that was developed by Bacanlı (2000) was applied. The Psycho-education Program to the group was applied in 7 sessions. The study is semi-experimental and depended on pre-test, last-test model. Wilcoxon's signed rank test was used to analyze data and .05 significance level was used as criteria in interpreting results. As a result, it was observed that psycho-education program to 8th class students is effective on reducing: the test anxiety scores of students; personal indecisiveness; (implicitly) social anxiety and increasing self-reliance.*

**Keywords:** Test Anxiety, Anxiety, Psycho-educational Groups

### Introduction

Education is a process of making desired changes intentionally in one's life through experience (Ertürk, 1986). To define education in its widest meaning, it is "raising human" (Fidan, 2012; Totan & Yavuz, 2009). This raising process happens in two ways as formal and informal.

Formal education is conducted by a teacher in a special area from the beginning to the end of the process. It is carried on within a pre-determined program. Informal education is a haphazard process that is not intentional and planned and takes place in the life. The person is affected by the environment in which he or she lives, interacts, and learns (Fidan, 2012). Therefore, results of the formal education is always desired, while it is hard to say the same for the informal education. For example, incidents like cheating, slanging and smoking happen haphazardly and are undesired aspects of the informal education (Fidan, 2012; Senemoğlu, 2009; Şahin, 2007; Totan & Yavuz, 2009).

Teaching is giving pre-determined targets to a person in the responsibility of teachers (Senemoğlu, 2009; Totan & Yavuz, 2009). These two concepts brings us to another important concept: learning. Because, the main purpose of education and teaching is enabling learning. Therefore, learning can be explained as the product of person's life, permanent changes in behaviour and the process of gaining new behaviours (Senemoğlu, 2009; Şahin, 2007; Totan & Yavuz, 2009). Finally, guidance is a process that includes helps of experts in order to make people happy and productive and to reach required qualities (Erkan, 2006).

To understand the test anxiety, these concepts must be understood well. Because, test anxiety has many dimensions (Erözkan, 2009; Totan & Yavuz, 2009). Those dimensions are increased level of knowledge, educational system, life periods, attitude of teacher, expectation of family and society, socio-economical level etc. For example, evaluation process which is the last period of teaching process may lead many problems (Totan & Yavuz, 2009). Also, increased level of knowledge and its spread make it difficult for adolescents who are in the education-teaching process to adapt different situations (Çapulcuoğlu & Gündüz, 2013).

As the formal part of education is considered, it is known that attitude of teacher towards lecture, towards student and student's attitude towards lecture proportionately has effect on increase or decrease of test anxiety (Şahin, Günay & Batı 2006). To give example from informal part, academic success of student – it was expressed by many researchers (Bacanlı

& Sürücü, 2006; Erözkan, 2004; Totan & Yavuz, 2009) that test anxiety is meaningful to predict success- is affected by students' family, environment he lives in and from society life. All those factors have press on student (Adana & Kaya, 2004; Erözkan, 2009; Grzesiak-Feldman, 2013; Totan & Yavuz, 2009; Yıldırım, 2000). Actually, the press is not only on student but also on his or her family. That is, because of cost of living and limited job opportunities, academic success is important for student and his or her family and concerns student as well as society life.

Development of a society depends on raising academically successful and qualified people. In this point of view, investments that are made in education actually are made in development of society in long term (Yıldırım, 2000). It is known that, education is a multi variable, theoretical and experimental science. Therefore, educational settings must be controlled consistently and deficiencies be evaluated and removed in order to reach targets (Sönmez, 1987). Only in this way academically successful and qualified people can be raised. However, an important number of academically successful students can not prove their success because of the test anxiety (Baltaş & Baltaş, 2002). Considering that, exams are important evaluation tools in Turkey's education system (Şahin, Günay & Batı 2006; Totan & Yavuz, 2009) the situation can be understood better –and it must be because of this reason that test anxiety is one of the most mentioned and researched topics (Carrol & Fisher, 2013; Sparfeld, Rost, Baumeister & Christ, 2013; Yöndem, 2011). There are researches in literature related to understanding anxiety before exams and coping with the anxiety related problems (Lowe ve ark. , 2008; Meijer, 2001).

Many researchers (Kuzgun, 1986; Bacanlı & Sürücü, 2006; Büyükgöze-Kavas, 2012; Fuqua, Newman & Seaworth, 1988; Kimes ve Troth, 1974) mentioned that there is a close relation between anxiety and indecisiveness / decision making skills. It is known that decision making behaviour is confronted in every part of life (Çakır, 2004; Çolakkadıoğlu & Güçray, 2012). The situation of "being at peace with himself/herself" which is a criteria of being a healthy person is shaped with decisions made by the person (Çakır, 2004; Çolakkadıoğlu & Güçray, 2007). Feelings before and after decision are not always positive and may cause other problems. A right decision made by person saves him or her from complex and worry so that it facilitates the situation of being happy. Making a right decision is possible by reaching right information and evaluating reached information (Çakır, 2004).

Test anxiety can be defined as perceived threat to physiological, cognitive and emotional condition that a person experiences in situation of being evaluated during his or her academic life (Bruman-Fulks, Berman, Martin, Marsic & Haris, 2009; Carrol & Fisher, 2013; Erözkan, 2004; Erözkan, 2009; Piji Küçük, 2010; Totan & Yavuz, 2009). Researchers mentioned two dimensions of this threat: worry and emotionality (Sparfeld, Rost, Baumeister & Christ, 2013). Worries are cognitive dimensions of anxiety and are a person's negative judgements about himself or herself. Emotionality is physiological dimension of anxiety. It includes sweating of hands, fast heartbeating, feeling cold and turning red (Erözkan, 2009; Piji Küçük, 2010; Totan & Yavuz, 2009 Yöndem, 2011; Yurdabakan, 2012). Almost everybody feels a small quantity of anxiety, but this is a desired anxiety and leads to success (Piji Küçük, 2010; Yöndem, 2011). On the other hand, undesired test anxiety is perceiving the test as life and death issue because of reasons such as; thought of not finishing the test in time, fear of failure, thought of not comprehending the test, feeling guilty resulted from thought of not studied well, thought of desperating his or her relatives, hyper activity and nausea (Piji Küçük, 2010; Şahin, Günay & Batı 2006). Since this situation is perceived as the most serious barrier to success (Adana & Kaya, 2004), it leads to psychosomatic illnesses, a depressive personality (Bruman-Fulks, Berman, Martin, Marsic & Haris, 2009; Erözkan, 2009; Piji Küçük, 2010; Totan & Yavuz, 2009) and negative personal specialties like low self-esteem and neurotism (Bacanlı & Sürücü, 2006).

In many researchs it was found out that there is a negative relation between desired decision making styles and anxiety which lays in the basis of personality theories. While there is positive relation between maladaptive styles and anxiety (Fuqua, Newman & Seaworth, 1998). Similarly, Kimes ve Troth (1974) stated there is a negative correlation between continuous anxiety and decisive manner. In a study on the 8th grade students carried out by Bacanlı & Sürücü (2006) it was seen that students' decision making styles which are used to cope with making decision have an important role on the test anxiety. Also as other studies are investigated it can be seen that indecisive students generally are more anxious (Kuzgun,1986), dependent, have low self-sufficiency compared to decisive students (Büyükgöze-Kavas, 2012).

However, there is no research that includes anxiety and indecisiveness at the same time or investigates the effect of psycho-education programs on indecisiveness for preventing test anxiety. In this context, this study is expected to make a contribution to the literature.

Exams are processes that students must overcome during education-training process (Çapulcuoğlu, & Gündüz, 2013). Therefore, there are many duties relate to school guidance services to help students become productive persons for the society (Adana & Kaya, 2004; Erözkan, 2009; Totan & Yavuz, 2009; Yıldırım, 2000). One of these duties is helping students through group guidance or setting up psycho-educational groups.

## Method

### Research Design

This research is a semi-experimental study that is carried out to decrease anxiety and indecisiveness of 8th grade students with psycho-educational program for preventing test anxiety. The study is single group, based on pre-test, last-test model and was applied in sessions lasted 1-1.5 hour a week and continued for 7 weeks.

### Study Group

Survey was conducted during 2013 – 2014 academic year with 50 students who are in the learning process in a secondary school within Sur Central district in Diyarbakır. Test Anxiety Inventory (TAI) adapted to Turkish by Öner (1990) and Personal Indecisiveness Scale (PIS) developed by Bacanlı (2000) was applied to 8th grade students in order to determine students who will participate in the sessions. The study group was chosen according to points gained from these scales. 15 students whose anxiety and indecisiveness level is the highest were interviewed and given information about the aim of the study. The study was conducted with 5 girls and 5 boys 10 students in total who stated they were volunteer for the program. They all participated to all sessions except absence of two students in the termination session because of familial reasons.

### Data Collection Tools

Test Anxiety Inventory and Personal Indecisiveness Scale were used in the study to collect data. Measurement tools were applied as pre-test last-test.

TAI is with 4 point Likert type inventory and consists of 20 items with subtests; “worry (12 items)” and “emotionality (8 items)”. Points gained from TAI changes between 20 – 80. TAI was developed by Spielberger and its Turkish translation, reliability and validity was tested by Öner (1990). High points gained from TAI means that test anxiety is also high.

PIS is with 5 point Likert type scale and consists of 18 items with two independent subscales; “investigator indecisiveness (10 items)” and “pushy indecisiveness (8 items)”. Points gained from PIS varies between 18 – 90. Reliability and validity tests of PIS was done by Bacanlı (2000). High points gained from PIS shows that indecisiveness level is also high (Kuzgun & Bacanlı, 2011).

### Process Path

To determine participants, 10 volunteer students were chosen from 50 students whose anxiety level was the highest. Seven sessions were held lasting 1-1.5 hours with each student from the group. Group guidance program which exists in the I. Volume of book named Experimentally Proved Psychological Counselling and Guidance Program that was printed for the third time by Pegem Akademi in 2012 and whose editors were Serdar Erkan and Alim Kaya was utilized.

Psycho-educational program lasted seven session and it goes like this:

In the first session, participants of the group were introduced to each other, aims and rules of the group and expectations, feelings about the group were expressed, moreover basic information about test anxiety was given in order to make participants understand the relation between anxiety and success. In the second session, it was focused on perception of changes in body during or before exam, also focused on relaxation technique so that it was aimed participants to control their bodies during situations that make them anxious. In the third session, the aim for participants was using their their times according to their priorities and developing an understanding for this purpose so that they can prepare daily and weekly schedule for studying. In the fourth session, the focus was on comprehending developed methods with active listening as well as reading faster and more efficient. In the fifth session, the focus was on “ISOAT (Survey, Question, Read, Recite, Review)” technique aiming participants to comprehend methods for effective reading. In the sixth session, the focus

was on grasping “Mental Regulation Technique” used for regulating irrational thinking manner in order to make students realize their irrational beliefs and change them with rational thoughts. In the seventh session, the aim was to make students comprehend “Exam Taking Skills” and focus on understanding “15 Attack Methods” to be successful in the exams, and then came the termination session.

### Analyzing Data

In the beginning of the research, Wilcoxon Signed Ranks Test was used to determine whether there is a meaningful difference between points gained from TAI and PIS pre-test last test measurements. In the interpretation of results .05 meaning level was used as criteria.

### Findings and Interpretation

In this chapter, there are statistical data analyse processes and results to put forward whether psycho-educational program for reducing test anxiety is effective on reducing test anxiety and personal indecisiveness levels of 8th grade students.

#### Findings Related to Test Anxiety Inventory

In Table 1 there is analyse of Wilcoxon Signed Ranks Test for determining whether there is a meaningful difference of students test anxiety level according to pre-test last test points.

Table 1. findings regarding the difference between pre-test last test points of students test anxiety .

Tests	N	$\bar{X}$	Ss	Z	p
Pre- Test	8	57,12	8,49	-2,527	,012
Last Test	8	36,62	5,87		

When analyzing Table 1. , it can be seen that there is a meaningful difference between test anxiety points before and after the application ( $z = -2.527, p < .05$ ). Difference points being in favour of negative pairs (measurement in the beginning) shows that the program has a meaningful effect in reducing test anxiety.

#### Findings Regarding Personal Indecisiveness Scale

In Table 2. there is analyse of Wilcoxon Signed Ranks Test for determining whether there is a meaningful difference of students personal indecisiveness level according to pre-test last test points.

Table 2. findings regarding difference between pre-test last test points of personal indecisiveness of students in Psycho-educational program.

Tests	N	$\bar{X}$	Ss	Z	p
Pre-Test	8	54,00	10,16	-2,521	,012
Last Test	8	40,87	15,51		

When analyzing Table 2. , it can be seen that there is a meaningful difference between personal indecisiveness points before and after the application ( $z = -2.521, p < .05$ ). Difference points being in favour of negative pairs (measurement in the beginning) shows that the program has a meaningful effect in reducing personal indecisiveness.

The main purpose of the study is testing the effect of psycho-educational program for reducing test anxiety and personal indecisiveness of participants. To determine realization of this aim, points of scale and inventory that was applied to the group were compared. Because, in both measurement tools, highness of points is undesired situation. Therefore, as

Tables given above were investigated it can be mentioned that the program is effective on reducing test anxiety and personal indecisiveness.

### **Conclusion, Arguement and Proposals**

In this chapter, findings regarding the effects of applied psycho-educational program for students' test anxiety and personal indecisiveness were argued and proposals were made in this context.

The first finding from the study shows that psycho-educational program has an effect on reducing test anxiety of students of the group. Yurdabakan (2012) in his study named The Effect of Group Guidance Program on 8th Grade Students' Test Anxiety Levels mentioned activities such as informing, relaxation exercises, exam taking skill, cognitive behavioral techniques, efficient studying skill and showed that group guidance program is effective on reducing test anxiety. Another study which is similar to this in terms of content and result was carried out by Erkan (1994). In this context it can be stated that this study has similar results to present studies.

Another finding from the study shows that psycho-educational program for reducing test anxiety has an effect on reducing personal indecisiveness of students of the group. Although, there is no study investigating effect of psycho-educational program for reducing test anxiety on personal in/decisiveness in the literature, there are few studies investigating relation between anxiety and decision makin styles / strategies. In the study of Bacanlı & Sürücü (2006) on 8th grade secondary school students and study of Dereli & Acat (2011) on students of Pre-School Teaching Department it was seen that decisin making skills can predict test anxiety. It can be understood vice versa with the present study.

Furthermore, it was observed that (both at the end of session and during termination phase "general evaluation of all sessions") secondary aims such as solving lackness of self expression, self confidence and social anxiety were affected by psycho-educational program. These secondary aims exist in "session diaries" which are given to students as homework during the process, and contain the summary of every session, and will stay with them. Öner (1990) stated that, students who has test anxiety are stressful, nervous and fearful not only during exams, but also during activities in the group like speaking, participating arguements, anwering questions, reading aloud. In this context, reduce in students test anxiety may lead to reduce in problems like lackness of self expression, self confidence, and social anxiety. Therefore, the statement of Öner (1990) support the indirect effect of psycho-educational program. Moreover, benefit of education and psycho-educational program to students were found out by other researchers (Çivitçi, 2005; Çolakkadioğlu, 2010; Çolakkadioğlu & Güçray, 2012).

### **Proceeding from these findings below proposals were made:**

- 1.This study showed that the psycho-educational program for prevention of test anxiety is effective on personal in/decisiveness. The effect of psycho-educational program for development of decision making skills might be investigated in a similar way.
- 2.As number of psychological counselors and number of students are considered a 10 sessioned program in which two variables are studied at the same time would be developed, instead of applying to each group test anxiety psyccho-educational program and decision making psyccho-educational program differently. Hereby, it would be possible to save time and labor force and the number of students reached would increase.
- 3.This study was limited to 8th grade students. Other researchers can apply similar psyccho-educational programs to different ages and wider sample groups.
4. Students are considered not to be neglecting their homeworks during psyccho-educational program, and it is thought that this situation has increased efficiency gained from the group (depending on the result of pre-test last test). Researchers who will make similar studies are advised to use homeworks efficiently.
5. In this study absence of control group and absence of following process is a limitation. Therefore, it is possible to set up control group and do following process in order to increase effectiveness in other similar researches.

**References**

- Adana, F. & Kaya, N. (2004). Lise öğrencilerinin sınav kaygısı düzeyi üzerine sınav kaygısıyla başa çıkma eğitiminin etkisi, *Kriz Dergisi* 13 (2), 35–42
- Bacanlı, F. , & Sürücü, M. (2006). İlköğretim 8. sınıf öğrencilerinin sınav kaygıları ve karar verme stilleri arasındaki ilişkilerin incelenmesi. *Kuram ve Uygulamada Eğitim Yönetimi Dergisi*, 12 (1), 7-35.
- Baltaş, A. , & Baltaş, Z. (2002). *Stres ve başa çıkma yolları*. Remzi Kitabevi.
- Broman-Fulks, J. J. , Berman, M. E. , Martin, H. M. , Marsic, A. & Haris, J. A (2009). Phenomenon of declining anxiety sensitivity scores: A controlled investigation, *Depression and Anxiety*, 26, 1–9
- Büyükgöze-Kavas, A. (2012). Kariyer karar ölçeği'nin Türkçe uyarlaması: Geçerlik ve güvenilirlik çalışması. *Türk Psikolojik Danışma ve Rehberlik Dergisi*, 4 (38), 159-168.
- Carol, P. J. O & Fisher, P. (2013). Metacognitions worry and attentional control in predicting OSCE performance test anxiety, *Medical Education*, 47, 562–568
- Çakır, M. A. (2004). Mesleki karar envanterinin geliştirilmesi. *Ankara Üniversitesi Eğitim Bilimleri Dergisi*, 37 (2), 1-14.
- Çapulcuoğlu, U. & Gündüz, B. (2013). Öğrenci tükenmişliğini yordamada stresle başa çıkma sınav kaygısı akademik yetkinlik ve anne baba tutumları, *Eğitim Bilimleri Araştırma Dergisi*, 3 (1), 201–218
- Çivitci, A. (2005). Akılcı duygusal eğitimin ilköğretim öğrencilerinin mantık dışı inanç, sürekli kaygı ve mantıklı karar verme düzeylerine etkisi. *Ege Eğitim Dergisi*, 6, 59-80.
- Çolakkadioğlu, O. (2010). Çatışma kuramına dayalı olarak geliştirilen karar verme beceri eğitimi grup uygulamalarının ergenlerin karar verme stillerine etkisi. *Yayımlanmamış Doktora tezi, Çukurova Üniversitesi, Sosyal Bilimler Enstitüsü, Adana*.
- Çolakkadioğlu, O. , & Güçray, S. S. (2012). Çatışma kuramına dayalı olarak geliştirilen karar verme beceri eğitimi psiko-eğitim grup yaşantısının ergenlerin karar verme stillerine etkisi. *Kuram ve Uygulamada Eğitim Bilimleri Dergisi*, 12 (2), 655-676.
- Çolakkadioğlu, O. , & Güçray, S. S. (2007). Ergenlerde karar verme ölçeğini Türkçe'ye uyarlama çalışması. *Eurasian Journal of Educational Research (EJER)*, (26).
- Dereli, E. , & Acat, M. B. (2011). Okulöncesi öğretmenliği bölümü öğrencilerinin karar verme stratejileri ile sınav kaygıları arasındaki ilişki. *Eskişehir Osmangazi Üniversitesi Sosyal Bilimler Dergisi*, 12 (2), 77 - 87
- Erkan, S. (2006). Rehberlik nedir. ,Y. Kuzgun (Ed). İçinde. *İlköğretimde Rehberlik. Altıncı Baskı. Ankara: Nobel Yayınevi*, ss. 1–16
- Erkan, Z. (1994). Grup rehberliği'nin yüksek sınav kaygısına etkisine yönelik deneysel bir çalışma. *Yayımlanmamış Yüksek Lisans Tezi, Sosyal Bilimler Enstitüsü, Çukurova Üniversitesi, Adana*.
- Erözkan, A. (2004). Üniversite öğrencilerinin sınav kaygısı ve başa çıkma davranışları. *Sosyal Bilimler Enstitüsü Dergisi*, 1 (12), 13 – 38
- Erözkan, A. (2009). İlköğretim sekizinci sınıf öğrencilerinde depresyonun yordayıcıları, *Elementary Education Online*, 8 (2), 334–345
- Ertürk, S. (1986). *Eğitimde program geliştirme*. Ankara: Yelkentepe Yayınları.
- Fidan, N. (2012). *Okulda öğrenme ve öğretme*. PegemAkademi Yayınları
- Fuqua, D. R. , Newman, J. L. , & Seaworth, T. B. (1988). Relation of state and trait anxiety to different components of career indecision. *Journal of Counseling Psychology*, 35 (2), 154.
- Grzesiak-Feldman, M. (2013). The effect high-anxiety situation on conspiracy thinking, *Current Psychology*, 32, 100–118

- Kimes, H. G. , & Troth, W. A. (1974). Relationship of trait anxiety to career decisiveness. *Journal of Counseling Psychology*, 21 (4), 277.
- Kuzgun, Y. & Bacanlı, F. (2011). *Rehberlik & Psikolojik Danışmada Kullanılan Ölçekler* (3. Baskı). Ankara: Nobel yayın dağıtım
- Kuzgun, Y. (1986). Meslek seçiminde kararsızlık. *Ankara Üniversitesi Eğitim Fakültesi Dergisi*, 217-223
- Lowe, P. A. , Lee, S. W. , Witteborg, K. M. , Prichard, K. W. , Luhr, M. E. , Cullinan, C. M. , . . . & Janik, M. (2008). The test anxiety inventory for children and adolescents (TAICA) examination of the psychometric properties of a new multidimensional measure of test anxiety among elementary and secondary school students. *Journal of Psychoeducational Assessment*, 26 (3), 215-230.
- Meijer, J. (2001). Learning potential and anxious tendency: Test anxiety as a bias factor in educational testing. *Anxiety, stress and Coping*, 14 (3), 337-362.
- Öner, N. (1990). *Sınav Kaygısı Envanteri El Kitabı*. İstanbul: Yöret Yayınları.
- Piji Küçük, D. (2010). Müzik öğretmeni adaylarının sınav kaygısı benlik saygısı ve çalgı başarıları arasındaki ilişkinin incelenmesi, *Ahi Evran Üniversitesi Eğitim Fakültesi Dergisi*, 11 (3), 37–50
- Senemoğlu, N. (2009). *Gelişim Öğrenme ve Öğretim Kuramdan Uygulamaya* (15. Baskı). Ankara: Pegem A yayıncılık
- Sönmez, V. (1987). Eğitim ortamında sevgi. *Hacettepe Üniversitesi Eğitim Fakültesi Dergisi*, 2 (2). 65 - 77
- Sparfeldt, J. R. ,Rost, D. H. , Baumeister, U. M. & Christ, O. (2013). Test anxiety in written and oral examinations, *Learning And Individual Differences*, 24, 198–203
- Şahin, A. E. (2007). Eğitimle ilgili temel kavramlar. ,V. Sönmez (Ed). İçinde. *Eğitim Bilimine Giriş. Üçüncü Baskı*. Ankara: Anı Yayıncılık, ss. 1–24
- Şahin, H. , Günay, T. & Batı, H. (2006). İzmir İli Bornova İlçesi Lise Son Sınıf Öğrencilerinde Üniversiteye Giriş Sınavı Kaygısı. *Sted* 15 (6), 107–113
- Totan, T. & Yavuz, Y (2009). Westside sınav kaygısı ölçeğinin Türkçe formunun geçerlik ve güvenilirlik çalışması, *Mehmet Akif Ersoy Üniversitesi Eğitim Fakültesi Dergisi*, 9 (17), 95–109
- Yıldırım, İ. (2000). Akademik başarının yordayıcısı olarak yalnızlık sınav kaygısı ve sosyal destek, *Hacettepe Üniversitesi Eğitim Fakültesi Dergisi* 18, 167 – 176
- Yöndem, Z. D. (2011). *Kişilik Dinamikleri ve Stresle Baş etme* (2. Baskı). Ankara: Efil yayınevi
- Yurdabakan, İ. (2012). Grup rehberliği programının ilköğretim sekizinci sınıf öğrencilerinin sınav kaygısı düzeylerine etkisi. S. Erkan, & A. Kaya, (Ed. ) içinde. *DeneySEL olarak sınanmış Grupla Psikolojik Danışma ve Rehberlik Programları I. Cilt, Üçüncü Baskı*. Ankara: PegemAkademi yayınları

---

## Unequal Itineraries for Graduates: a Typology of Entrance into Labour Market

**Ana Paula Marques**

Associate Professor, PhD of Sociology

(University of Minho/Portugal),

Senior Researcher in the Interdisciplinary

Centre of Social Sciences (CICS. NOVA. UMinho),

amarques@ics.uminho.pt

### Abstract

*In the transition from higher education to the labour market, the critical correspondence between qualification and first job, as well as precariousness and/or unemployment experiences has been a crucial topic of understanding of labour market as one of the main facets of social and socio-economic insecurity and risks in contemporary European societies. In this paper we intend to contribute to the debate on unpredictable itineraries of professional integration of graduates from Higher Education which reveals simultaneously and differently patterns of employability and professionalization segments. By mobilising some of the research outcomes of the projects lead by us, it is our purpose to cross contributions from the sociology of professions and employment in order to analyse the main social forms of entrance into labour markets. Based on the articulation of two axes, namely, social regulation and professional mobility, which are structured in a continuum in abstract terms, four "ideal-types" of social forms were defined: professional markets, internal markets, transitional markets and secondary markets (in neoclassic terms). In that sense, main exploratory analytic dimensions were mobilised on four levels: symbolic (recognition and the importance of academic title, identity and integration), cognitive (expertise and professional experience), social-political (dominant contractual status, market independency) and organizational (career/hierarchical position).*

**Keywords:** Graduates, Labour market, Social regulation, Career mobility.

### Introduction

It is common knowledge that the last decades have been deeply influenced by crucial changes in globalised labour market. These changes have led, to a greater or lesser extent and depending on the specific country, to the increased flexibility and precariousness of labour market, to the segmentation of the workforce and the development of "atypical" forms of employment as opposed to the dominant model in the wage-based post World War II period. Until then, the typical relationship was based on employment stability by contractual basis which underlies the collective agreement of work and compliance of criteria such as: i) the durability of the employment relationship, ii) the uniqueness of the employer and, belonging to an organized service; iii) working full-time with an equivalent wage (Foucarde, 1992). It defined therefore, the profile of what has come to be socially and legally designated as wage "typical" employment, setting the standard of employment (permanent, full-time and social protection). In this sense, they are considered "atypical" situations all of which do not check one or other or all of those criteria. Overall, these atypical forms of work can range from simple undeclared activities (in the form of "concealed employment" which, although not illegal in itself, is not declared to one or more administrative authorities who should be aware of it and that, in this way, is absent from regulation and taxation or reduction of social security benefits) forms of temporary, full time or part-time contracts (Célestin, 2000).

While it is true that the results of several researches seem to point to some different occupational transitions that include different working conditions and heterogeneous statutes - which reveal, on the one hand, the growth achieved in the search for graduates by business employers (Diana & Marques, 2014; Marques, 2010, 2007) - it is also true that employers tend to focus on recruitment arrangements and worker management close to a quantitative flexibilization by the increased mobilization of employment forms that go beyond the "typical norm". Therefore, it is possible to identify three major trends that affect graduates' professional transitions.



First of all, the recent transformation in educational and productive systems has changed the practices and references associated with the processes of "entry into adulthood" (Galland, 1997, 1996, 1984 ) or professional transition of youths, especially the graduates who tend to have nonlinear trajectories (e. g. training, employment, unemployment and inactivity) affecting the transformation of traditional representations of employment and occupation.

Secondly, we are witnessing a phenomena regarding the extension in the time of studies (initial training and lifelong learning) as well as intermediate and precarious positions until the achievement of a stable position in the labour market (Marques, 2006). The duration of these processes becomes itself a structuring factor of occupational transition, defined by the diversity of situations, statutes or conditions (e. g. fellow researcher, trainee, independent worker) that prevail in recurrent situations of vulnerability and precariousness in relation to employment.

Finally, these practices and references related to professional transition extend through non-linearity, resulting in a desynchronization of the various axes of professional emancipation, personal and family life.

These trends have led modern societies to make changes in the labour market processes or towards a transitional labour market (Schmid, 2000), in which the demarcation lines between work, leisure, education and care have been blurred, leading to increased mobility and flexibility, de-standardization of the course of life and to an overall focus on employability.

Taking into consideration this background, the research reported here explores main traits of transformation of the educational contexts and labour markets, in order to bring light to the social structural conditions in which young graduates are been enrolled in unpredictable professional itineraries. Therefore, we will start by presenting the main traits of transformation of the educational contexts. Next, on a second topic, we will perform a reflection on how those professional itineraries reveal simultaneously and differently patterns of employability and professionalization segments. Finally, a proposal to systematise the main social forms of access to employment/profession is presented, assuming two analytical axes in its conceptualisation: 1) social regulation and setting of professional jurisdictions; and 2) organisational and professional mobility. This is a typological essay, which identifies four "ideal types" of important labour markets for graduates: professional markets, internal markets, transitional markets and secondary markets (neoclassical sense).

## 1. Expansion of Higher Education: Shifts and Tensions

The expansion of higher education and the gradual increase of graduates have been followed by empirical evidence that points to the possibility of obtaining a qualified job linked to higher education levels (Diana & Marques, 2014; Tomlison, 2013, 2009; Smyher *et al.* , 2001; Iannelli & Soro Bonmati, 2003; Machin & MacNally, 2007). However, access to the labour market does not present itself as being uniform and stable to most young adults.

Until now, public policies have pursued certain objectives aiming to influence the education system to enlarge and to improve the opportunities for professional regulated education, whether at secondary and post-secondary levels (with the reintroduction of technical and technological teaching in secondary school) and in higher education, so as to carry out the demands of employability and internationalization among others, envisaged by the Bologna Declaration. It is expected that it will be possible, then, to identify politically relevant scientific areas (and therefore eligible for accruing public funding), to increase student mobility within Europe, to set mutually recognizable diplomas as soon as a degree equivalence is ensured, and also to give more dynamism to scientific and academic networks in the European context.

However, there are different approaches to this problem, according to the countries involved (Tomlison, 2012, Teichler, 2007; Jobert, Marry & Tanguy, 1995; Hannan *et al.* 1999, Muller & Gangl, 2003), as most of them are currently confronted with quite similar problems and challenges concerning the more or less predictable effects of these changes in higher education. These transformations are attached primarily to the extent of time spent in the education system (initial and life-long training), which is linked to a relatively recent trend to the feminization of university ranks, in spite of a minor presence in engineering and technology. Besides, it is necessary to consider the consequences, a few of them already predictable while others still latent, related with school *massification* and with the diversification of the courses offered by the education system. As a matter of fact, while providing the entry of student publics that form a more and more heterogeneous universe regarding their social origins, school trajectories, vocations and professional careers, universities must consider not only their curricula and pedagogic practices, but also the professionalization, specialization and research paths involved in their activities.

The organization and structuring of the education system ranks, as well as the devices to gain access to the labour market, presuppose the access to university to relevant information regarding teaching itself and their students' professional future. This will allow them to identify cognitive thinking, process evaluation, relationship factors, and other competencies considered nuclear for designing courses and their curricula. Such knowledge, necessary to all subjects, should give clear directions and take into consideration not only the changes occurring in traditional jobs, but also the mapping of new professions whose frontiers seem more and more imprecise and broadening.

Relationships between academic training and the labour market have been central in (political, educational and scientific) public debates in the last decades. The choice of the approaches privileged in these debates is largely dependent on the political agenda of the most advanced economies (cf. Pedrosa *et al*, 2005). Many of those approaches have been rapidly changing. Illustrative of this is the sequence of priorities ascribed to during the last decades (Teichler, 2007): i) to the contribution of higher education for economic growth; ii) to the dangers of "over-qualification" and of the disarticulation between supply and demand; iii) to the diversity of education and to job opportunities; iv) to the growing incidence of graduate unemployment and to the precariousness of their work and employment conditions; v) to the emphasis on training "key-qualifications"; vi) and finally, to the trend towards the globalization of the young graduates' labour market.

## 2. Professional transitions, segmentation and precariousness

As a social problem with diverse manifestations, the contexts and kinds of professional transitions currently analysed convene other explicative factors in terms of changes in the productive and employment systems. One of them concerns the difficulties of professional insertion that affect graduates, and not just those deprived of academic qualification. Moreover, the relative depreciation of initial training, linked to the "diploma inflation" effect and its correlative devaluation presupposes strategies of quick recycling of "disqualified" symbolic capitals, with particular incidence on the "social capitals" held by candidates to their first job. It is after all, well known that access to the "first job" depends more on the candidate's personal and family network efficiency. Likewise, we should be aware of the trend for a decreasing correspondence between the diploma and the profile required by available jobs, which may explain to a large extent, the growing distortion of students' representations and expectations of forthcoming complex and extended (time and space) trajectories.

In fact, regarding the current constraints of flexibility and globalization of the labour market, most companies expose social groups who have invested in their professional and academic training to growing precariousness. If these are used to present advantages over those who were deprived of such resources, in the current context of deep transformation of the productive and educational systems, employment relationships become much more volatile and non-prescriptive of the conduct of social actors. Certain references of a salary-based society have been weakened, such as those of stability and predictability of professional trajectories, at least to qualified workers with changes in employment situations and conditions, and heterogeneous statuses (e. g. fellow researcher, trainee, part-time, independent worker/task worker). It is known that uncertainty and the instability of the contractual relationship, despite the diverse modalities it may assume according to each country, affect almost an entire generation of men and women and young adults with or without diplomas.

Therefore, today, the focus behind this discussion is on knowing to what extent the professional transition of young graduates has been presenting (in)visibility contours in the labour market, and what its main challenges and (new) employment risks are. Attempts to answer this will enable us to better understand patterns of transition in the labour market, profiles and professionalization areas and demonstrations of skills and relational insights that reinforce the thesis of interchangeability of academic training in contemporary societies. Also, when completing the mapping of these (in)visibility boundaries of this process, it raises the issue of entrepreneurship and its implications towards new professional statutes and in reference to professional identity, particularly by the different leaders and social actors: responsible scholars, policy makers and all individual and collective actors involved in this area (Marques, 2013).

## 3. Social Regulation and Professional Mobility: a Typology of Entrance into Labour Market

### 3.1. Research design information

By mobilising some of the research outcomes of the projects lead by us, namely: “Meintegra” (Integrate me), “Percurso de inserção dos licenciados” (Integration paths of graduates) and “O potencial de empreendedorismo” (The entrepreneurship potential), it is our purpose to cross contributions from the sociology of professions and employment in order to analyse the main social forms of entrance into labour markets.

The first project, “MeIntegra – Mercados e Estratégias de Inserção Profissional de Jovens Diplomados” (Integrate me - Markets and strategies of professional integration of young graduates), carried out between 2006-2007, involved several stages of research and followed three main thematic axes: 1) identification and characterisation of the strategies for professional integration; 2) identification of the practices of mobilisation of the skills by the employers in the framework of a flexible management of labour; 3) understanding and explaining the structural organisational resistances/opportunities for innovation and competitiveness<sup>1</sup>.

The project entitled “Percurso de inserção de licenciados: relações objetivas e subjetivas com o trabalho” (Integration paths of graduates: objective and subjective relations with work) aimed at analysing and interpreting the relations with work in the process of professional transition of graduates during the year 2010/2011<sup>2</sup>.

Finally, the “O potencial de empreendedorismo na Universidade do Minho” (The entrepreneurship potential in the University of Minho) (2010-2012) project, carried out in the framework of the Laboratório MelIntegra spin-off and in the Research Centre for the Social Sciences (CICS/UM), had as main goal to study the potential entrepreneur among the young graduates in the University of Minho<sup>3</sup>.

### 3.2. *Main research findings*

One of the main dimensions concerns the condition of dependence or independence in the contractual relation of the graduates in a labour context. It is important to highlight that the wage earning and the experiences of unemployment transform the real conditions of exercising a profession. In that sense, Evetts (2012, 2010) and Kuhlmann (2012) are unanimous in the diagnosis of the changes in autonomy and independence as foundations of authority of the certified knowledge, the relations of trust and the professional ethos that the several professional groups face in the contemporary world.

Considering our research outcomes, we conclude that the majority of graduates are in a full time employment situation, i. e. , as a wage earner (“MeIntegra”: 71%; “Percurso de inserção dos licenciados”: 89. 3%; “O potencial de empreendedorismo”: 66. 8%). Likewise, if the unemployment percentages are not very expressive at the time, considering our outcomes, the truth is that a growing importance of the phenomenon of “unemployment of insertion” or “standstill in training” of many graduates is verified. This means that the proliferation of the statuses of a research scholarship holder, student or in professional training, among other, without giving a normative and regulatory framework of the labour relation, contributes to making the worsening of the situation of “non-effective professional integration” more visible. Thus, the

---

<sup>1</sup> To write this paper, we will use only the information collected through the questionnaire applied to the graduates of University of Minho located at north of Portugal, who have completed their graduate degrees, in the 2004/2005 academic year (N= 464). For a more profound look of the main outcomes, cf. MelIntegra report at <http://repositorium.sdum.uminho.pt/bitstream/1822/8633/1/MelIntegra%20-%20RepositoriUM.pdf>.

<sup>2</sup> In total, an extensive survey was applied to a sample of 1004 graduates from all the degree courses offered in the Universidade Nova de Lisboa (40.5%) and Universidade de Lisboa (59.5%), both from Portugal, and who have completed their graduate degrees in the 2004/2005 academic year. This project (PTDC/CS-SOC/098459/2008) have presented outcomes of more comprehensive studies that go beyond the purposes of the current paper. However, the fact that we are part of the research team, allows us, for analytical purposes, to study in depth and oppose empirical evidences collected in that research, in order to reinforce the development of the arguments explained in this article.

<sup>3</sup> The online survey was applied to a universe of 1,419 graduates from the University of Minho, who completed the course since 2002 to 2008, from 43 courses that have been grouped into six tracks, according to the National Classification of Education and Training Areas (2008) such as: “Education”, “Arts and Humanities”, “Social Sciences, Business and Law”, “Science, Mathematics and Computer Science”, “Engineering, Manufacturing and Construction”, “Health and Social Protection.” The sample resulted in a 20% quota share, totaling 283 valid surveys.

relative weight of this reality presents the following values: “MeIntegra”: 8%; “Percurso de inserção dos licenciados”: 10.3%; “O potencial de empreendedorismo”: 10.8%.

In what concerns the exercise of a profession as self-employed (self-employed worker/entrepreneur), the records obtained in our research are the following ones: “MeIntegra”: 12%; “Percurso de inserção de diplomados”: 10.4%”; “O potencial de empreendedorismo”: 12.4%. It is known that there are many risks associated with professional paths based on autonomous projects or entrepreneurial careers. These imply individualisation and externalisation of the production costs and all the consequences of contractual instability that come from there, as well as ruptures and imprecisions of borders of professional activity and dismantling of the axes of financial, family and affective emancipation (Marques, 2013).

In another analysis perspective, the enrolment of unpredictable and unequal itineraries facing the labour market passes through these embedding, more and more, generalised practices of visible quantitative flexibility in the use of types of employment, which are different from the “typical norm”, such as mentioned before. According to our results, the most common statuses pass through the existence of shorted-term contracts (fixed-term or of indefinite duration), temporary, traineeship and part-time contracts: “MeIntegra”: 73%; “Percurso de inserção de diplomados”: 52.3%.

Besides these objective practices of labour and social precariousness, we should take into account the dimensions of subjectivity associated with the experiences and different representations by graduates. In the scope of the “MeIntegra” project, it is visible the idea that the academic degree is one of the essential requirements to obtaining a position of success in society. There is the perception that the diploma no longer protects its holder from unemployment, in the same way that certified knowledge and expertise do not end there. The graduate is responsible for investing in further education and in the acquisition of other skills to determine his/her professional success. Likewise, entrepreneurship starts to be seen as a possible solution against unemployment, which reaches more and more the group of graduates. In fact, in the course of the interviews carried out for the “O Potencial de Empreendedorismo” project, the option for self-employment could be understood through the following testimony: “I could give many reasons to go forward, but none of them is the matter of employability. I really like it, ok (...) I am not able to teach, but I am able to do anything else, I have talent for that (...)”. (E2, male, 29 years old, Biology/Geology Teaching). Still reinforcing the importance of the diploma and its relativisation by the simultaneous demands of innovation and risk, note the following quote: “I decided to create a company of environmental engineering services due to my education and the knowledge that I have in this area (...) Usually, entrepreneurship appears when someone has knowledge on a certain area, probably no one creates a company in an area that he/she knows nothing about, otherwise it will fail, but that might not happen... but it has strong probabilities” (E8, male, 30 years old, Environmental Engineering). In opposition, the reason that prevails in the following professional options is necessity: “For example, I would like to open an ATL [after-school recreation centre] or a day care. To begin with, I really like children... and I think it’s harder to get a job (...), and I see, now that I am having a child, that it is harder to get, for example, a day care vacancy” (E3, female, 29 years old, Sociology); “My business sector is clothing, in other words, the creation of a clothing range (...). We will invest in this project because it does not demand a high investment (...). It is a small project, nothing new... We are going to try something and see if it works out (E7, female, 30 years old, Education)”.

In fact, these testimonies reveal important segmentations of professional trajectories, considering both the scientific areas followed by the graduates and the gender. Several studies reinforce exactly the heterogeneity of the statuses and the segmentations assumed by the labour market in terms of gender, type of degree or school qualifications, age, among other (Marques & Alves, 2010; Gonçalves, 2009). This heterogeneity of statuses and professional segmentations has consequences in the perception of daily work, in the anticipation of careers and in the projection of the future.

### 3. 3. A typology of entrance into labour market

Based on previous contributions, the flexibility of labour relations configures the existence of markets endowed with greater or lesser social regulation and/or mobility, which always expresses unequal positions in professional and organisational careers, as well as in the practices of human resources management and specific contexts of socialisation. In this sense, the holders of academic titles stand out, when, in the access to the profession, are confronted with deregulated markets, mainly those peripheral or secondary, although requiring technical and scientific professional performances. In this situation, we are assembling all forms of internships/traineeships, underemployment and contractualisation through “false

green receipts”, which is based on the exteriorisation of the protection of social rights and guarantees in the individual and not in the organisation itself.

Likewise, we can also notice the importance of transitional markets along this segment of graduate labour, in part as a result of the tendency for flexibility and mobility of individuals. In fact, the labour markets are no longer predetermined paths, formatted and fixed beforehand, given the turmoil that affects the decisions of institutional leaders faced with external (e. g. technologies, business restructuring, demographic cycles) and internal (e. g. family exchanges, individual reorientations) circumstances. The constant exits and re-entries, based on a high inter organisational professional mobility at a (trans)national level, constitute traits of the normal functioning of the labour market. With a strong component of a normative/political character, the active policies of employment contribute directly to the shaping of this type of market, which is based on the assumption of targeting its effectiveness from the adjustment to the best individual solutions.

Therefore, the articulation of two axes, namely, social regulation and professional mobility have led us to put forward four “ideal-types” of social forms of entrance into labour market: professional markets, internal markets, transitional markets and secondary markets (in neoclassic terms). In their definition main analytic dimensions were mobilised on four levels: symbolic (recognition and the importance of academic title, identity and integration), cognitive (expertise and professional experience), social-political (dominant contractual status, market independency) and organizational (career/hierarchical position). This analytic proposal is to account for the diversity of social forms that enclose the logical and operational structures of those labour markets in which graduates are currently in circulation. For each of those social forms are presented characteristics that allow their definition and distinction, lacking, however, further work based on future in-depth research.

### Final remarks

The main trends of graduates’ professional transition trajectories found in international researches are confirmed taking into consideration our research findings. The transition of young graduates into the labour market is constrained by cultural, structural and institutional factors at different levels (national and international) and influenced by the education and labour markets of each country. It is also worth remarking that even more important from a cross-national perspective, are the higher educational systems, namely their direct linkage to the labour market or the flexibility of pathways. In fact, the confrontation with the labour market, with the uncertainty and instability of the contractual relationship, despite the different forms that it can take according to the countries, reaches almost an entire generation of qualified (or not) young men and women. The effects of the extension in time and space of this process are manifested in the course of life and in its fundamental stages, in the distinct ways of managing incorporated resources and provisions, expressing margins of freedom contained in a given moment of the personal and collective history, but also by delimiting the field of possibility, the options still available to them.

The paper has presented an exploratory typology of social forms of access to the labour markets in the contemporary world, in order to resist to the homogenising and/or radicalised approaches on the deprofessionalisation/disqualification trends of professional groups. Also, we intend to restore the complexity of the phenomena of labour markets. The conceptual deepening of these recompositions requires, in parallel, their validation with future empirical research. The translation of those analytical axes into research hypotheses will allow evaluating the analytical relevance with the substantive information about academic and professional paths and identity recomposition processes underway by higher education graduates.

### References

- Alves, Mariana G. (2007). *A inserção profissional de diplomados de ensino superior numa perspectiva educativa: o caso da faculdade de Ciências e Tecnologia*. Lisboa: Fundação Calouste Gulbenkian/ Fundação para a Ciência e Tecnologia.
- Célestin, J. -B. (2000). *As Novas Formas de Emprego Atípicas. Reflexões sobre o caso Francês*, 23, Ministério do Trabalho e da Solidariedade/ Direcção Geral do Emprego e Formação Profissional e Comissão Interministerial para o Emprego.
- Diana, V. & Marques, A. P. (2014), *Preparados para trabalhar?* Lisboa: Maior Empregabilidade.

- Evetts, J. (2012). Sociological analysis of the new profession-alism: knowledge and expertise in organizations, in T. Carvalho, R. Santiago and T. H. Caria (eds. ). *Grupos Profissionais, profissionalismo e sociedade do conhecimento* (13-27). Porto: Afrontamento.
- Evetts, J. (2010). Reconnecting Professional Occupations with Professional Organizations: risks and opportunities, in L. Svensson, & J. Evetts, (eds. ). *Sociology of Professions: continental and anglo-saxon traditions* (167-187). Goteborg: Bokforlaget Daidalos.
- Foucarde, B. (1992). A evolução das situações de emprego particulares de 1945 a 1990. *Travail et Emploi*, 52.
- Galland, O. (1984). Précarité et entrées dans la vie. *Revue française de Sociologie*, XXV, 49-66.
- Galland, O. (1996). L'entrée dans la vie adulte en France. Bilan et perspectives sociologiques. *Sociologie et Société*, Vol. XXVIII (1), 37-46.
- Galland, O. (1997). *La sociologie de la jeunesse*. Paris: Armand Colin.
- Gonçalves, C. M. , Menezes, I. , Martins, M. C. (2009). *Transição para o trabalho dos licenciados da Universidade do Porto (2006-2007)*. Porto: Universidade do Porto.
- Iannelli, C. ; Soro Bonmatí, A. (2003). Transition pathways in Italy and Spain: different patterns, similar vulnerability?. in W. Müller and M. Gangl (eds) *Transitions from Education to Work in Europe: The Integration of Youth into EU Labour Markets* (pp. 212-250). Oxford: Oxford University Press.
- Jobert, A. , Marry, C. and Tanguy, L. (1995). *Éducation et Travail en Grande-Bretagne, Allemagne et Italie*. Paris: Armand Colin.
- Kuhlmann, E. (2012). Professionalism matters: unpacking the knowledge-power nexus in healthcare governance. in T. Carvalho, R. Santiago e T. H. Caria (eds. ), *Grupos Profissionais, profissionalismo e sociedade do conhecimento* (151-162. ). Porto, Afrontamento.
- Machin, St. ; McNally, S. (2007). Tertiary Education Systems and Labour Market. *Tertiary Review*, OCDE.
- Marques, A. P. (2006). Entre o diploma e o emprego. A inserção profissional de jovens engenheiros. Porto: Afrontamento.
- Marques, A. P. (2007). *MeIntegra — Mercados e estratégias de inserção profissional. Licenciados versus empresas da Região Norte. Relatório final*. Universidade do Minho, URL: <http://hdl.handle.net/1822/8633>.
- Marques, A. P. (2010). 'Sacralização' do mercado de trabalho. Jovens diplomados sob o signo da precariedade. *Revista Configurações* 7, 65-89. Braga: CICS, Universidade do Minho.
- Marques, A. P. (2013). Empregabilidade e (novos) riscos pro-fissionais Brandão, in A. M. Marques & A. P. (Org. ) *Jovens, Trabalho e Cidadania: Que Sentidos?* (pp. 20-34), Ebook: CICS/ Univer-sidade do Minho ISBN 978-989-96335-1-3. [Online]. Available: [http://www.lasics.uminho.pt/ojs/index.php/cics\\_ebooks/issue/view/123](http://www.lasics.uminho.pt/ojs/index.php/cics_ebooks/issue/view/123).
- Marques, A. P. and Alves, M. G. (2010). *Inserção profissional de graduados em Portugal. (Re)configurações teóricas e empíricas*. V. N. Famalicão: Húmus.
- Muller, W. and Gangl, M. (eds) (2003). *Transitions from Education to Work in Europe: The Integration of Youth into EU Labour Markets*. Oxford: Oxford University Press.
- Schmid, G. (2000). *Transitional Labour Markets. A New European Employment Strategy*. In B. Marin, D. Meulders & J. Snower (eds. ). *Innovative Employment Initiatives*. Aldershot: Ashgate.
- Smithson, J. ; Lewis, S. and Guerreiro, M. das D. (1998). Percepções dos jovens sobre a insegurança no emprego e suas implicações no trabalho e na vida familiar. *Sociologia – Problemas e Práticas*, 27, pp. 97-133.
- Smyher, E. *et. al* (2001). *A Comparative Analysis of Transitions from Education to Work in Europe (CATEWE). Final Report*. Bruxelas: Comissão Europeia.

Teichler, U. (2007). *Careers of University Graduates. Views and Experiences in Comparative Perspectives*. London: Springer

Tomlison, M. (2009). *Higher Education and Graduate Employability*, VDM Publishing.

Tomlison, M. (2012). Graduate employability: A Review of Conceptual and Empirical Themes, *Higher Education Policy*, 25 (407-431).

Tomlison, M. (2013). *Education, Work and Identity. Themes and Perspectives*, Bloomsbury Academic.

---

## Formation of the Volunteering Institute in Russia as an Indicator of the Civil Society Development

**Isaeva Elena Alexandrovna**

Candidate of Law, associate professor,  
chair of family and social legislation at  
Demidov Yaroslavl State University  
elena2000@mail.ru

**Sokolov Alexander Vladimirovich**

Candidate of Political Science, associate professor,  
chair of Social and Political Theories at  
Demidov Yaroslavl State University  
alex8119@mail.ru

### Abstract

*In conditions of exacerbation of social problems, complexity of modern societies and the limited capacity of public authorities in their decision, attraction and activation of internal resources of the Russian society become urgent for social development. One of these resources is volunteering. Volunteer activities aimed primarily at helping needy segments of the population who can not help themselves due to objective circumstances and conditions (including elderly people, street children, people with disabilities or people who find themselves in the area of natural disasters and social cataclysms). The authors examine the legal conditions for the development of volunteering in Russia at federal and regional levels. They concluded that the potential for citizens' involvement in volunteer activities, at both the regional and federal levels, is higher than the participation itself. The development of the institutional environment for volunteering, including increasing the efficiency of public institutions of social development, are crucial for the actualization and realization of the hidden, untapped potential. Thus, to solve the problems of social development system requires more than just external, but, primarily, internal additional resources, methods of their searching, and technologies of its attraction. Volunteering as a social institution meets the objective challenges of our time and necessity of social and political modernization of regional society and Russian society as a whole.*

**Keywords:** volunteering, civil society, legislation, civil activity

### 1. Introduction

According to the scenario of modernization, Russia in the foreseeable future should become a state, providing social guarantees to citizens to the extent to which a society can not do it itself. It assumes accessibility of basic social services, that are provided free of charge for citizens; the redistribution of social expenditures in favor of the most vulnerable groups, while reducing services for prosperous groups.

At the same time, the possibility of state budget currently allow only soften the situation of the poorest in relation to which state has part of the liability measures; in relation to others - suggests preventive action in order to reduce unemployment and mitigate the effects of mass social risks. It seems that the solution to this problem is the gradual disposal of paternalism in the relationship model between the state and the citizen and the gradual transition to a more efficient mechanism of social adaptation and rehabilitation of socially weaker sections. The main mechanism of the formation and implementation of effective social policies, in our opinion, is to use the resources of civil society and social partnership of government, business and non-profit organizations.



Thus, in conditions of exacerbation of social problems, complexity of modern societies and the limited capacity of public authorities in their decision, attraction and activation of internal resources of the Russian society become urgent for social development. One of these resources is volunteering.

Volunteers, in terms of legislation of the Russian Federation [9], are citizens carrying out charitable activities in the form of unpaid labor in the interests of beneficiaries, including in the interests of a charitable organization without receiving monetary remuneration.

The term "volunteerism (voluntary) work" is often understood as a socially useful activity (individual or collective), gratuitously carried out on the basis of good will and free choice in favor of third parties or the public as a whole [6; p. 150]. Volunteer activities aimed primarily at helping needy segments of the population who can not help themselves due to objective circumstances and conditions (including elderly people, street children, people with disabilities or people who find themselves in the area of natural disasters and social cataclysms). Volunteering, in terms of active approach, can be defined as a system of public benefit, social and political activities, which includes subjects, objects, motivation, forms, methods and technologies.

Traditionally, volunteerism or volunteer activities are considered either from the sociology point of view - as a way of solving social problems [5], either in terms of pedagogy - as a method of education and socialization [1]. However, in our opinion, volunteering should be considered in a broader perspective - as an institution of civil society and an effective mechanism of civil participation. In the Universal Declaration on Volunteering [12] notes that volunteerism - is "the foundation of civil society, it brings to life the need for peace, freedom, security and justice, it is a way of preserving and strengthening human values, the rights and obligations of citizens, personal growth, through the human capacity realization. "

Thus, by understanding social institution (following the neo institutionalisms' theory) as a certain set of rules, formal or informal, and a mechanism to ensure their implementation [2], we can say, that volunteerism, in modern crisis conditions, becomes a social institution that is able to compensate "failures" of market economy, as well as, some of the inefficient functioning of state institutions.

## 2. Legal terms of volunteering

The Federal Law (Draft) № 300326-6 «About volunteerism (volunteer work)", submitted on June 21, 2013 to the State Duma of the Russian Federation, by Federation Council members A. A. Borisovym, Yu. L. Vorobevym, V. V. Ryazanskim, deputies of the State Duma V. V. Ivanov, M. A. Kozhevnikovoy, V. M. Kononov became widely discussed in the public sphere as a mechanism of formation the legal basis of volunteerism operation in Russia.

The subject of regulation of the bill is urgent nowadays issue requiring legal regulation. Despite the fact that the use of volunteer labor in Russia already has a long history [14, p. 330] and currently reviving culture of volunteerism is not alien to the large percentage of our citizens (for the last 2-3 years more or less than one-fourth of the Russians were engaged in voluntary and gratuitous public benefit activities [7, p. 13]), the regulatory framework on this issue is not sufficient. The definition of the legal nature of emerging relations within the application of the voluntary labor, the introduction of rules governing these relations, the formation of the conceptual apparatus is necessary. However, , it is important to find a "middle ground" in the process of developing a legal framework for the volunteer labor regulation, without creating bill, which may negatively affect the implementation of voluntary initiatives. Level of involvement in volunteering is a direct measure of self-expression and self-realization of citizens [8, p. 34]. It is also important not to go to opposite extremum - make the framework law contains no specific demanded practice of volunteer labor provisions.

Developers of the bill, in the explanatory note, rightly point out the lack of legal regulation of volunteering (voluntary) activity; indicate the need to improve the legislation in this area. At the same time bill is aimed at a very narrow aspect of the regulation of the volunteer work. Developers excluded from the subject of regulation (part 3, article. 1) activities designed to support NGOs and associations, corporate volunteering, actually bringing the subject of regulation of the bill only to volunteer labor, initiated and organized by the state authorities and local government. Thereby, regulation is aimed at "state volunteers. " In fact, the bill aims at statization of volunteering. Its adoption is aimed at not just volunteer labor regulation, but is dedicated at "facilitating the implementation of the functions of the organs of state power and local self-government"

---

(Part 2 of Article 3 of the Bill). Based on the text of the bill this direction is displayed as a primary. For "non-system" volunteers this bill does not bring nothing new in the sphere of legal regulation.

In addition, Part 2 of Art. 10 of the law draft contains an indication that in order "to attract volunteers for elimination of emergency situations on municipal, inter-municipal, regional, inter-regional and federal level, only organizer of the volunteer activity is entitled to do this. Normally, it is state authority or local governments and organizations dealing with emergencies in accordance with the legislation of the Russian Federation. Accordingly, citizens who wish to take part in extinguishing fires or flood relief does not have the right to help the victims without admission of the authority that seriously reduces the value of the bill in terms of development of volunteerism, and strengthening mutual traditions in Russia [11].

The bill, in contrast to its previous version, proposed by developers in January 2013 and caused a storm of public indignation, is not focused on creation of a unified closed registry of volunteers. The previous version of the bill in Article 14 includes provisions that all information contained on a national registry of volunteers are personal data and can not be transferred to third parties, except as stipulated by the legislation the Russian Federation. Based on the wording, only authorized body have access to the registry of volunteers. Thus, only state will be able to use the base, which a priori seriously impair the value of the registry. Every region of Russia is given the right to make decision on the establishment and maintenance of information resources, involving the registration of volunteers, and issuance of identification number.

Particularly every subject of the Russian Federation independently defines the need of conducting an information resource. The bill does not specify whether or not information resource will be public or private, will be used only by the authorities or by any persons in the region, this enables region to determine on their own the order of disclosure information about volunteers.

If any region of Russia for some financial or organizational reasons come to the conclusion that there is no possibility of forming its own portal, than it deprived volunteers of the right to "enter information on its implementation of the volunteer activity, location and number of hours and promotion, he had received additional training; the right to receive support and incentives" (claims 7 Part 3 of Art. 6 of the Draft Law). Realization of other rights, as stated in Part 3 of Art. Bill 6, without registration on the information portal can be questioned. In particular, obtaining letters of recommendation, work wear reimbursement for travel, possibility to obtain government awards. It can be assumed, that the registers will still be conducted in regions, but without the requirements of the federal law on data transparency of volunteers and the possibility of CO NGOs in the region to use information resource. Registers will turn out, as in the previous version of the bill "On volunteering," as just lists for official use, the list of "state volunteers" [4].

The closure of the voluntary initiatives within the closed system gives reason to believe that the bill is still aimed at the creation of the state volunteering system, including tools of budget savings (in support of the position we refer to the explanatory note, which states that "the state is interested in development of volunteering activities . . . and in terms of improving the economic effect of the volunteer work"

The bill includes a provision on the duty to maintain the confidentiality of information to which the volunteer has access in the course of volunteer activities (claims 4. H. 4 Art. 6). Well as the obligation not to interfere with realization of state and local officers duties. In fact, volunteer is becoming a person, that should work free of charge, strictly obey the instructions of the authorities, do not have the right to act without a special permit, and disclose what they saw / heard, and without opportunity to influence the decision-making process. In addition, a volunteer becomes a tool of implementation of the authorities' functions, which will, after signing the contract, is not taken into account, due to some limitations of their rights to terminate the contract unilaterally (claim 2 p. 3 art. 6 of the Draft Law). This violates Art. 37 of the Russian Constitution.

The experience of countries on conducting a clear definition of the status of volunteer demonstrates that despite the destination from labor legislation, volunteer is under the state protection to give certain guarantees and benefits. Important issue is about insurance for volunteers. For example, in Turkey insurance of volunteers is obligatory, in Albania volunteers supposed to be registered in the Employment Bureau. On the one hand, it seriously complicates the process of attracting volunteers for organizations, but if the event is financed by the State, the risks can be reduced. For example, in New Zealand and South Korea, the government provides insurance for volunteers if their work is associated with health risks. In Poland, volunteers have many benefits, such as accommodation expenses and subsistence expenses in the same amount as in the case of wage earners, compensation for other necessary expenses eligible for maintenance during illness and others. Moreover, this law introduces additional benefits for volunteers, delegated to work in other countries, such as medical insurance for foreign workers, insurance against injury, additional costs of travel and other.

An important aspect of the volunteer legal status is having the status of unemployed and receiving unemployment benefits. If an unemployed volunteer working as a volunteer, unemployment benefits should not be lost. For example, this issue has been resolved in the Czech Republic. In Macedonia, the Law on Volunteerism (2007) liberated themselves from taxation of the costs associated with volunteering, and made clear, that unemployed person does not lose the right to receive benefits if they are volunteers. This removed barriers for unemployed participation in volunteering, creating incentives for public volunteering for all individuals within a single legislative act. In Moldova the experience of volunteering counts as work experience and taken into account when calculating pensions.

Important legal issue in the regulation of volunteer work is related to its taxation. International practice shows good examples of this aspect of the regulation. For example, Polish law provides for tax exemption amount of compensation made by the volunteer organization of any organizational and legal form. In Lithuania compensation for volunteer work, is not considered as income, so is not taxed.

Based on foreign experience, basic content regulation on volunteering can perform the following:

- The definition of "volunteer" and "volunteering";
- The definition of "host organization";
- The content of the volunteer agreement and its conditions;
- The rights and obligations of the volunteer and the host organization in relation to each other;
- The provisions on liability, which apply to persons who violate the rules of volunteer activities;
- Taxes on the costs associated with the implementation of volunteer activities, such as travel costs, accommodation;
- Incentives for people to take part in volunteer activities, such as social benefits, contributions to the unemployment benefit;
- Terms of international volunteering, namely, voluntary activities of their citizens abroad and foreign citizens in the country.

Foreign experience demonstrates different models for the formation of legislation on volunteering: it may be provisions scattered in various regulations, and may be a separate comprehensive law on volunteering. This is the most commonly used model of regulation in Europe when all the provisions governing the volunteer activities, are combined into one single document. For example, the law of Macedonia provides a detailed description of the rights and responsibilities of volunteers and host organizations, terms of taxation applicable to reimbursement, volunteers' insurance conditions and determines responsibility for the offense.

A well-designed separate law can be an effective tool to promote volunteer activity, and in conjunction with national policies and strategies can contribute to the development of volunteer traditions in the country.

### **3. Development of volunteering (sociological dimension)**

Sociological studies of volunteering show a high degree of willingness of the population for volunteer activities. Thus, according to the WCIOM interrogation, 75% of young Russians are ready to engage in socially useful activities free of charge or for a nominal fee. 48% of young already have experience of such participation [13]. 53% of Russians worked voluntarily at least once for the benefit of society in the last five years.

Researchers from Center for Civil Society Studies and the nonprofit sector (HSE) at the Conference "Development Strategy of volunteering in Russia - 2020 Roadmap" noted that Russian organized volunteering covers only 3% of adult respondents (909 of those surveyed). However, it has a high potential: 37% of respondents (10 680 people) were included in finding solution for social problems in the community. Thus, the lag between the data from these two studies can be defined as the potential for the development of volunteering in Russia.

Leading motive of participation in volunteer activities is the desire to be helpful for those in need (58%). Much less, people are doing it in order to solve a problem (14%), because of the desire to share with others how to resolve it, to pay back good for good (12%). Some also noted that volunteers are becoming people for their own pleasure (17%), recreational and entertainment (12%), obtaining useful skills (5%), meeting new people (4%).

In 2013, three studies were carried out in order to find out regional characteristics of volunteering in the Yaroslavl region:

- Telephone survey by sample in 639 adult residents of the Yaroslavl region (statistically representative sample by gender and age, the standard error of the sample 3. 9);
- Survey of executives of 54 non-profit organizations of the Yaroslavl region.
- A survey of 52 federal and local authorities' representative

For each of this group unique questionnaire had been developed that allows taking into account the role of each entity in the implementation of a particular type of civic engagement.

Research has shown that volunteering in the Yaroslavl region developed at an average level - 4. 2 points (on a scale of 1 - 10 points). Authority, population and representatives of NGOs are almost equally in this issue (Table 1).

**Table 1.** What do you think about the degree to which volunteering is developed in the Yaroslavl region? (from 1 to 10)

	Average
Population	4,22
NGO representatives	4,22
Officials	4,24

A serious obstacle for the development of volunteering is the low level of activity of the population. According to a study conducted in the Yaroslavl region, more than half of the inhabitants exclude (38%) or rather exclude the possibility (17%) of gratuitous personal participation in any public associations, organizations, initiative groups. This figure is slightly higher than the nationwide identified in the study of "Public Opinion" Foundation in 2013 (49%) [10]. The main reasons for non-participation are lack of understanding of personal benefits from participation in public life, lack of time, lack of initiative groups to be joined.

20% of the surveyed allow, and 22% - rather admit for themselves gratuitously work in any public associations, organizations and initiative groups. Most of those who are willing to engage in active civil procedure (42% of the Yaroslavl region) are 18-29 years old, as well as those of middle age - 30-49 years, mostly with higher education; every two respondents from these socio-demographic categories indicated that prevent or rather permit gratuitous private participation in any public associations, organizations, initiative groups. Civic duty or opportunity to contribute to the solution of socially significant problems are the main mentioned factors of participation. Apparently, this is the main component we need to emphasis in the promotion of volunteering. Especially when such work is necessary in order to bring the importance and benefits of volunteering for all.

For 81% of the surveyed executives the work of NGOs is inconceivable without the labor of volunteers. Most often, such need arises while organising NGO activities (78%). A number of non-governmental organizations ensure the information support of NGO activities (33%) on a voluntary basis. Number of volunteers in the organization strongly depends on the scale of activities. Thus, the number of volunteers in the surveyed organizations ranged from 0 to 350, and the number of hours per month when volunteer is involved in the organization - from 0 to 200.

Leaders of non-profit organizations indicate that most prone categories for volunteering are students (74%), pensioners (50%), and pupils (37%). Main challenges of working with volunteers are motivation, lack of time and lack of staff member responsible for them (28%), lack of practice to attract volunteers (26%), and unsystematic nature of working with volunteers (26%). According to surveyed executives of NGOs, greater coverage of the non-profit and public organizations in the media (48%), more active government support of the volunteer movement (44%), the positive image of non-profit organizations and volunteering in the public consciousness (40%) are the main catalysts for the development of volunteering.

**Table 2.** What could encourage greater involvement of volunteers in non-profit and community organizations? (NGO representatives)

Answer	%
Increased coverage of non-profit and public organizations activities in the media	48,1%
More active government support of the volunteer movement	44,4%
Creating a positive image of non-governmental organizations, as well as volunteering in the public consciousness	38,9%
More active encouragement of volunteers	35,2%
More active work of non-profit and community organizations with a society	22,2%

In this regard, a large-scale information campaign on a wider coverage of the work of NGOs, as well as a positive image of public organizations and volunteering, aimed at addressing the lack of awareness among the population, could contribute to the rapid development of NGOs and volunteering. Non-governmental organizations must be ready to talk openly about their work. Therefore, the objectives of the organization are not just to create informational occasion, but make it interesting for the audience and the media. Creative and modern approach to outreach is needed today, in order to attract someone as volunteers in the future.

Most of the surveyed executives of NGOs say that they do not form relationship with volunteers (80%). As a key motivational stimulus NGO's representatives use gratitude and certificates (52%), obtaining new skills (46%), recommendations / positive characteristics of employment (41%).

85% of authorities are aware about the necessity to develop the volunteer movement. Among the mechanisms that need to be developed, the experts proposed the following:

- Adoption of a law on volunteering;
- Informational support of projects;
- Promotion of volunteer work in educational institutions;
- Network development for volunteer centers, united by a common mission and activities;
- Improving professional competence of specialists working in the field of volunteer resources, non-profit organizations, business organizations, educational institutions, community groups, through the development and implementation of training programs in order to increase efficiency of the volunteer organizations;
- Multiplication of funding for youth involvement in volunteer activities (visual materials, promotion, education);
- The creation of a favorable image of volunteers, introduction of non-financial incentives of volunteers (training seminars, etc. ).

#### 4. Conclusions

Based on the above it can be concluded that conceptual approach is needed to ensure wide development of the institution of volunteering in Russia, and filling gaps in legislation with respect of volunteers in the broadest sense of the term.

The value of developing a culture of volunteerism for the state is difficult to overestimate. In addition, it is an integral part of civil society, contributing to its development and prosperity. The value of volunteering can be measured in terms of social and economic capital. In particular, competent normative regulation of this institution can contribute to the support of the priorities, selected by the government, the achievement of certain social goals through the resource of volunteers. Within this block, norms of citizen engagement in volunteer activities at the level of legal regulation may be generated within the priority areas for the state. For example, some areas in which, according to the State, volunteers are especially in need (social services, health care, and others. ), can be identified as well as mechanisms for their engaging and stimulating.

The value of volunteer resources, in the implementation of large state mechanism for responding to emergencies, is huge. Mechanism of regulation of voluntary activity should allow the state, in a critical situation, using incentives, direct volunteer streams in the desired direction (firefighting, elimination of consequences of floods, etc. ).

In the development of legislation on volunteering, it is necessary to consider encouraging norms. For example, financial and material assistance to the volunteers involved in firefighting and rescue operations, as well as loans and benefits from employers, workers and universities who participated in the liquidation of emergency situations. Compensation for volunteering can serve as exemption from military service.

In a situation of rising unemployment, low mobility and reorientation of persons who lost their jobs or do not have work experience, well formed Institute of Volunteering can play a positive role. For example, the program to involve the unemployed in volunteer programs will lead to the acquisition of new skills as part of a community service; the introduction of evaluation certificates, which can serve as an official confirmation of passing the professional internship, will contribute to the unemployed to find work.

As an incentive, credit system for volunteers can be used. For example, in 2005 the Department of Taxation in New Zealand amended the "Principles of lending students" so that students wishing to take out a loan were able to work in the specified charitable organizations as volunteers or for a nominal fee, and thus be eligible for a two-year exemption from payment of interest.

It is necessary to determine the precise legal status of volunteers, and make a distinction between employee and volunteer in the national legislation in order to develop the institute of volunteerism. Disregard of the legislator to the delimitation of legal status, puts organization, which uses volunteer labor, under the threat of accountability for non-compliance with labor laws. Russian labor legislation does not contain the feasibility of using labor free of charge, which complicates the understanding of the structure by controlling bodies.

Initiatives, related to the development of volunteerism in Russia, should take into account national characteristics and include mechanisms that can positively affect the elimination of the bad image of volunteering in Russia - "compulsory" volunteering in support of government priorities (work not on heart call, but in the direction of the state by using enforcement mechanisms). Mechanism for creation a culture of volunteerism are important. We have to enter volunteering into the system of education, in order to involve students in volunteer projects. For example, schools can enter a "day of volunteering", which would take place for all age groups. Each class can spend the day, doing appropriate for their particular age.

In summary, we can conclude that the potential for citizens' involvement in volunteer activities, at both the regional and federal levels, is higher than the participation itself. The development of the institutional environment for volunteering, including increasing the efficiency of public institutions of social development, are crucial for the actualization and realization of the hidden, untapped potential. Thus, to solve the problems of social development system requires more than just external, but, primarily, internal additional resources, methods of their searching, and technologies of its attraction. Volunteering as a social institution meets the objective challenges of our time and necessity of social and political modernization of regional society and Russian society as a whole.

\* The study was sponsored by the Ministry of Education and Science of the Russian Federation under the basic portion of the state scientific research of Demidov Yaroslavl State university, project number 1127 "Legal and socio-political aspects of civic engagement in modern Russia"

## References

1. Arapov M. O. 2013. *Interaction of cultural institutions activities and volunteer movement on the formation of social qualities of youth: Abstract. Thesis... Phd. – Moscow.*
2. Auzan A. A. 2010. *Institutional Economics. New Institutional Economic theory.* Moscow: INFRA-M.
3. Holina O. I. 2011. *Volunteering as a social phenomenon of modern Russian society.* - Theory and practice of social development. № 8.

- 
4. Isaeva E. A. Nationalization of the of volunteering institute in Russia: Analysis of the bill "On volunteering" Power. 2013. № 10.
  5. Kudrinskaya L. A. 2006. *Volunteer work: the experience of theoretical reconstruction*: abstract. Thesis . . . Phd. Sociological science, Moscow.
  6. Loginova N. V. 2012 *Volunteering as social phenomenon: the experience of presentation of the conceptual vocabulary*. Political Linguistics № (41).
  7. Mersyanova I. V. The involvement of the population in the informal practices of civil society and NGO activities. Moscow, 2011. P. 98; Mersyanova I. V. Differentiation of the Russian regions in the context of prerequisites for the formation of civil society // Power. - 2008. №8.
  8. Mordasova T. A. The social model of charity as a factor of civil society institutions development // Caspian region: politics, economy, culture. - 2009. №4.
  9. On Charity and Charitable Organizations: Federal Law of 11 August 1995 N 135-FZ (rev. May 5, 2014) // Legal System GARANT: <http://base.garant.ru/104232/#ixzz3GZ43GD6l> (tested 10. 11. 2014).
  10. *Resource of the volunteer movement of avant-garde groups for Russia's modernization*. Report FOM, July 2012 Access: [http://soc.fom.ru/uploads/files/dobrovolchestvo/Otchet\\_dobrovolchestvo.pdf](http://soc.fom.ru/uploads/files/dobrovolchestvo/Otchet_dobrovolchestvo.pdf) (tested 10. 11. 2014).
  11. Sokolov A. V. , Solovyova A. V. Network civil movements (for example, "Musora. Bolshe. Net. ") // Power. 2012. №12.
  12. *The Universal Declaration on Volunteering*. Access: [http://www.kdobru.ru/materials/Всеобщая\\_Declaration\\_Dobrovolchestva.pdf](http://www.kdobru.ru/materials/Всеобщая_Declaration_Dobrovolchestva.pdf) (tested 10. 14. 2014).
  13. Volunteering in Russia: the potential of youth participation. Access: <http://wciom.ru/index.php?id=459&uid=111713/> (tested 11. 10. 2014).
  14. Voronova E. A. Volunteering as a form philanthropy in contemporary Russia // Vestnik St. Petersburg University. Series 12. Psychology. Sociology. Pedagogy. 2011. №1.

---

## Financial Inclusion and Turkey

Nuray Terzi

Marmara University,

Department of Economics, Turkey

[nurayterzi@marmara.edu.tr](mailto:nurayterzi@marmara.edu.tr)

### Abstract

*Financial inclusion is the most recent item to be added explicitly to the social inclusion agenda and promotes the need for access among all segments of society to a range of financial services at affordable cost. Small and medium-sized enterprises (SMEs) have played a crucial role in boosting the economy, increasing employment, and creating industries. However, many SMEs in developing economies lack access to loans and lines of credit. With global financial crisis, developing economies have started to promote financial inclusion, especially greater access to financial services for SMEs, as part of their overall strategies for economic and financial development. In this perspective, this study provides a survey of progress on financial inclusion in Turkey on the basis of SMEs.*

**Keywords:** Financial Inclusion, Financial Stability, SMEs Financial Inclusion.

### 1. Introduction

In recent years, financial inclusion has been a global agenda. Many countries are employing financial inclusion as an important part of their strategies to achieve inclusive growth. In general, inclusive finance is crucial to sustain economic and social development. It is also expected to lead to greater financial stability and growth.

In terms of three areas, more effort is needed to address gaps in the understanding of financial inclusion. First is the quality of regulatory policies. Ineffective policy measures, too much regulation, or the lack of internal synergies to implement financial inclusion are familiar cautionary tales in all countries. Second, it is also important to have a positive enabling environment for promoting financial inclusion. This means that policies that support financial inclusion have to be closely connected with the pursuit of macroeconomic stability. Financial access is impossible without increasing the capacity of individuals and firms to access higher income levels. Finally, greater financial inclusion is only possible if undertaken responsibly. In as much as inclusion is about increasing the capability to use financial services, it is crucial that those who are directly affected are financially literate and capable (Rillo, 2014).

SMEs have played a crucial role in boosting the economy, increasing employment, and creating industries. However, around 200 million formal and informal micro, small and medium enterprises in developing economies lack access to loans and lines of credit. An estimated about 55 - 68 % of formal SMEs lack adequate financing. SMEs are also held back by inefficient or costly business-to-business payments options; a lack of appropriate risk management products, such as insurance, and a shortage of growth capital. Moreover, women owned SMEs have consistently lower access to finance worldwide (CGAP and IFC, 2013). To increase share of lending to SMEs can help financial stability, mainly by reducing non-performing loans and the probability of default by financial institutions. Moreover, policy measures to increase financial inclusion by SMEs will have the side-benefit of contributing to financial stability.

From this perspective, this study contributes to the literature on this subject by examining the financial inclusion in Turkey on the basis of SMEs. In order to achieve this, the paper is organized as follows. Section 2 gives an overview financial inclusion. Section 3 examines financial inclusion and SMEs. Section 4 analyzes financial inclusion in SMEs in Turkey. Last section provides a conclusion.

### 2. An Overview of Financial Inclusion



Financial inclusion is most commonly thought of in terms of access to credit from a formal financial institution, but the concept has more dimensions. Formal accounts include both loans and deposits, and can be considered from the point of view of their frequency of use, mode of access, and the purposes of the accounts. There may also be alternatives to formal accounts, such as mobile money via mobile telephones. The main other financial service besides banking is insurance, especially for health and agriculture (Demirguc-Kunt and Klapper 2012).

Financial inclusion aims at drawing the “unbanked” population into the formal financial system so that they have the opportunity to access financial services ranging from savings, payments, and transfers to credit and insurance (Hannig and Jansen 2010).

The Reserve Bank of India has also defined financial inclusion as the process of ensuring access to appropriate financial products and services needed by all sections of the society in general and vulnerable groups such as weaker sections and low income groups in particular at an affordable cost in a fair and transparent manner by mainstream institutional players (Joshi 2014). Financial inclusion also encompasses the broadening of financial services to those people who do not have access, the deepening of financial services for people who have minimal access (Rajan 2014).

The original Financial Inclusion Action Plan (FIAP) was endorsed by leaders at the Seoul Summit in 2010. Universal financial inclusion requires bringing the 2.5 billion people (or about half the working age population) currently excluded, into the formal financial system. The credit gap for formal and informal micro, small and medium enterprises in emerging and developing economies estimated at US\$2 trillion. Financial inclusion helps build domestic savings, bolster household, domestic and financial sector resilience, and stimulate business and entrepreneurial activity. The cumulative effect of widespread exclusion is increasing inequality, and slower growth and development. The Global Partnership for Financial Inclusion (GPII) is an inclusive partnership mechanism to take forward the G20’s work on financial inclusion. The GPII produces coordinated analysis and policy recommendations to enhance financial inclusion; facilitates efficient and effective coordination to support various on-going financial inclusion efforts; monitors progress over time and against agreed objectives; and ensures continuity on financial inclusion in global discussions (GPII, 2014).

In short, financial inclusion addresses: (i) who has access; (ii) how easy it is to access (cost, distance); and (iii) what types of services are accessible. At the Millennium Development Goals Summit of 2010 these elements were combined to define financial inclusion as “universal access, at a reasonable cost, to a range of financial services for everyone needing them, provided by a diversity of sound and sustainable institutions” (Maxima 2010).

Financial inclusion might also affect financial stability both positive and negative. According to Khan (2011) there are three main ways in which greater financial inclusion can contribute positively to financial stability. First, greater diversification of bank assets as a result of increased lending to smaller firms could reduce the overall riskiness of a bank’s loan portfolio. This would both reduce the relative size of any single borrower in the overall portfolio and reduce its volatility. This would reduce the “inter-connectedness” risks of the financial system. Second, increasing the number of small savers would increase both the size and stability of the deposit base, reducing banks’ dependence on “non-core” financing, which tends to be more volatile during a crisis. This corresponds to a reduction of procyclicality risk. Third, greater financial inclusion could also contribute to a better transmission of monetary policy, also contributing to greater financial stability.

Demirguc-Kunt and Klapper (2012) found that a 10% increase in the share of people that have access to bank deposits can reduce the deposit growth drops (or deposit withdrawal rates) by 3–8 percentage points, which supports the case that financial inclusion is positive for financial stability. Hannig and Jansen (2010) argue that low-income groups are relatively immune to economic cycles, so that including them in the financial sector will tend to raise the stability of the deposit and loan bases. They suggest that financial institutions catering to the lower end tend to weather macro-crises well and help sustain local economic activity. Prasad (2010) also observes that lack of adequate access to credit for small and medium-size enterprises and small-scale entrepreneurs has adverse effects on overall employment growth since these enterprises tend to be much more labor intensive in their operations.

Khan (2011) also suggested that increased financial inclusion could contribute negatively to financial stability. The most obvious example is if an attempt to expand the pool of borrowers results in a reduction in lending standards. This was a major contributor to the severity of the “sub-prime” crisis in the United States. Second, banks could increase their reputational risk if they outsource various functions such as credit assessment in order to reach smaller borrowers. Finally,

if microfinance institutions are not properly regulated, an increase in lending by that group could dilute the overall effectiveness of regulation in the economy and increase financial system risks.

As a result, the literature suggests that greater financial inclusion could be either positive or negative for financial stability. Positive effects include the diversification of bank assets by reducing their riskiness; increased stability of their deposit base, reducing liquidity risks; and improved transmission of monetary policy. Negative effects include the erosion of credit standards bank reputational risk, and inadequate regulation of microfinance institutions.

### 3. Financial Inclusion and SMEs

A key lesson of the 2007–2009 global financial crisis was the importance of containing systemic financial risk and maintaining financial stability. At the same time, developing economies are seeking to promote financial inclusion, namely greater access to financial services for low-income households and small firms, as part of their overall strategies for economic and financial development (Morgan and Pontines, 2014).

There is a growing body of evidence on the impact of access to financial services at the microeconomic, local economic and macroeconomic levels. Theory presents that an appropriate range of quality financial services helps households smooth consumption, mitigate and manage risks, build assets, and create the peace of mind needed to make effective decisions about the future. Especially, small and medium enterprise owners can use credit or savings to invest in productive assets, insurance to manage risks, and payments services to make transactions more efficient and safe (Table 1).

At the macroeconomic level, the literature shows that financial inclusion is correlated with economic growth and development. An inclusive financial system facilitates inclusive growth by strengthening financial systems, allocating resources more efficiently, and creating opportunities for all (CGAP and IFC, 2013).

Although there has been growing recognition of the importance of SMEs for job creation and economic development, SMEs themselves report lack of access to finance to be one of the greatest barriers to their growth. Half of SMEs in emerging markets are credit constrained. Seventy percent of micro, small, and medium enterprises (MSMEs) have no access to external finance, and another 15 percent are under-financed (IFC, 2013). All this adds up to an estimated credit gap of US\$2 trillion.

Policy reforms vary from country to country such as loan guarantees, government funding, regulations requiring SME finance and infrastructure for SME finance. Studies showed that increased financial inclusion has affected SMEs positively. Morgan and Pontines (2014) found some evidence that an increased share of lending to SME aids financial stability, mainly by reducing non-performing loans and the probability of default by financial institutions. This suggests that policy measures to increase financial inclusion, at least by SMEs, would have the side-benefit of contributing to financial stability as well. In addition, reforms in China allowed the rural banking system, once dominated by state-owned banks, to diversify and enabled new market players (such as agro-related banks, village township banks, and postal savings banks) to expand financial services to rural areas. The reforms also resulted in the creation of some innovative products and services for financial inclusion such as the SME Board and ChiNext (Growth Enterprise Board), two innovative funding markets for small and medium-sized enterprises (Rillo, 2014).

### 4. SMEs Financial Inclusion and Turkey

Turkey is the 17th largest economy in the world in terms of GDP, a member of G20, OECD and a candidate for European Union membership. Economic growth in Turkey was briefly interrupted by the 2009 global recession due to the drop in international demand and structural problems with international competitiveness. Turkey recovered quickly but GDP growth slowed in 2014 as a result of weak domestic demand and spill-overs from the European debt crises. Due to domestic political events, Turkey's financial markets and lira have been under pressure and private and public consumption has decreased in real terms.

SMEs in Turkey are most important part of business economy. They provide most jobs, account for 99.9 % of all businesses and produce 53% of the value added in the whole economy. Especially, micro-SMEs provide almost half (46 %) of the

employment in Turkey and create about percent of 20 % of total value added (Table 2). For this, the development of SMEs financial inclusion is the center of financial policy in Turkey.

SMEs financial inclusion will be examined by accessing to financial services. Access to financial services is classified into the three sides: the supply side, the demand side and policy perspectives. Supply side includes the distribution of total credits, credits of SMEs and number of banks offering SME credits. Demand side constitutes of usage of external financing by SMEs, significance of factors limiting access to financing and most pressing problems for SMEs. Policy perspective comprises the programs exist to support micro, small and medium-sized enterprises.

#### *Supply Side*

Graph 1 shows the distribution of credits in Turkey. According to Graph 1, commercial and corporate credits constitute of the biggest part of the credits. It is 44% of total credits. Consumer credits and credit cards are 29 % of total credit. The share of SMEs credits is 27 % of total credits.

The SMEs credits have increased since 2009. Micro, small and medium sized SMEs credits increased more than three times between 2009 and 2014. However, there is a slower in increase in SMEs credits in recent years (Graph 2). An OECD report (2012) identified gaps in microfinance. However, domestic bank lending to the private sector has increased significantly in recent years: around 80 % of loans to SMEs come from commercial banks. The government encourages public and private banks to increase lending to SMEs, so banks are very inclined to offer loans. Only outside the major cities does access to finance remain a challenge (EC, 2014).

In Turkey, 21 banks provide SME loans. Most of them is privately-owned deposit banks and foreign banks founded in Turkey. A few is state-owned and privately owned development and investment bank. Others are state-owned deposit banks and privately-owned participation banks (Table 3). In addition, 74 specialized leasing companies offer leasing, and 76 specialized factoring companies provide factoring services. 2 MFIs provide microcredit to low income female entrepreneurs. 2 public loan funds provide loan-interest loans to SMEs. SMEs have access to a variety of financing products: loans (such as cash loans, discount and purchase loans, spot loans, day loans), overdrafts, credit cards, non-cash loans (letter of credit, letter of guarantee), factoring and leasing services (Microfinance Center, 2014).

#### *Demand Side*

71% of SMEs have used debt financing within the last 6 months. Bank loans are the most common source of external financing, used by 58% of SMEs. Trade credit is the second most popular instrument, used by 47% of SMEs. Overdraft facilities, and leasing/factoring facilities, are less frequently used in Turkey (Graph 3).

According to EU SAFE research (2013), over 40% of SMEs in Turkey do not see any obstacles to obtain financing. Low affordability, and high interest rates, on credit are perceived the biggest concern in using external funding affecting more SMEs in 2013 compared to 2 years previously. High guarantee requirements are the second most limiting factor in accessing SME credit, although experienced by fewer SMEs in 2013 than in 2011. SME credit is usually indexed to foreign currencies so currency fluctuations affect credit cost. Long-term loans (over 10 years) are rarely available, limiting larger investments in company development (Graph 4).

Additionally, access to finance is not the biggest problem facing Turkish SMEs. 16% of them consider lack or limited access to be the biggest constraint, making it fourth in the list of pressing concerns. The most pressing problems for Turkish SMEs are difficulties in finding customers, skilled staff and experienced managers, as well as high costs of the production and labour (Graph 5).

#### *Policy perspectives*

In Turkey, a number of programs exist to support micro, small and medium-sized enterprises. There are four separate government investment operations that provide funding for SMEs: Angel Investment Scheme, G 43 Anatolian Venture Capital Fund, KOBİ Venture Capital Investment Trust, and Istanbul Venture Capital Initiative.

The first, the "Angel Investment Scheme," program is designed to provide financing and technical assistance for small, start-up SMEs that lack adequate collateral and also need help with the essentials of good business practices. The Turkish Treasury offers tax incentives for angel investors (75 percent of the amount invested can be deducted from taxes, and up to 100 percent in the case of SMEs that are involved in government-supported technical projects). Angel investors can own

up to 50 percent of the shares in the SME, with the shares held for at least two years, and are also expected to provide technical assistance to their SMEs. The minimum amount to be invested is just under US\$10,000, while the maximum is just over US\$475,000. According to Ertürk and Öcal (2014) during the first year of the program, 182 business angels have been licensed and several networks of angel investors are also being added to the program. This rapid start-up can be attributed to efforts to mobilize supporters, in both the public and private sectors, with the enabling legislation also being prepared with similar support. During just the first year of the program, there have been five angel investments for slightly under US\$850,000 and for an average of about US\$170,000, with others currently being assessed for support.

The second program is a venture capital fund for the 43 provinces of Anatolia, funded primarily by EU's Instrument for Pre-Accession Assistance (IPA), with the collaboration of two Turkish government agencies, the Ministry of Science, Industry, and Technology as the operating structure, and the Small and Medium Enterprises Development Organization (KOSGEB) as the recipient of assistance. The European Investment Fund (EIF) is the trustee administrator for the EIF-IPA Commitment. An initial agreement was signed in August 2011, with a further agreement in December, and operations starting at the end of 2013. The fund manager and the Istanbul Venture Capital Initiative are also investors in the fund. Although research for investments in SMEs has started, no funds have as yet been disbursed (KOSGEB, 2014). G-43 Anatolian Venture Capital Fund targets SMEs especially in developing regions of Turkey.

The third program, the KOBİ Venture Capital Investment Trust, began operations in 2006 with three main partners, including both the public and private sectors (KOSGEB, TOBB, and Halkbank), with the purpose of investing in local SMEs that show high potential for innovation. In providing both financial and managerial support to qualifying SMEs, KOBİ's investments are limited to 49 percent of the SME's capital and can range from US\$250,000 up to US\$1 million, depending mainly on the wide range of business types supported. Potential investments are based on a detailed list of specific criteria and also include a position on the SME's managerial board. Therefore, after the investment is made, KOBİ remains highly involved: preparing and implementing business plans, carefully measuring both targets and accomplishments and, at times, even in day-to-day operations. Given these high criteria, investing in only 10 of 2,124 applicants, it is not surprising that these 10 businesses are all highly successful, with sales and profits increasing every year in virtually every case, and their excellent growth often requiring substantial additional investments (Öktem, 2014).

The fourth Turkish program, the Istanbul Venture Capital Initiative (İVCİ), established in 2007, is also partly funded by the EU through its European Investment Fund, along with the National Bank of Greece Group, Garanti Bank, and various Turkish government entities, including KOSGEB, the Technology Development Foundation of Turkey and the Development Bank of Turkey. The İVCİ invests for a long time horizon, six to 10 years, and in private equity and venture capital funds, as well as directly, along with other funds, in SMEs. As of the end of March 2014, it had invested over US\$95 million, with commitments of over US\$195 million. As a "fund of funds," İVCİ believes that its main contribution has been to stimulate the development of various other funds by demonstrating what can be done directly, as well as by investing in other funds. Fourteen SMEs had benefited directly from İVCİ investments as of the end of March 2014, with 25 percent of its investments ultimately going to SMEs (KOSGEB, 2014).

## 5. Conclusion

Financial inclusive growth has recently become one of the world's most important policy goals, and economists have given attention to SMEs financial inclusion. SMEs play a crucial role in boosting the economy, increasing employment, and creating industries. Therefore, this study analyzed financial inclusion in Turkey on the basis of SMEs in terms of supply side, demand side and policy perspectives.

On the supply side, SMEs credits have increased since 2009. As a result of this, there is a broad SME credit usage with many firms taking bank loans. Enterprise credit available from the majority of deposit banks both state-owned and foreign bank. On the demand side, bank loans are the most common source of external financing and trade credit is the second most popular instrument. Others, such as overdraft facilities, and leasing/factoring facilities, are less frequently used in Turkey. Low affordability, and high interest rates, on credit are perceived the biggest concern in using external funding affecting more SMEs. High guarantee requirements are the second most limiting factor in accessing SME credit. Additionally, access to finance is not the biggest problem facing Turkish SMEs. The most pressing problems for Turkish SMEs are difficulties in finding customers, skilled staff and experienced managers, as well as high costs of the production

and labor. In terms of policy perspectives, government focuses on improving financial inclusion of SMEs with Angel Investment Scheme, G- 43 Anatolian Venture Capital Fund, KOBİ Venture Capital Investment Trust, and Istanbul Venture Capital Initiative programs. These programs have started to give their positive results. In summary, SMEs will be continuing the most important part of business economy in Turkey. They provide most jobs, account for most of all businesses and produce more than half of the value added in the whole economy. Therefore, policy measures to increase SMEs financial inclusion will contribute to financial stability as well as economic growth in Turkey.

## References

- BRSA (2014). Turk Banking Sector Main Indicators, September.
- CGAP and IFC (2013). Financial Inclusion Targets and Goals: Landscape and GPFİ View, October, <http://www.gpfi.org/sites/default/files/documents/Financial%20Inclusion%20Targets%20and%20Goals.pdf>.
- Demircu-Kunt, A., and L. Klapper. (2012). Measuring Financial Inclusion: The Global Findex Database. Development Research Group Policy Research Working Paper No. 6025. Washington, DC : World Bank.
- EC (2014). 2014 SBA Fact Sheet: Turkey, European Commission.
- Ertürk H. and Öcal, K. (2014). "Turkey: Angel Investment Scheme" *Enhancing SME Access to Finance-Case Studies*, IFC.
- GPFİ (2014). 2014 Financial Inclusion Action Plan. GPFİ.
- Hannig, A., and S. Jansen. (2010). Financial Inclusion and Financial Stability: Current Policy Issues. *ADBI Working Paper 259*. Tokyo: Asian Development Bank Institute. Available: <http://www.adbi.org/workingpaper/2010/12/21/4272.financial.inclusion.stability.policy.issue>.
- IFC/McKinsey & Company (2013). Two Trillion and Counting: Assessing the Credit Gap for Formal and Informal SMEs.
- Joshi, D. P. (2014). Strategy Adopted for Financial Inclusion. Address at a workshop organized by the Government of Madhya Pradesh. New Delhi. 24 January.
- Khan, H. R. (2011). Financial Inclusion and Financial Stability: Are They Two Sides of the Same Coin? Address by Shri H. R. Khan, Deputy Governor of the Reserve Bank of India, at BANCON 2011, organized by the Indian Bankers Association and Indian Overseas Bank, Chennai, India, 4 November.
- KOSGEB (2014). Turkey : G43 Anatolian Venture Capital Fund, *Enhancing SME Access to Finance-Case Studies*, IFC.
- KOSGEB (2014) Turkey: Istanbul Venture Capital Initiative, *Enhancing SME Access to Finance-Case Studies*, IFC.
- Maxima, P. (2010). Financial Inclusion: A Path to the Millennium Goals. Speech by the UN Secretary-General's Special Advocate for Inclusive Finance for Development at a side event during the MDG Summit 2010. <http://www.koninklijkhuis.nl/globale-paginas/taalrubrieken/english/speeches/speeches-archive/2010/september/speech-by-princess-maxima-un-secretary-general%E2%80%99sspecial-advocate-for-inclusive-finance-for-development/>
- Morgan, Peter J. and Victor Pontines (2014). Financial Stability and Financial Inclusion, *Asian Development Bank Institute Working Paper Series*, No. 488, p. 1-16.
- OECD (2012). SME Policy Index: Western Balkans and Turkey 2012: Progress in the Implementation of the Small Business Act for Europe, *OECD Publishing*, p 249-250. <http://dx.doi.org/10.1787/9789264178861-en>
- Öktem, O. (2014). Turkey: Venture Capital Investments, *Enhancing SME Access to Finance-Case Studies*, IFC.
- Prasad, E. (2010). Financial Sector Regulation and Reforms in Emerging Markets: An Overview. *NBER Working Paper 16428*. Cambridge, MA: National Bureau of Economic Research.
- Rajan, R. (2014). Financial Inclusion—Technology, Institutions, and Policies. Keynote Address at the National Association of Software and Services Companies India Leadership Forum. Mumbai. 12 February.

Rillo, D. Aladdin (2014). An Overview of Financial Inclusion in Asia, *Financial Inclusion in Asia: Country Survey*, Asian Development Bank Institute.

**Table 1. The Use of Financial Services**

	Individuals/Micro Enterprises	Small and Medium Enterprises
<b>Credit</b>	* Consumption smoothing *Investment in human development (health, education, etc. )	*Financing for working capital and for investment *From financial institutions or through supply chain
<b>Savings</b>	*Cushion in case of shocks * Low-risk source of self-financing	*Savings (retained earnings) as primary source of financing
<b>Insurance</b>	Risk-management tool for managing shocks	*Lower risks of business activity
<b>Payments</b>	Safe and low-cost alternatives to informal mechanisms and cash	*For efficient, low cost, and safe transactions

Source: CGAP and IFC (2013) , Financial Inclusion Targets and Goals: Landscape and GPFi View, October, <http://www.gpfi.org/sites/default/files/documents/Financial%20Inclusion%20Targets%20and%20Goal.pdf>

**Table 2. SMEs in Turkey**

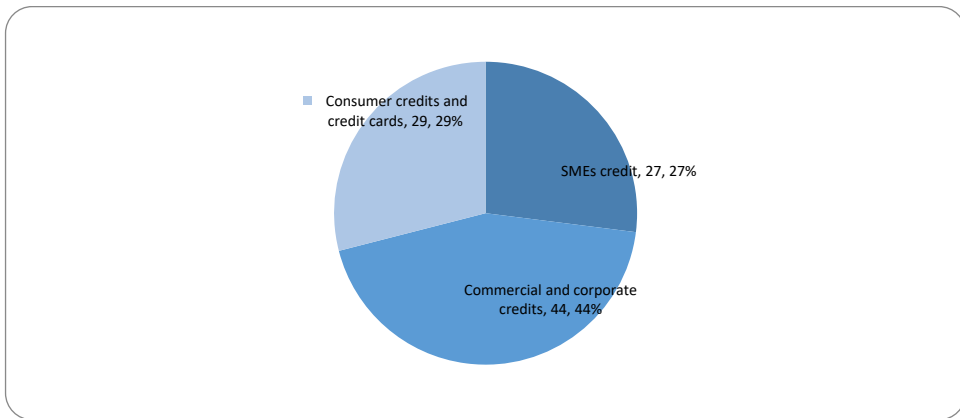
	Number of enterprises		Number of employees		Value added	
	Number	Proportion	Number	Proportion	Billion €	Proportion
<b>Micro</b>	2. 326. 148	97. 3 %	5. 019. 845	46. 5%	29	19. 6%
<b>Small</b>	42. 641	1. 8 %	1. 327077	12. 3%	19	12. 7%
<b>Medium Sized</b>	18. 132	0. 8%	1. 830. 242	16. 9%	30	20. 6%
<b>SMEs</b>	2. 386. 921	99. 9%	8. 177. 164	75. 7%	78	52. 9%
<b>Large</b>	3. 506	0. 1%	2. 626. 790	24. 3%	69	47. 1%
<b>Total</b>	2. 390. 427	100. 0%	10. 803. 954	100. 0%	147	100. 0%

Source: Turkish Statistical Institute.

**Table 3. Number of Banks Offering SME Credit, March 2014**

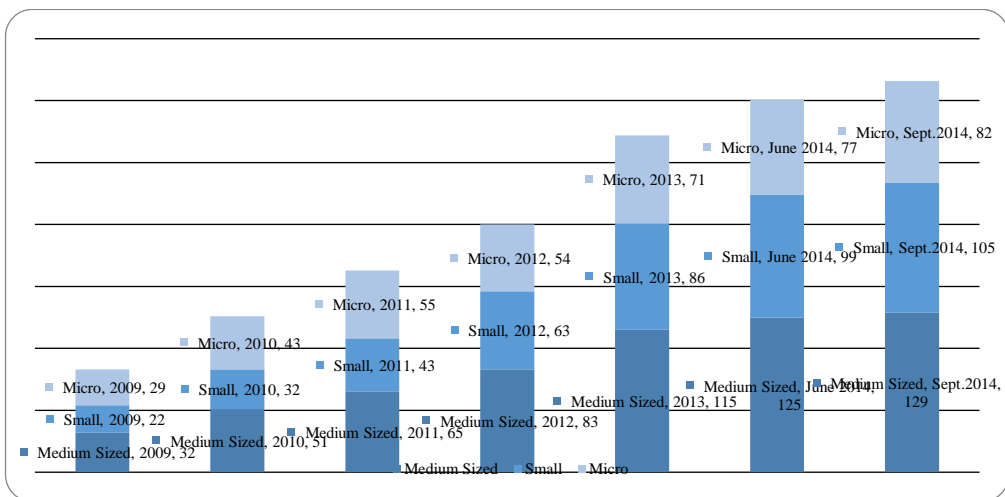
Privately –owned deposit banks	8
Foreign banks founded in Turkey	6
State-owned deposit banks	3
Privately owned development and investment banks	3
Privately owned participation banks	2
State-owned development and investment bank	1

Source: Microfinance Center.



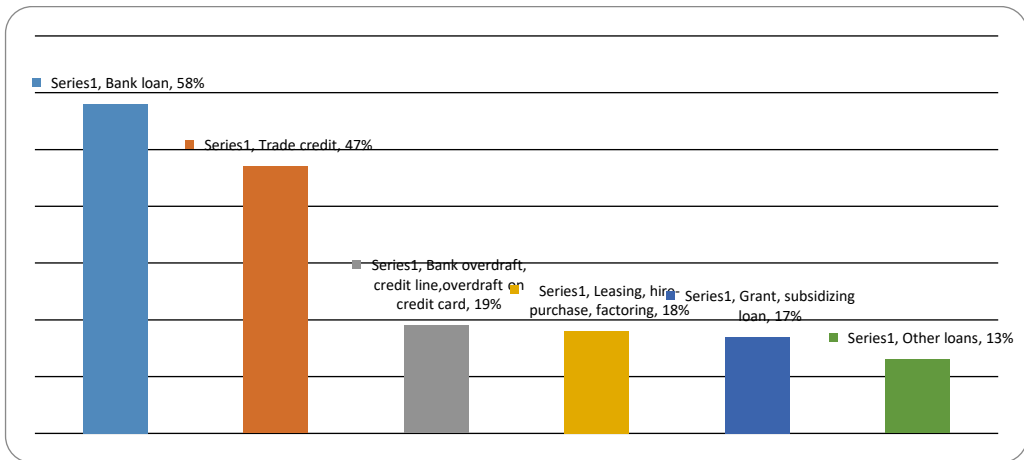
**Graph 1.** Distribution of Credits in Turkey, September 2014.

Source: BRSA, 2014.



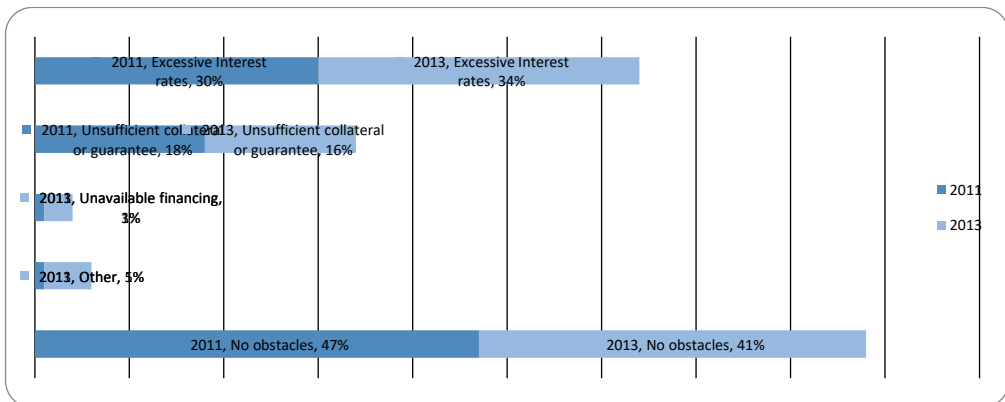
**Graph 2.** Credits of SMEs in Turkey, Billion TL.

Source: BRSA, Turk Banking Sector Main Indicators, September, 2014.



**Graph 3.** Usage of External Financing by SMEs (% firms)

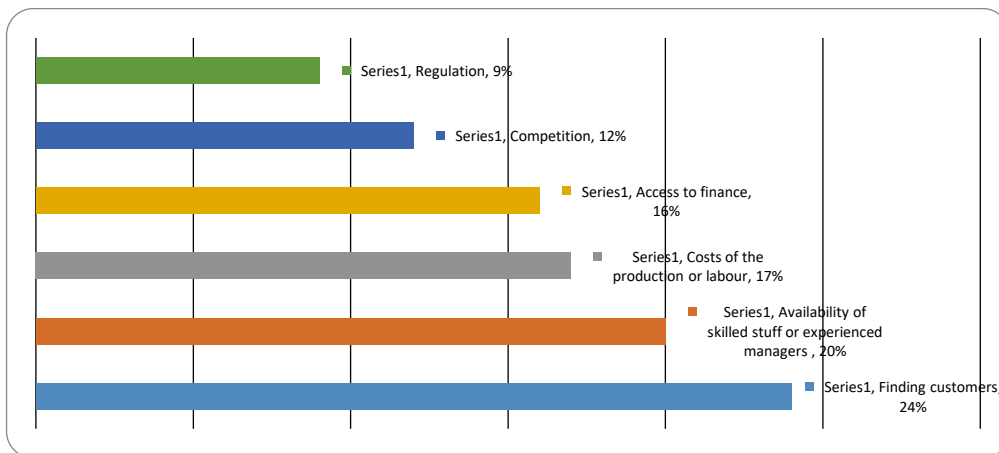
Source: EU SAFE 2013.



**Graph 4.** Significance of Factors Limiting Access to Financing

Source: EU SAFE 2013.





**Graph 5.** Most pressing problems for SMEs

Source: EU SAFE 2013.

---

## The Image and Perceived Quality of Universities as Important Dimensions for Building University Brand Equity -Case Study Involving Albanian Students

**Assoc. Prof. Dr Vjollca HYSI (PANAJOTI)**

University of Tirana, Faculty of Economy

Head of Marketing Department

[vjollcapanajoti@feut.edu.al](mailto:vjollcapanajoti@feut.edu.al)

**Dr. Irma Shyle**

Polytechnic University of Tirana,

Department of Production and Management,

[irmitash@yahoo.com](mailto:irmitash@yahoo.com)

### Abstract

*Research has shown that the probability of employment for individuals lacking proper qualification is four times smaller than that of those who possess proper qualification. Qualification helps people to occupy a decent job, that is to say a good paying job, with quality working conditions supplied by social and legal benefits and protection. A higher education degree is an investment in human capital however and in our country, the cost of this investment per individual is relatively high compared to the expected income. Since the investment to have a university degree is a rare purchase and for most students can be the first and last purchase, therefore the choice of university must be carefully evaluated which means that the image and the university's perceived quality can be the main selection criteria by students. Studies about brands, describe the impact of brand image through identification with the customer. This includes personal identification, where customers can identify themselves with some brands and therefore develop a level of fondness towards them. Therefore it can be suggested that people can enrich their image through the image of the brands they buy and use. Therefore, university students, as the most important group of interest are likely to identify their own self with the university they choose. Images of the university as a brand can be used by students to enrich their image, for example, students can begin to call themselves "boy / girl of X University". Andreassen and Lindestad (1998) have found that consumer retention is influenced by the image of corporate and consumer satisfaction. Within the context of a higher education, loyalty fostered by students can be furthered by the students' own perceived image of the university, as the observed quality of the university. This paper will attempt to treat the influence of perceived quality and image of the Albanian universities as the choice of study provided to Albanian students as well as the impact that these dimensions of brand equity impress upon Albanian universities.*

**Keywords:** university, image, perceived quality, brand equity, student.

### 1. Introduction

This section will deal with two elements of Aaker's CBBE which are strongly correlated to one another: consumer awareness and brand associations linked to the brand image and reputation.

According to Oliver (1980) in assessing the performance of a product or a service, the customer should measure what is worthy and acceptable therefore the brands can create certain expectations. Barich and Kotler emphasize that the role of the image and institutional reputation have an important effect on consumer purchases considerations. According to Kennedy (1997), the image of the institution consists of two main elements: functional and emotional. Nguyen and LeBlanc (2001) define the functional component as tangible characteristics that can be measured easily and emotional component as psychological dimensions manifested in attitudes and feelings about the organization. Raj (1985), Dick and Basu (1994) state that the image and reputation of an institution are important in maintaining consumer loyalty.

Milo, Edson and McEuen (1989) and Weissman (1990) define that the image of the institution and loyalty towards it are used to influence the choice of students towards an institution of higher education. In the study of Treadwell and Harrison (1994) which focuses on the image of the university consisting of students, faculty and staff, it was found that the image of the university was affected by a series of factors: academic excellence, friendships formed, feelings of pride as graduate students, the national image of the school, the image of the school's level of research, social events and homogeneity among students. Attributes of the university that may affect enrollment of students were: family ties, the ranking of schools, departments, teaching quality, the size of the university and the emphasis that was put on sports.

Institutional image is also affected by ancillary services which include: library, computer laboratories, the availability of quiet zones and areas for study. Brand image has a significant impact on quality perceptions when the information regarding the product is not clear, furthermore it provides information on the quality of products and improves the quality of the product or service.

Brand reputation is defined as a perception of quality associated with the name. In the university environment perceived brands can be used by prospective students as a quality indicator. The same happens to the graduates, where the perception of the brand may be determinant in the future willingness to repurchase or recommended the services offered by the university to others. Not necessarily the reputation of a brand is associated with a product or service, the brand is perceived more about the company's reputation than with an individual service.

According to Herbig and Milewicz (1997), reputation should be followed by one user to another, in the case of students, from current students to future ones through word of mouth. Also, they suggest that the university should take care in meeting the expectations of students in order not to lose its reputation. This happens if the course experience is perceived as inappropriate from consumer base. A strong brand name can convey its reputation to new products. However, this may not always have a positive mutual impact. This transfer of reputation can occur even in the case of the university where the perception of a good reputation can be passed from one department to a new department or from one branch to another.

We know that consumers, in making purchasing decisions, consider several aspects such as social status, esteem or prestige associated with their consumer experience while using the brand. Selecting the institution may come from a total of consumer perceptions dependent on various factors: academic reputation, quality and expertise of teaching, the campus environment and attractiveness. (Lin, L. 1997; Mazzarol 1998; Soutar & Turner 2002)

Researches analyze factors associated with the image of the university, where their findings included: factors controlled by the university as separate programs, the power of academic programs, libraries and technical facilities were powerful predictors of image perception as compared to environmental factors: location, costs in connection with other universities and eligibility. Also it was revealed that personal experience in a university was of greater relevance on the image of said university than media exposure.

In the context of the university the best way to reduce perceived risk is considering several factors during the selection process. According to Joseph and Joseph (2000) the most important criteria in the selection are the flexibility and longevity of the program and reputation issues. It was discovered that the information related to: career opportunities, information on choosing a field of study and physical aspects as appropriate location, learning environment, social activities on campus, resource availability and a clean and safe environment are considered the most important factors in choosing a university.

Soutar and Turner (2002) adjudicated to the same conclusion in their study that stated that: a university with a strong academic reputation, high quality teaching, studies they (*students*) wanted, good employment prospects and a campus atmosphere are key predictors of selection and evaluation of a university. Tang (2004) states that: graduates from universities with a better academic reputation have more chances to find a job.

Cornelissen and Thorpe (2002) define the reputation as a collective representation of the unallocated images of the past. Bennett and Kottasz (2000) contradict this definition and add that there is a difference between the image and reputation, because reputation evolves with time and therefore cannot be generated as soon as the image. Dolphin (2004) states that the reputation can be defined as: a spread of opinion regarding an entity or as an interaction between stakeholders in which the organization has no direct impact. Dolphin's determination (2004) also reveals a reputational overlap between the concept of brand image and reputation. Good reputation is important for organizations and particularly important for universities (Hutton et al. 2001).

Nguyen and Leblanc (2001) state that: institutional image and reputation are external perceptions of the organization. Even to a person who has had no experience with the organization, these perceptions can be formed from other sources of information such as advertising and word of mouth (rumors). This is also supported by Ivy (2001) who claims that the institutional image is a result of word of mouth, past experience and marketing activity of the university. According to Veloutsou, Lewis and Paton (2004) students aim to reduce uncertainty by collecting information during the college selection process.

## 2. Perceived quality

The perceived quality concept is defined by Aaker (1991) as an overall assessment of a service experience which includes overall quality or superiority of the product or service related to its purpose and alternatives available.

The dimension of the perceived quality of Aaker consists of two elements: product quality and service quality. Furthermore, he also makes a distinction between perceived quality and objective or concrete quality, based on product quality and quality in manufacturing. Concrete quality relates to superior service. Product quality is based on features, components and manufacturing quality conforms to specifications. On the other hand, Gronroos (2001) describes the quality as technical and functional, which are critical in the service industry. According to him, the technical quality described what the customer gets the service provider and functional quality is the way in which the service was sent.

Aaker also stated that there is a difference between perceived quality and satisfaction. Aldridge and Rowley (1998) agree with Aaker and emphasize that: quality is the general attitude satisfaction is related to specific transactions. It is known that expectations are what determine consumer satisfaction. The consumer can feel comfortable while having low expectations regarding the performance of the service. Aaker also discusses the difference between perceived quality and attitudes. A positive attitude may be due to the price advantages of a product with a subpar quality. Parallel, a person can have a negative attitude towards a high quality product that they feel is over-priced.

The higher education sector, explains the difference between the two elements of quality, perceived quality and cost value. The perceived quality focuses on the quality of university classes and the consistency of the results provided by the university courses. Intrinsic value for the cost associated with building a university environment consists of the value of the course compared to the price, time and effort spent on acquiring knowledge.

Aaker defines the perceived quality of products or services through these differences: Product quality consists of several elements such as product performance, features, consistent with specifications, safety, longevity, usability, and convenience (appears and gives the feeling of a quality product). Quality of service is related to features like: tangible (physical elements of the product, equipment, personnel give you image quality), security, competence of staff to assist and perform their job successfully, is the customer service staff ready to provide assistance in solving your problems, empathy- provide a careful service and personalized service providers.

## 3. Study

The following section presents the proposed model of this search. We used the appropriate literature review and reviewed the methods used to measure consumer-based brand equity using them as the basis of our study. More specifically we attempted to measure brand equity based on the student body of the School of Economics at the University of Tirana. Upon these measures we devised a number of research questions that will yield the following answer.

The importance of student assessment of the image and perceived quality of Albanian universities, has a direct effect on the selection of the university as well as the brand equity of universities.

The sample used for our research is made up of students from the School of Economics at the University of Tirana, from the Bachelor and Master level of studies and from the Part-Time system. The sample selected was comprised of students who have experience with the teaching body, who have completed part or a complete level of studies.

115 students from School of Management (Bachelor), Finance (Master of Science) and Marketing (Master of Science and Professional) were selected as the base of this study. The sample taken has an error interval of 9.72%, a 95% confidence level, which means that the sample is representative.

The selected sample is mitigating non-probability, since the students were chosen from either a group recognized by the teaching body, or a group helping our professors in their teaching hours. They were asked about various issues related to reputation, quality, the support environment of the staff, learning environment, loyalty.

The aim of the research was explained to the participants in broad terms. The respondents were also assured that their responses would remain anonymous. All participants were given the opportunity to participate in the questionnaire and were also given the opportunity to ask questions. Participants were also encouraged to respond to the questionnaire honestly.

The questionnaire was distributed to respondents prior to the commencement of a lecture. The questionnaire was structured with closed questions, except for a question pertaining to brand awareness. Other questions, dealing with university issues, experience, quality and loyalty are in interval form and based on the Likert scale, with five levels: 1-do not agree to 5- very much agrees. The questionnaire was also distributed via the Internet through Qualtrics, a site for the creation and analysis of questionnaires. Analysis of the questionnaires was also made with Qualtrics, which offers the options of cross tabulation that provides a link between variables. Although there are many other sites, or statistical programs, this program seemed as most suitable for our research and more easily usable.

Analysis of the questionnaire is presented with graphics, tables, with data rates and adequate explanations for each question. There is also the analysis of links between different variables which Qualtrics provides through the X2 test. Under this test we should find that the expected frequencies for different values of cross tabulation to be greater than 5 which allows for the latter automatic calculation of the p-value. According to this value could see if there is a relationship between variables.

#### 4. Results

The respondents were 115 students. 89% of respondents were within the 21-24 year old range, 9% in the 18-20 year range and 2% were over the age of 25 years. Of these, 20% were male and 80% were female. About 54% were studying for the MSc or Professional Master Degree, about 45% were finishing their undergraduate studies and about 1%, Part-time. 46. 5% of respondents were enrolled in the Management Department, 25. 5% Marketing 26% Finance and 1. 7% Economics.

The next question pertains to the following "What has influenced the decision to continue the School of Economics of the University of Tirana?" which sheds some evidence on some of the sources of brand equity. Whether word of mouth worked better? If the already established reputation of the school brings sufficient validity of the degree? If other schools are worse, or the inability to choose another? About 46% of respondents answered that they are "agree strongly" about the fact that they have chosen the university because of the validity of the diploma and 43% answered "agree", which means that for these students the established validity of the diploma means more, and the university has exceeded in meeting this standard whereas validating the students assertion that they should feel confident with this choice.

For questions pertaining to private universities, whether these institutions are worth it, the answers tend to hover above the "neutral, agree strongly" line, whereas 29% of respondents to agree. If we join "agree" and "strongly agree" together we will see that 53% of students are of the opinion that private schools are too expensive and generally not worth it. This shows that students are confident in the level and system of public universities and have no confidence in private.

Most of the answers to the question regarding the word-of-mouth from others for the school ranged between the "neutral" and "agree", respectively 40% and 33%, which means that to some extent the decision to choose this university is affected by the word-of-mouth. This, however, confirms the fact that we are influenced by the words of others or their experiences.

About 62% of the respondents answered that they chose the school for its good image. This indicates that the university has managed to create a good image during its years and that this image is conveyed to the consumer. It seems that this is another strong argument favoring the School of Economics. This image is a result of fact that there is a professional academic staff comprised of the best names in their respective field, which has produced students who have established their name in the appropriate fields, etc.

The next question had to do with a selection which was not influenced by the student but rather by other factors (other schools were their first choice). Notwithstanding, 56% of respondents answered that this university has been their first choice and they have willingly chosen to continue their studies here which reinforces the brand image of the school.

To the question whether it was their decision to continue this school or a family influenced one, 63% answered "agree strongly" that the school was selected at their own volition, 36% are "neutral" and 34% "agree" that parents affected their decision. Therefore, in addition to their own opinion it seems that family has a significant impact on the choice. Therefore a positive marketing impact can be drawn from reaching the families of students.

About 58% of students answered "agree", 20% "neutral" and 16% "agree strongly" on the professionalism of the staff. There seems to be a general positive attitude towards them, however, it seems that there are reserves that can be special cases for specific teachers or special students. There are times however, that single isolated instances have a further reaching effect on the whole.

On the question of whether students feel more prepared for the challenges of life the answers were 34% "neutral" and 46% "agree". School programs, experiences obtained and developed practices seem to have managed to create a level of comfort with the challenges upon graduation. The way that students have managed to pass the processes of school, learning, various difficulties seems to have made them stronger to face the challenges of the real world.

30% say "not agree", 33% say "neutral" and 22% "agree" to the question whether the testing of knowledge is based on understanding rather than memorizing. The most commonly accepted term of testing the knowledge obtained is through written examinations. The problem is if you ask for what you have learned over time, for your arguments, analysis, or simply for what you have memorized the book. From the results it appears that students are split between agreeing and disagreeing on the matter. This has to do with ways of learning and what each student decides is the simplest. However a substantial part are of the opinion that exams tend to focus on what each of them has memorized.

Teamwork is very important nowadays, especially when most of the tasks are dependent on or affect other tasks and general communication is very important. 54% of students answered "agree" and 33% "strongly agree" about whether they had some training in teamwork while pursuing their studies. Apparently The School of Economics reached its goal to enable its students to work in a group, although if we take into account the fact that we are a collectivist culture, it should also teach the students to work less individually. Furthermore, to the question whether they were trained in problem solving and analytical thinking, 62% of respondents answered "agree", which is a very good result.

To the question if the curriculum fits with selected trades 54% think "agree". Overall, the classes and curricula developed in class was relevant to the particular profession that the students have eventually followed. However this is an issue that can better judge teachers rather than students. In terms of communication and relationships with the teaching staff 31% answered "not agree", 33% "neutral" and 20% "agree", if teachers are supportive. Also, 30% answered "not agree", 32% "neutral" and 28% "agree", whether it was simple to understand what was expected of them.

So it seems that there is a mix of views, which may have resulted from different opinions and different teachers that make the average being unclear. It seems that not all teachers are good at communicating with their students, not always their relationship with them is satisfactory.

## 5. Analysis research

Earlier we showed the results that emerged from the questionnaire and some of the conclusions that result. These results were presented by means of tables and graphs to facilitate the analysis. Below are some links between different factors, which were handled above. This analysis will be done with the help of Qualtrics. Under this program the value the probability (p) should be smaller than 0.05 so that variables have strong ties with each other. In order that the value of p to be valid  $\chi^2$  or frequency of waiting, must be greater than 5. Calculations of data are made automatically by the program. Also, we have introduced a cross tabulation between variables to indicate frequencies and expected frequencies for each.

First, we will see if the perception of students will affect the image quality perception. We analyzed the quality and image variable in a liaison table and the results are shown in the table below. From the results of tables it seems that many students who assessed the image with agree, strongly agree also assessed the quality in the same manner.

		Good image of the school .		
		Totally not Agree, Not agree, Neutral Agree	Agree, Strongly agree	Total
Compared with others, this university is very high quality	Totally not Agree, Not agree, Neutral Agree	10 7.38	19 21.62	29
	Agree, Strongly agree	19 21.62	66 63.38	
Total		29	85	114

Tab. 1. Cross tabulation, image-quality.

As we can see from the results the value of the probability of  $p = 2$ , which means there is no connection between the variables. This means that the perception of the quality will not be affected by the image. A good image can result in a better quality determination, but quality assessment after creating an experience is not affected by the image. So, students are not affected by the image to evaluate quality.

		Good image of the school	
		Compared with others this has university has a higher quality	X <sup>2</sup>
The error rate	1		
p	0.20		

Table of values

There are two different determinations that we can based upon these results, whereas one can have a very good image but the quality lacks after the experience or vice-versa. Therefore a good image should be supported by good quality. On the other hand we have the variables Image-Fidelity. Even in this case have the greater frequency of responses in the “agree” and “strongly agree” for both variables. Those who have positive comments for the image have shown positive attitude towards loyalty.

		Good image of the school		
		Totally not Agree, Not agree, Neutral Agree	Agree, Strongly agree	Total
I will continue my studies at the university.	Totally not Agree, Not agree, Neutral Agree	13 8.90	22 26.10	35
	Agree, Strongly agree	16 20.10	63 58.90	
Total		29	85	114

Table 3. Cross tabulation fidelity- image.

Considering that the value of  $p = 0.06$  demonstrates that there is a weak relationship between image and loyalty that students show towards the academic staff. A good image will also affect a greater fidelity. This connection is not very strong, but still there is a link, which shows that having a good image will result in higher fidelity to the staff and a return of the students toward this group, as well as to the recommendation to others and in generating good words of the mouth.

		Good image of the school
I will continue my studies at the university	X <sup>2</sup>	3.65
	Shkalla e gabimit	1
	p	0.06

Tab. 4. Table of values.

Now, we will present the results of the case if the perceptions of students for a supportive teaching environment affected their perceptions of quality. In order to make this determination we are considering several variables: quality, expectation, staff support, training in problem solving, the type of test and professionalism of the staff.

The table below shows the results of the values of X<sup>2</sup> and p that show even if there is a relationship between variables. For "It was easy to understand what was expected of me",  $p = 0.08$ , which is greater than 0.05 but less than 0.1. This means that there is a weak relationship between expectations and perceived quality. This indicates that the communication with teachers is important.

For "The staff is supportive and interested in the problems of students",  $p = 0.1$ , indicating that there is no connection between the variable quality with the support of teachers. This means that lack of interest, lack of support or the opposite will not affect the perception of the quality of the staff. To have those qualities is a plus, but you may show interest and be supportive while lacking any skill for your particular profession.

For "I am trained in problem solving and analytical thinking",  $p = 0$ , which means that there is a strong link between training and quality. So, the work that makes school or teachers to enable students will certainly affect their opinion on the quality.

For "Testing is based on understanding and not in memory",  $p = 0.12$ , this value is greater than 0.1 and this means that testing and quality have no link between them. According to respondents, for it does not affect the quality perception of how testing is done.

For "The lecturers are prepared and professional",  $p = 0$ , which is less than 0.01, and means that there is a strong correlation between the quality and professionalism of teachers. So their teaching ability will affect the quality perceived by the students.

		It was easy to understand what was expected of me	Instructors are supportive and interested in the problems of students	Instructors are trained for problem solving and analytical thinking	Testing is based on understanding and not in memory	Instructors are prepared and professional.
I am satisfied with the	X <sup>2</sup>	5.16	6.34	14.85	5.79	19.79



teaching quality	The error rate	2	3	2	3	2
	P	0.08	0.10	0.00	0.12	0.00

Tab. 5. Table of values.

## 6. Conclusions and recommendations

We interviewed students of the School of Economics, the management department, Marketing and Finance from the Undergraduate and Graduate levels. Based upon the conclusions derived from these students we can ascertain that the School of Economics and the University of Tirana are at the forefront of the minds of consumers. It seems that the first effect is created successfully.

Students have chosen the school of Economics at their own volition and it was their first preference. Also, the students have a positive opinion regarding the staff and have chosen the school also because of the good image it has. One other factor that affected has been the influence of family, somewhat. The negative connotation and image presented by the non-public schools, coupled with the positive reputation of the staff have helped in the creation of a better image for the University.

The experience created at a school is very important to decide, whether we like its quality, to validate expectations or to influence the loyalty and relationships that will create it. It seems that in general the experience of teaching is very good, including the professionalism of teachers, the manner of testing, acquired skills, etc.

Results of relations between variables will show the points required for adjustments. First, we link quality image, which indicated that there is a relationship between two variables. This means that the image can lead to a high perceived quality, but this quality must be established. It seems that the image must be supported by a good quality. The image appears to have a strong relationship with loyalty. This may result from the fact that a good image for the staff, can also lead to a better social image. It gives the status of being in college, being an "economics student". And it will also lead to a higher fidelity through the generation of the word of mouth, thus consequently lead to a higher demand for the finest student.

We also examined the link quality teaching- environment. It seems that there is a strong correlation between the quality and perception of expectations, skills and professionalism received from the teaching core. And because the School of Economics was in positive waters with these assessments means that there is a perception of good quality. It seems that the perception of the quality does not affect whether teachers are very supportive or if testing is based on memory or understanding. Most important for students is the ability of the teachers.

## References

- Aaker, DA 1990, 'Brand extensions: The good, the bad, and the ugly', Sloan Management Review, vol. Summer, pp. 47-56.
- Aaker, DA 1991, Managing brand equity. The Free Press, New York.

- Andreassen, TW & Lindestad, B 1998, 'Customer loyalty and complex services: The impact of corporate image on quality, customer satisfaction and loyalty for customers with varying degrees of service expertise', *International Journal of Service Industry Management*, vol. 9, no. 2, pp. 7-2
- Banta, TW 2001, 'Learning communities illustrate principles of good practice', *Assessment Update*, vol. 13, no. 4, pp. 3,16.
- Belen del Rio, A, Vazquez, R & Iglesias, V 2001, 'The effects of brand associations on consumer response', *Journal of Consumer Marketing*, vol. 18, no. 5, pp. 410-25
- Boyer, E 1990, *Campus life: In search of community*, The Carnegie Foundation for the Advancement of Teaching, San Francisco.
- Burgoyne, J & Reynolds, M 1997, *Management learning: Integrating perspectives in theory and practice*. Sage, London
- Dillon, JJ 2003, 'Bringing counseling to the classroom and the residence hall: The university learning community', *Journal of Humanistic Counseling, Education and Development*, vol. 42, no. Fall, pp. 194-208.
- Eisenberger, R, Fasolo, P & Davis-LaMastro, V 1990, 'Perceived organizational support and employee diligence, commitment, and motivation', *Journal of Applied Psychology*, vol. 75, no. 1, pp. 51-9.
- Eisenberger, R, Huntington, R, Hutchison, S & Sowa, D 1986, 'Perceived organizational support'. *Journal of Applied Psychology*, vol. 71, no. 3, pp. 500
- Graeff, TR 1996, 'Using promotional messages to manage the effects of brand and self-image on brand evaluations'. *Journal of Consumer Marketing*, vol. 13, pp. 4-18
- Hogg, MK, Cox, AJ & Keeling, K 2000, 'The impact of self-monitoring on image and congruence and product/brand evaluation', *European Journal of Marketing*, vol. 34, no. 5/6, pp. 641-66.
- Kennedy, SH 1977, 'Nurturing institutional image', *European Journal of Marketing*, vol 11, no. 3, pp. 120-64
- Mackenzie, SB, Podsakoff, PM & Rich, GA 1999, 'Transformational and transactional leadership and salesperson performance'. Working Paper, vol. Indiana University.
- Martens, E & Prosser, M 1998, 'What constitutes high quality teaching and learning and how to assure it', *Quality Assurance in Education*, vol. 6, no. 1, pp. 28-36
- Milo, K, Edson, KC & McEuen, V 1989, 'The impact of negative publicity on institutional reputation and student college choice'. *College and University*, vol. 64, no. 3, pp. 237-45.
- Moore, BL 1995, *Penn State pulse civility*, Pennsylvania State University, Pennsylvania.
- Oliver, RL 1980, 'A cognitive model of the antecedents and consequences of satisfaction decisions'. *Journal of Marketing Research*, vol. 17, no. 4, pp. 460- 9.
- Podsakoff, PM, Mackenzie, SB, Fame, JB & Bachrach, DG 2000, 'Organisational citizenship behaviours: A critical review of the theoretical and empirical literature and suggestions for future research'. *Journal of Management*, vol. 26, no. 3, pp. 513-63.
- Ramsden, P 1991, 'A performance indicator of teaching quality m higher education: The course experience questionnaire'. *Studies in Higher Education*, vol. 16, no. 2, pp. 129-51.
- Scharff, C & Brown, H 2004, 'Thinking through computing: The power of learning communities'. *Computer Science Education*, vol. 14, no. 4, pp. 297-320
- Tang, C & Biggs, JB 1996, 'How Hong Kong students cope with assessment', in DA Watkins & JB Biggs (eds). *The Chinese learner: cultural, psychological and contextual influences*, ACER, Melbourne, pp. 159-82
- Valentine, S, Greller, MM & Richtermeyer, SB 2006, 'Employee job response as a function of ethical context and perceived organization support', *Journal of Business Research*, vol. 59, pp. 582-8.

Veloutsou, C, Lewis, JW & Paton, RA 2004, 'University selection: Information requirements and importance'. The International Journal of Educational Management, vol. 18, no. 3, pp. 160-71

Willits, FK, Janota, JO, Moore, BL & Enerson, DM 1996, Penn state: As a community of learning: A survey report with supplemental readings, Pennsylvania State University, Pennsylvania.

## Waste Management in Ancient Times and Today from the Perspective of Teachers: Reflections to Diaries

Dilek Erduran Avcı

Huriye Deniz Çeliker

Mehmet Akif Ersoy University,  
Education Faculty, Science Education  
Department, Burdur/Turkey.

### Abstract

*Wastes, which are results of human activities, have reached to amounts that threaten the lives of current and future human generations. The only way to create a waste-aware and recycling-aware society is through the education of our children. At this point, science teachers have a key role in formation of recycling generation. With this fact in mind, Project "Look forward, recycle: Recycler teacher" was conducted to make teachers witness the effects of two lifestyles, with and without wastes, to increase their knowledge on the issue, and to develop positive behavior about recycling. This project was conducted with the support of Scientific and Technological Research Council of Turkey and Mehmet Akif Ersoy University in Burdur during August, 2014. Twenty teachers from different provinces of Turkey participated in the project activities. Nature trainings included 23 activities and they were conducted by academic consultancy. In this process, participant teachers wrote diaries about the assigned subjects after completing their daily activities. Diary topics were determined in such a way that the participants could convey their feelings and opinions about the daily activity content. This study covers the results of five activity events and written diaries about them since the activity topics and contents were comprehensive. The names of these five events are as follows: (1) Let us trace the wastes, (2) Where to our wastes travel?, (3) Irregular and regular storage, (4) A journey in history: Introduction to the ancient city of Kibyra, and (5) Waste and waste management in ancient times. Teachers wrote diaries about the subject "Can you compare waste and waste management between ancient times and today?" after completing five events. The analysis of the diaries indicated that almost all teachers displayed an increased awareness and knowledge about waste and recycling increased by means of activities performed in modern technological facilities (purifying, waste collection facilities, wild-landfill storage areas) and historical remains. However, many teachers stated that still standing sewerage system made up of soil and stone of Kibyra ancient city and solid waste landfill site called as Bothros interested them much more rather than the modern technological system. Obviously teachers found waste management of ancient times much nature-friendly in comparison to the modern era.*

**Keywords:** Waste management, recycling, modern technological facilities, ancient times, teachers.

### Introduction

Wastes, which are produced as the results of human activities, have reached to an extend that threatens the lives of the generations of both today and the future (Court of Accounts, 2007). Together with using economic recovery methods like reuse of the wastes, recycling, composting, or energy production, preventing the rapid consumption of natural resources and producing wastes which do not threaten human and environmental health form the basis of "sustainable development". Efficient recovery can be possible by degradation at the source (Court of Accounts, 2007). This fact focuses on conscious consumption behaviors (Bayazit Hayta, 2009). Making each member of our society a recycling-aware consumer can only be achieved by educating our children. The focus of Turkish secondary school science course curriculum has been "educating science literate individuals who have sustainable development awareness" since 2005 (MEB, 2005, 2013). The acquisitions regarding recycling, wastes, sustainability, and other related topics in the curriculum have gained more importance since then. In this context, science course teachers have one of the key roles in shaping a recycling generation (Erduran Avcı & Deniz Çeliker, 2015).

Although there are still locations in Turkey, where wastes could not be gathered and disposed of in accordance with the applicable legislation, efforts and effective applications are conducted in various provinces regarding solid waste storage areas and recycling (Ministry of Environment and Forestry, 2008). Burdur is one of the provinces that started such applications. Both sides of the coin, the negative effects on the nature caused by not recycling wastes and not storing them properly and the efforts to recycle wastes at their source together with the proper storage sites, can be observed in Burdur. This study presents some of the results of a nature training project which was conducted in Burdur. The aims of the project are (i) to make science course teachers experience that living with or without wastes has effects on humans, plants, animals, and environment, (ii) to improve their scientific perspective about this subject, and (iii) to make them gain positive attitude about recycling.

### **“Look forward, recycle: Recycler teacher” Project**

“Look forward, recycle: Recycler teacher” project was conducted from 17th to 23rd August 2104 in Burdur with the support of Scientific and Technological Research Council of Turkey and Mehmet Akif Ersoy University. Twenty science course teachers participated in 23 project activities during their nature training. These activities included discussions about living with and without wastes, facility inspection visits (waste concentration center, waste water treatment facility, solid waste storage areas, etc. ), on-hand activities (composting, producing bio-gases), land and water resource inspection visits (Lake Burdur and Lake Karaçal), and historical site inspection visits.

Wastes and waste management was a problem of ancient people as it is of us today. In this context, teachers tried to understand the approach of ancient people to this problem by visiting the ancient city of Kibyra near Gölhisar, Burdur. During this process, teachers wrote down diaries on given topics after completing the activities. The diary topics were determined as to make the participants express their ideas and opinions on the activity of the day.

Since the number of activities in the project is high, this article is bounded by five activities and the diary results about them. These activities are (1) Let us trace the wastes, (2) Where to our wastes travel? (3) Irregular and regular storage, (4) A journey in history: Introduction to the ancient city of Kibyra, and (5) Waste and waste management in ancient times.

The participants performed their activities regarding the contemporary waste management in waste concentration center, waste water treatment center, and irregular storage area (city dump). They performed their activities regarding waste management in ancient era in Kibyra ancient city. They wrote the diaries after performing their activities about comparing modern waste management with ancient waste management.

### **Method**

This research is a qualitative study. Twenty volunteer science course teachers participated in the study. 13 of the teachers were male and 7 of them were female. The teachers applied for participation using an application form on the internet. The diaries written by the teachers were used as the data collection tools and their content were analyzed using content analysis. The themes, which were extracted via analysis, were supported by the expressions from teacher diaries. Nicknames were used instead of real names for quotes.

### **Findings**

There were four major themes in science course teachers' diaries: learning, self-criticism, emotion, and comparison of ancient and modern eras. Table-1 presents the themes in the diaries and their distribution.

Table 1. Themes and their distribution

Themes	N	
Learning	20	
Self-criticism	13	
Emotion	8	
Ancient-Modern Era	Nature perception	14
Comparison	Waste types	7
	Waste gathering and recycling methods	19

N: Number of teachers

### Learning

Most of the project activity participants stated that they had the opportunity to learn many concepts about which they had non-decent information of misconceptions. The most common of these concepts were bio-degradation, recycling, compost, solid waste storage methods, water treatment, waste types, bio-gas, and bacteria. During the project, teachers both saw the application of the theoretical information they received and sometimes had on-hands experience. They stated that this helped the retention of their newly gained knowledge. Some samples of diary entries are as follows:

*We learnt a lot about bio-degradation and making compost. I learnt that oxygen is required for degradation and burning is not possible in areas to which oxygen does not penetrate. (Kahraman)*

*The activities and research trips we performed blended entertainment with information and they prove that retentive learning is possible this way. (Fatime)*

*We went to the solid waste storage area and could not believe our eyes. There were fumes everywhere. We learnt that the cause of the fumes was methane originating from the dump. We observed the difference between irregular and regular storage. (Özgür)*

*I learnt how bio-degradation occurred and how house wastes are reused via composting. (Tolga)*

*I learnt how wastes are recycled and in which areas they are used. (Sait)*

*Today I added a term, whose meaning I did not know, to my vocabulary: compost. (Aylin)*

### Self-criticism

The teachers expressed that they did not have enough information about wastes and recycling. Moreover, they stated that they were not aware of the way these information affected our daily lives and our environment. Some of the teachers made their own criticism by confessing that they did not make use of their information and skills sensitively. They said that they realized the negative results of their negligent behaviors on nature. Some samples from teachers' expressions which reflected self-criticism are as follows:

*We went to package storing. What a great effort and a great challenge. We act lazily at home and do not parse them but they struggle in that smell and dirt and do it. I will be very careful. . . To make a general evaluation, this was a very beneficial training. I witnessed and learnt many things I did not know about recycling. I will be very keen on this issue at home and at my school. . . We are sinking our world unconsciously. (Hünkar)*

*We were always deceiving ourselves. It was not the global warming, but our negligence and laziness that polluted the nature. (Özgür)*

*After seeing the waste water treatment facility I realized that there were many things I did not know. (Tolga)*

*This activity made me realize the extend the recycling box affected our lives. (Büşra)*

*If we give back what nature gave us, nature will show us her generosity. (Recep)*

*Now I am more aware of waste collection and parsing. (Bilge)*

*The greatest contribution of this training to me is that: I will return back to my students with more information about recycling, a topic I thought I knew, I will share them with my students, and I will educate more conscious students and make them more aware citizens. (Yaşar)*

### Emotion

Teachers made some emotionally negative expressions in their diaries about the places they saw, the information they gained, and the applications they made during the project activities. These expressions indicate that they experienced fear, anxiety, and distress. Some examples of such expressions are as follows:

*This was the first time I wandered around in a dump. I was like watching the backstage of the people who paid great attention to how they looked and the results of their activities. The bad smell in the dump, the slowly burning fire there, and the dead creatures around were like the mourning of universe to humanity. I thought we might die somewhere among the wastes surrounding the world and I was very touched by it. (Jale)*

*We observed the journey of the sewer water in the treatment facility until it becomes clean again. We could not believe what we saw. We inspected how that dirty water which contained solid wastes became clean water again. (Özgür)*

*I noticed that the current status of Lake Burdur was catastrophic and it was about to dry. (Bilge)*

*I feel more disturbed every passing day by the waste density in Turkey, the increasing waste amount due to population and unconscious consumption. (Zeynep)*

*As the result of today's activities, I learnt that the living style of people can be unearthed even after centuries. I am afraid archeologists will speak about how a primitive society we were and how we polluted the nature after unearthing cities of Turkey as ancient cities. (İsmihan)*

*We started the day with the water treatment facility. . . yesterday we went around Lake Burdur and saw no water resource feeding it. Today we learnt that it was only fed by waste water. What will our heritage be to the future generations? I think our wastes will be our only heritage. (Ömer)*

### Comparison of ancient and modern eras

While comparing Kibyra ancient city and modern age of today, teachers heavily criticized modern era. The analysis of the diaries show that this comparison can be categorized to three sub-themes as 'nature perception', 'waste types', and 'waste gathering and recycling methods'.

First of these sub-themes is named as nature perception. Teachers compared the activities of two eras which are performed in order to manage wastes. Most of them found the waste management in ancient Kibyra far more natural than modern Burdur. For instance, İsmihan expressed her opinion regarding this issue as *"...I think that the people of the ancient ages were far more environment-friendly than us despite they lacked today's technology and opportunities. After today's*

activities, I learnt that the living styles of people can be understood even after centuries by excavations. I am afraid archeologists will speak about how a primitive society we were and how we polluted the nature after unearthing cities of Turkey as ancient cities". Özgür stated the difference between the nature perception of the people of two different eras as "the people of that age cared about the nature more than us. . . I managed to see the emphasis that people of ancient times put on art, sports, and environment by observing the theaters, sewer systems, and stadiums they built. I am both happy and sad to see that such people lived on our lands because we cannot see such things in our modern society. Theaters are replaced by television, not even by cinema. We consider only football as sports. Would it be better if we lived in the ancient age?".

The second theme is waste types. Teachers stated that the wastes of ancient era were mostly organic ones which can degrade in nature easily where the wastes of today were various and not nature-friendly. They compared the waste types of two periods by giving examples. For instance, Zeynep wrote: "There are some materials like plastic, glass, metal, or batteries that cannot be recycled enough. They were not used in the ancient times but today we cannot think a life without them." Büşra expressed her observations and her admiration as "The wastes in the ancient era were very natural. Wastes were either remnants of food or pottery which were made of mud. They used to gather them in specific locations. Food remnants were used as fertilizers and the other wastes were transformed to sand in order to be used in grout as a construction material. The waste water was drained from the city regularly via a major channel fed by smaller channels. Today the case is not that easy and healthy. Today I was surprised by every site I saw. I was amazed once again after telling myself that there should not be a more amazing place." Bilge's opinions on the subject were as follows: "Ancient people did not kill their environment like us. There were no plastic and harmful gases were very limited. Even so they built regular sewer systems and waste storage areas. There is no need to say anything about today, especially about our country's status."

The last sub-theme is waste gathering and recycling methods. This sub-theme covers the comparisons between two eras regarding waste gathering and recycling methods. It was a remarkable fact that the teachers compared modern waste storage areas to ancient bothros fields and the materials of modern and ancient sewer and drainage systems. Most of the teachers were amazed by the methods used in ancient times. Regarding this issue, Jale wrote "There were waste gathering areas called "bothros" in ancient times similar to our modern world. They had water channels. But they had enhanced sewer systems water drainage pipes for public areas which we lack today. The ancient people used healthy pipes made of mud instead of today's plastic." Merve expressed her observations in her journal as: "After seeing the ancient city of Kibyra's infrastructure and the place they gathered their wastes, I think that we are not that advanced today. They built the sewer system before building the city. It is a system that travels all the way underneath the city collecting the waste water and a person can traverse in it easily. Moreover, there are pipe systems to drain rain water beneath public places like the stadium. They were transporting the solid wastes which were produced in houses to some pre-determined areas in the city. These wastes were grinded in order to be reused as grout. Today, factory and business wastes are in huge amounts due to industrialization. Rapid increase in human population affects all creatures and natural environment indeed."

## Results

This study presents some of the results of the activities which were performed during Project "Look forward, recycle: Recycler teacher", which compared waste management in modern and ancient times. Participant diaries were inspected in order to find out how teachers evaluated waste management in both eras. Results indicated that teachers' opinions could be categorized into for themes. These themes were learning, self-criticism, emotion, and comparison of ancient and modern eras. Most of the teachers stated that most of the concepts regarding recycling were new to them. Some of the teachers criticized themselves and they stated that their previous knowledge on the issue included many misconceptions. These teachers emphasized that they corrected their misconceptions during the project activities. Another topic about which teachers criticized themselves was not being conscious enough about the environment. They said that they understood the negative effects of their negligent behaviors on nature. This fact caused fear, anxiety, or distress to some of the teachers.

Teachers seriously criticized our modern age in means of harming the nature following the activities conducted in ancient city of Kibyra. Most of them considered the waste management in Kibyra ancient city more natural in comparison to modern era. Furthermore, one of the teachers explicitly expressed this fact by writing "...Would it be better if we lived in the ancient age". Many teachers were amazed by the waste storage and bothros fields, sewer systems, and water drainage pipes of



ancient Kibyra city, all of which survived until today. Some of the teachers stated that waste types of modern era were compound of materials that can hardly degrade and stressed the negative effects of this difference to nature. In short, teachers sadly admitted that the people who lived in ancient city of Kibyra valued their nature more than we do today. The expressions in the diaries of participant teachers indicated that their knowledge, awareness, and consciousness about wastes, recycling and environment increased and they admired ancient era.

Waste management principles hierarchy, which forms the basis of European Union's waste management strategy and is adopted by our national legislation, outlines the basic policies of a healthy and effective waste management system. These principles include reducing the wastes at the source/preventing waste production, maximizing the reuse of the wastes that cannot be prevented by recycling, composting, or converting to energy, and safely storing the wastes that cannot be reused (Court of Accounts, 2007). These principles and targets can only be applied and achieved by the applications of local administrations. But the most important thing in this process is making every individual of the community believe and adopt it. Recycler teachers are the important keys to grow recycler students who will be recycler parents, leading to a recycler society. In this context, the expected outcome of this project is contributing to national targets by educating recycler students via teachers who have this vision.

**Acknowledgements:** This research project was conducted by the support of TÜBİTAK School of Nature and Science Education in 2014 (Project number: 213B704). We would like to thank TÜBİTAK, administrative personnel and academics of MAKÜ, Provincial Administration of Burdur, Burdur Municipality and its personnel, and to all of our participant teachers.

Note: Details about our project and Kibrya ancient city are available on <http://www.mehmetakif.edu.tr/projeler/ileriyebakqeridonustur/> and <http://www.burdur.gov.tr/kibyra.asp>.

## References

- Bayazıt Hayta, A. (2009). Sürdürülebilir tüketim ve aile. *Türkiye Sosyal Araştırmalar Dergisi*, 13 (3), 69-83.
- Erduran Avcı, D. & Deniz Çeliker, H. (2015). The effect of recycler teachers project on science teachers' attitude towards waste and recycling. *Journal of Research in Education and Teaching*. 4 (1), 215-224.
- Turkish Court of Accounts (2007). Waste management in Turkey: Performance audit report. Ankara: T. C. Sayıştay Başkanlığı. [http://www.sayistay.gov.tr/rapor/perdenrap/2007/2007-1AtikYonetimi/2007-Atik\\_Yonetimi\\_Raporu.pdf](http://www.sayistay.gov.tr/rapor/perdenrap/2007/2007-1AtikYonetimi/2007-Atik_Yonetimi_Raporu.pdf)
- Turkish Ministry of Education (2005). Elementary science and Technology course curriculum and handbook. Ankara, Turkey: Devlet kitapları müdürlüğü.
- Turkish Ministry of Education (2013). Secondary school science course curriculum. Ankara, Turkey: Talim Terbiye Kurulu Başkanlığı.
- Turkish Ministry of Environment and Forests (2008). Turkish waste management action plan (2008-2012). Anakara: T. C. Çevre ve Orman Bakanlığı.

## The Importance of Four Skills Reading, Speaking, Writing, Listening in a Lesson Hour

PhD Cand. Lorena Manaj Sadiku

Aleksander Xhuvani University Elbasan Albania

### Abstract

*Teaching and learning are two basic processes underlying the activity of students and teachers nowadays. Learning process puts both parties toward each other, what it teaches, and what it takes, the teacher and the student. Today takes great importance to the training of students to teach themselves, their education, equipping them with the skills of independent work with the most advanced methods of learning conscious, sustainable, active and creative. The purpose of this topic is to know the importance of usage of all skills during a lesson hour. The teacher is free to use a variety of methods and strategies of teaching / learning to suit the needs of students in different classes. He combines these methods during the learning process and adapts according to the increasing development of linguistic competence and independence of student development, the consistency of this process. Teaching has at its center the method of communication, task-based methods, functional methods and situations as real life etc. These methods are realized through various strategies and techniques, according to language skills (listening, speaking, reading, writing). Teacher and students collaborate on the organization of teaching / learning. To facilitate the teaching / learning, the teacher finds efficient ways to organize communication activities, provides and suggests source materials for students. In contemporary teaching teacher does not only play the role of teachers, but also plays the role of supervisor. Together they establish cooperative relations in the process of learning. The teacher clarifies the students and takes their understanding of what happens in the classroom. This means clarifying the rules of the line of work and responsibilities of students in the process of activities. The teacher suggests and provides the use of audiovisual means, electronic, and helps students to use various forms of information technology within and outside the classroom. It gives students the website in accordance with the age and educational requirements. On a teaching hour should be applied all four language skills strategies, but they escalate from level to level depending on the objectives. Setting the students in the spotlight makes the student actively participate in linguistic interaction, preparing it for a new phase of his education or of being able to face the demands of the labor market.*

**Keywords:** Reading, writing, listening, speaking

Any language is difficult and easy. Language serves many purposes. Absence of language is mere dearth of communication. The role that language plays is immense, since time embarked. Identified as the need of the hour, the four necessities in language or commonly known as the four skills- Reading, writing, listening and speaking plays a vital role in any language learning quest... The four skills are the pinnacles of language which will take you to greater heights. They are separate yet bound together with an inseparable bond.

Teachers should set high standards for an ESL classroom. They should work to create the necessary condition for students to learn effectively and reach the desired outcome. For the teaching of English to be successful, the four skills, reading, listening, speaking and writing, should be integrated in an effective way. These skills should be addressed in a way that helps students meet the standards you set for them and develop their communicative competence gradually. This encompasses: **Listening and speaking**: these two skills are highly interrelated and work simultaneously in real life situations. So, the integration of the two aims at fostering effective oral communication. This integration will assure real-life and purposeful communication. **Reading and writing**: they form a strong relationship with each other as skills. They are tools for achieving an effective written communication. Students need opportunities to develop their reading and writing skills. Developing students' competencies in reading and writing requires exposing students to gradually challenging reading materials and writing tasks. The aim is making students read and write effectively.

In fact, the integration of listening and speaking with reading and writing will make learners good listeners, speakers, readers and writers so as to be able to communicate effectively. The mastery of these skills is a gradual process. Teachers, for instance, should expose learners to gradually challenging tasks and material.

When a teacher makes use of activities that have been specially designed to incorporate several language skills simultaneously (such as reading, writing, listening, and writing), they provide their students with situations that allow for well-rounded development and progress in all areas of language learning. In her reflection, Anna refers to activities that make use of 'the four skills' but she is not quite sure how to plan activities that incorporate all four. In this section we will

discuss the 'four skills' as well some activities that can be used in the classroom to promote all four. Through daily activities, teachers provide learners with opportunities to develop each skill: students *listen* (to the teacher use the target language, to a song, to one another in a pair activity), *speak* (pronunciation practice, greetings, dialogue creation or recitation, songs, substitution drills, oral speed reading, role play), *read* (instructions, written grammar drills, cards for playing games, flashcards) and *write* (fill-in-the-blank sheets, sentences that describe a feeling, sight or experience, a dialogue script, a journal entry).

This approach, however, does not combine the four skills so that they can be used together to reach the same end (i. e. language development that is well-rounded).

Two activities that make use of all four skills in tandem are Self-introduction and Reading and Retell. **Self-introduction** takes the answers to a series of personal questions (name, age, grade level, where you live, members of your family, favourite sports, animals, colours, subjects, etc. ) and sequences them into a self introduction. Students are given large visuals to trigger each component of the self introduction. The teacher can point to each picture while modeling a self-introduction (students are *listening*) and then invite learners to introduce themselves (*speaking*) to one or two of their peers. Some of the visuals can then be changed and the students can be invited to introduce themselves to others in the class to whom they have never spoken. This activity can be adapted to become a regular (daily, weekly) warm-up activity to get learners talking in the target language. Having covered *listening* and *speaking* in the oral self-introduction, a scenario can then be created wherein learners must *write* a self-introduction to a potential home stay host. The same picture cues can be used, reconfigured to show a salutation, closing and signature. The picture cues provide learners with support without giving them a text to memorize.

In multilevel SL classes, graded readers can be excellent springboards for another activity that integrates the four skills- **a reading and retell**. First, learners select a book or story at their own level and *read* it. Learners are then given a template to follow to summarize their thoughts about the story (*writing*). The summary is designed to help learners gauge the amount of detail required in a retell. After additional practice *reading* the summary silently and aloud several times, learners are asked to select two or three illustrations from the book to help them tell the story. They then practice telling the story by using the pictures and remembering what they wrote in the template. Students find a partner who has not read the same story and retell (*speaking*) their story to one another using the selected illustrations. Partners not only listen to the retell but also complete a feedback checklist (*writing*) about the retell. After *reading* the feedback, partners switch roles.

### Why are four skills activities useful?

Four skills activities in the language classroom serve many valuable purposes: they give learners scaffolded support, opportunities to create, contexts in which to use the language for exchanges of real information, evidence of their own ability (proof of learning) and, most important, confidence.

Reading is fun-way to knowledge hunt. We read or see innumerable quotes and proverbs on reading. How far is it true? It is true indeed- reading brings wisdom. Through reading, we learn a lot and it is the most prominent language skill. But the fact of making a reading habit or being good at it is the question here. For now, students, adults and even educators read very less. It is a well-known fact that when there were no televisions or computers or other forms of entertainment, reading was a primary leisure activity among the educated lot. People would spend hours reading books and travel to lands far away or enjoy love, cherish victorious moments and live history-in their minds. The tragedy is that, with time, people have lost their skill and passion to read. Reading has declined among every group of people in today's world of technology and entertainment. There are many other exciting and thrilling options available, aside from books. And that is a shame because reading offers a productive approach to improving language- vocabulary and word power for example. When you possess rich vocabulary, you listen better as you understand more; then you can write better with more words to choose from; obviously you can speak better because of your intense word power. It is advisable to indulge in at least half an hour of reading a day to keep abreast of the various styles of writing and new vocabulary. Thus, the need to develop a habit to read is very important. Well, the skills will hopefully jump in automatically once the strong genuine habit has been established. The best and easiest approach is however, to make a small effort to read a piece a day... you will surely succeed.

---

Writing is a gem to pick. A person with good writing skills is always victorious at expressing oneself. The writing skill is the 'hard copy' of your intellectual level or the level of your expression. The writing process is taught in schools and colleges. But, do you practice it in reality? Or Do you start to write as soon as the question is read. Pre Writing opens the doors to effective writing where you brainstorm almost anything under the topic or theme. You find a topic, narrow it, and consider the purpose, audience as well as the form of writing. You are not concerned with creating whole sentences or paragraphs at this point rather you should aim at defining an idea and getting it rolling. Then we write our first draft which is a compilation of our random thoughts. This is where our words form sentences and paragraphs. The third step is revision. Revision means "Seeing again." Here you refine the ideas in their compositions. Revising consists of three activities: rereading the rough draft, sharing the rough draft in a writing group/with anyone, and revising on basis of feedback. You can add or substitute thoughts and words. The same can be done with deleting and moving your words in the draft. Editing is the next big thing. The cleaning up process where the clutter is cleared and ideas are allowed to shine happens here. We tend to putting the piece of writing into its final form and you fine-tune your work by focusing on correct punctuation, capitalization, grammar, usage, and paragraphing. The goal here is to make the writing 'optimally readable.' The last is publishing your final piece. Each step is interchangeable and can be done as many as you dare or till your writing perfects. I always tell my students to work out at least three drafts. So this is it with writing...easy? It would turn out simply simple if you make it a habit and practice like you practice your favourite song or dance. Tip: Avoid electronic English (*u* for you)

Listening is yet another necessitate in language. The more efficient a listener you are... the more successful and satisfied you will be. *Listening...is not merely hearing: it is a state of receptivity that permits understanding of what is heard and grants the listener full partnership in the communication process.* We need to develop a keen interest in making ourselves better ears. The fact that we listen more than our ears and we listen far more than the sound is very true. As any member in a society, listening is one important skill to possess as good listening is an integral part of communication process. A good listener shows readiness and possesses an ability to manipulate the sound into words and their contextual meaning. Then the good listener relates given meanings to other experiences and he shares responsibility with the speaker. Academically, listening skills plays a vital role in the teaching-learning cycle. A student learns better when he can listen better. A teacher is also in need of a good listening skill. All the way, listening should be enhanced in your life as to be a greater speaker. The attitude of the listener is another stepping stone to achieve this skill.

Speaking is all special. This skill is as important as the others. When you have words read, ideas written and thoughts heard, all you need is to express- your speaking skill. What you speak will determine the expressiveness in you. Speaking has many masks- public, friendly or academic contexts are few from the lot. Each context has the same need for the skill. Statistics reveal that when you talk, you use about five syllables per second and there are more than forty different speech sounds. Thus, every time you talk, your audience must catch all the five syllables per second out of the air, must recognize the forty sounds in them, must translate the syllables into words and finally they must translate the words into thoughts- you got to help them succeed in doing so. If you slur or muffle sounds, or project the sounds weakly, the listener will miss a lot, failing you as a good speaker. Therefore, proper pronunciation, diction and building a good vocabulary should be on your prioritized list. Tip: Avoid one word answers or queries.

As a student, the skills of language will make you academically sound and the miracle it will have when you enter the world as an adult is magical in an adventure. Mind you, the four skills never stand out as individual areas but they form a chain cycle, where you break one ring of the chain and the whole chain would collapse. In the changing competitive world, your command over a language and even more the level of your English can determine your life.

Thus, it is so much imperative for you to understand the four skills and give it a consistent effort. The result will be astonishing!

---

## Digital Generation - Analysis of the Use of ICT by Young Poles

**Dr Agnieszka Stanimir**

Wroclaw University of Economics

Komandorska 118/120

53-345 Wroclaw, Poland

agnieszka.stanimir@ue.wroc.pl

### Abstract

*In the Europe 2020 strategy in area of smart growth one of the flagship initiatives is Digital Agenda for Europe. Implementation of this initiative will lead to wide-availability of ICT solutions to society. Young people belonging to Generation Y most often treat the computer as a natural household equipment. Regular use of the Internet is very popular among them. They increasingly use mobile solutions in the field of ICT. The intelligent use of information technology possibilities will lead to sustainable economic growth. The purpose of the study was to cheque changes in the use of ICT among young Poles, and whether related behavioural patterns are similar in other countries of the European Union. The paper concludes with main reasons differencing generations in Poland due to the using the Internet.*

**Keywords:** digital society, ICT, generations Y, X, BB, digital divide

### 1. Introduction

In 2010, were determined actions to smart, sustainable and inclusive growth of the economy and society of the European Union. It was Europe 2020 strategy. Each of the three assigned objectives are highlighted by a number of priorities, the implementation of which is constantly checked with use of selected indicators. "Smart growth means ... making full use of information and communication technologies and ensuring that innovative ideas can be turned into new products and services that create growth, quality jobs and help address European and global societal challenges" (European Commission, 2010b, p. 11).

The process of smart growth based on social inclusion is very difficult to achieve considering the very different levels of economic development in the EU member states. For example the use of Information and Communication Technologies (ICT) differs in many countries (European Commission 2010a, p. 9). In addition, in the Member States there are differences in the skills of handling and use of ICT by younger and older residents, at work and private life (in European Commission (2010a, p. 10) can be found that "age and education are the two main factors influencing the way people use internet services"). In a dynamic economy based on modern technologies, limiting access to ICT is the cause of the digital divide, which results in social exclusion (Wykluczenie cyfrowe ..., 2010).

The aim of the study was to find if the purposes of Europe 2020 strategy are fulfil in Poland and to find differences of use of ICT between adult generations in Poland.

### 2. Europe 2020 strategy - smart growth

"EU flagship initiative "A digital agenda for Europe" to speed up the roll-out of high-speed internet and reap the benefits of a digital single market for households and firms" (European Commission 2010b, p. 33). Limitation of the availability of ICT can lead to social exclusion, particularly the digital divide.

In Wykluczenie cyfrowe (2010) can be found several definitions of the digital divide:

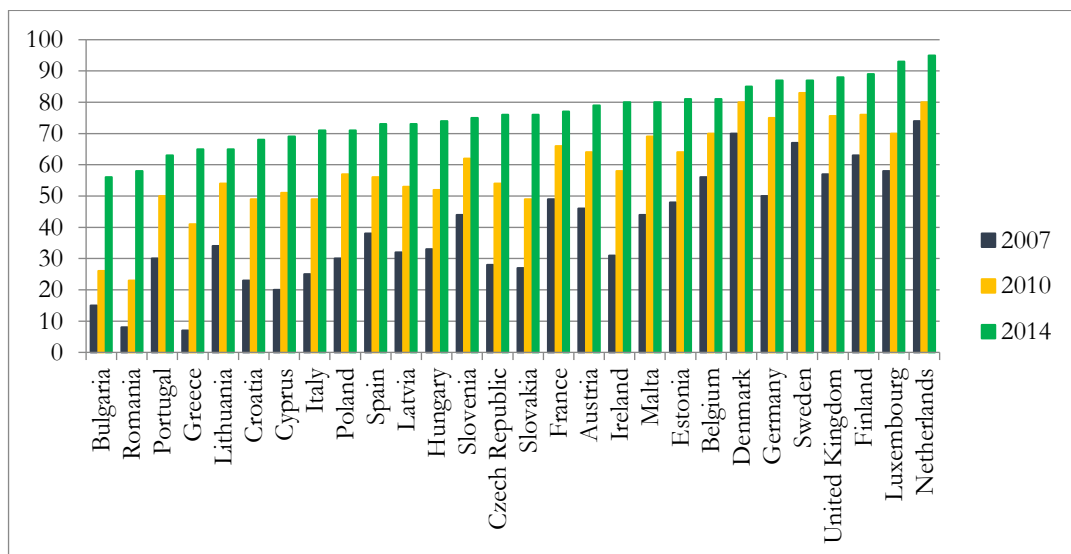
- division of society to having access to ICTs and those who do not have access;

- division due to the possibility of obtaining access to a computer and the Internet and skills of use these technologies in private life and at work;
- complex, global division of individuals, households, countries, regions, businesses, taking into account access, skills and use of ICT.

As seen above division of social exclusion can lead to many difficulties in job search and social acceptance, and in extreme cases to discrimination of individuals.

Information society in Poland in 2010 was rated significantly worse than in most member states of the EU (Figure 1). This situation has changed in 2014 years.

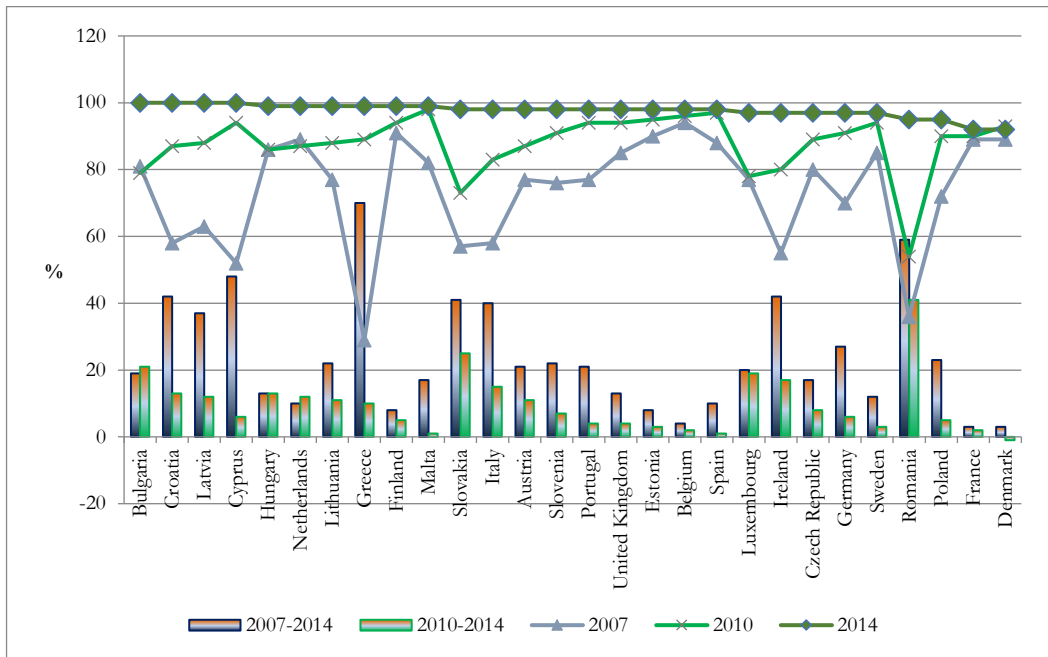
**Fig 1:** Percentage of households with broadband Internet connection



Source: Own elaboration on EUROSTAT data (isoc\_pibi\_hba).

**Fig 2:** Percentage of households with broadband Internet connection at home<sup>1</sup>

<sup>1</sup> With bar chart are shown increases of access at home of households to broadband Internet (2007-2014 and 2010-2014), with lines are shown Percentages of households with broadband Internet connection at home in 2007, 2010, 2014.



Source: Own elaboration on EUROSTAT data (isoc\_pibi\_hba).

Figure 1 shows the changing number of households with access to broadband Internet. In Poland in 2007, such access was available in 30% of households (20th place among the current 28 Member States of the EU), in 2010 - 57% (ranked 15th), in 2014 - 71% of households (20th place). Since 2007 until 2014 the percentage of households with access to a broad band Internet increased by 41 percentage points. This is the 11th result of EU Member States.

The situation is better given access at home of households to broadband Internet (Figure 2). Since 2007 up to 2010 the percentage of households with broadband Internet access increased by 23 percentage points, from 72% in 2007 to 90% in 2010 and then 95% in 2014). By 2014, four countries have 100% of households access to broadband Internet at home, households from six countries have access in 99%, 98% of households in 9 countries, from 5 countries 97% of households, from 2 countries 95% of households (including Poland), from 2 countries 92% of households have broadband Internet access at home. In 2007 the lowest access at home of households to broadband Internet were observed in Greece and in Romania. Both of these countries made great progress in access to the Internet. In 2014 in Greece 99% of households have access at home to broadband Internet, and in Romania - 95%.

The latest report on the implementation of new Digital Economy and Society Index - DESI (European Commission 2014) shows compressed information about Internet skills, the use of online activities, digital technologies and digital public services. Table 1 and Figure 3 shows ranks<sup>1</sup> calculated of three indices: DESI, percentage of households in 2014 with access at home to broadband Internet (R2014), increase since 2007 to 2014 of access of households with access at home to broadband Internet (R2007-2014). The pair correlations were measured with use of Spearman Index.

Figure 3 presents the rank allocated in three variables for each country. Poland is ordered in the far position for DESI and R2014, but for R2007-2014 Poland is ranked much better. This means that across five main dimensions (Connectivity,

<sup>1</sup> The indices were ranked after ordering values from best to worst. The indices were ranked after ordering values from best to worst. After ordering the indices from best to worst ranked. Rank 1 represents the best country, rank 28 - the worst. In the case of variable R2014 occurs many countries with identical values of the indices. In this situation were used linked ranks.

Human Capital, Use of Internet, Integration of Digital Technology, Digital Public Services) the Poles are a lot worse evaluated in comparison to people in most other Member States of EU. In 95% of Polish households at home have access to broadband Internet, it is only the result lower of 4 percentage points than the best countries, but it shows that in this matter in Poland there is still need for further development. The last indicator R2007-2014, shows a large increase in the number of Polish households having access at home to broadband Internet. Figure 4 presents the correlations between analyzed variables. Highest relationship is found between DESI and R2007-2014. The correlation is inversely proportional. This means that an increase in access to broadband Internet not directly cause an increase, but a decrease in its ability to operate and use. An analogous conclusion can be found in Krajowy Program Reform (2014). There is indicated the need to "improve the quality of education, . . . , make full use of ICT, as well as ensuring that the innovative ideas can be turned into new products and services that contribute to the increasing economic growth, creating new work places and solving social problems" (Krajowy Program Reform 2014, p. 22).

Since the widely used characteristic of Gen Y is constant and natural use of ICT in everyday life and work, so it becomes increasingly important question if there are significant differences in the use of the Internet and other modern technologies for Generation Y and Generation X, Baby Boomers (BB). Combes (2009, p. 31) writes that because " they have never known a world without the Internet and technological change", so their skills in use of technology are almost intuitive. Therefore, the chapter 3 presents an analysis of the use of the Internet in Poland.

**Table1.** Ranks of three indexes: DESI, R2014, R2007-2014

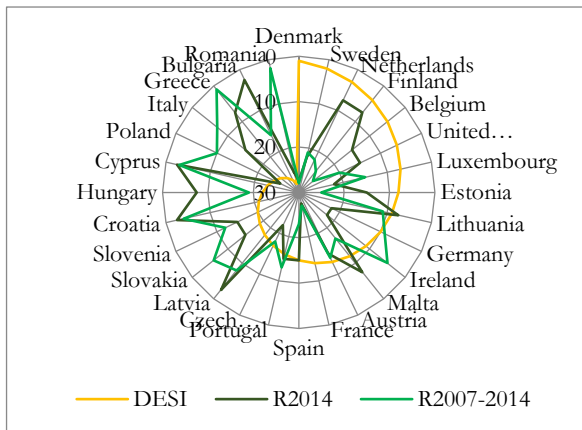
Country	DESI	R2014	R2007-2014
Austria	13	15	14
Belgium	5	15	26
Bulgaria	27	2,5	16
Croatia	24	2,5	4
Cyprus	22	2,5	3
Czech Republic	17	22	18
Denmark	1	27,5	27
Estonia	12	15	25
Finland	4	7,5	24
France	14	27,5	27
Germany	10	22	9
Greece	26	7,5	1
Hungary	20	7,5	19
Ireland	9	22	5
Italy	25	15	7
Latvia	18	2,5	8
Lithuania	11	7,5	11
Luxembourg	8	22	15
Malta	15	7,5	17



Netherlands	3	7,5	22
Poland	23	25,5	10
Portugal	16	15	13
Romania	28	25,5	2
Slovakia	21	15	6
Slovenia	19	15	12
Spain	7	15	23
Sweden	2	22	21
UK	6	15	20

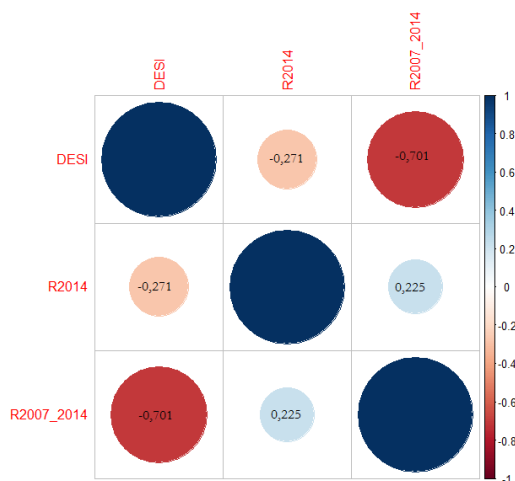
Source: Own elaboration on EUROSTAT data (isoc\_pibi\_hba) and European Commission (2014).

**Fig 3:** Ranks of three indices: DESI, R2014, R2007-2014



Source: Source: Own elaboration on EUROSTAT data (isoc\_pibi\_hba) and European Commission (2014).

**Fig 4:** Correlations between ranks of three indexes: DESI, R2014, R2007-2014

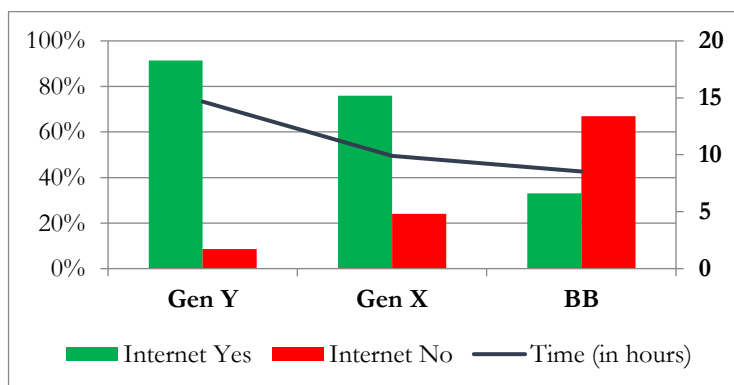


Source: Source: Own elaboration on EUROSTAT data (isoc\_pibi\_hba) and European Commission (2014).

### 3. Use of the Internet – differences between Generations Y, X and BB

Use of the Internet by the Poles were checked on the basis of data from the Diagnoza Społeczna 2013 (ang. Social Diagnosis [Rada Monitoringu Społecznego, 2013]). Analysed age groups were as follow: Gen Y (aged 18-33), Gen X (aged 34-48), BB generation (age 49-67). Firstly, from the respondents were taken only Internet users, because subsequently was checked for what purpose they use the Internet<sup>1</sup>. Figure 1 presents rate of Internet users of three generations and average time spend on the Internet in last week (last week before date of interview). 91% of Gen Y were Internet users and spent in 2013 almost 15 hours per week on the Internet. Among Generation X the rate of Internet users is lower – 76% (10 hours per week spent on Internet). The rate for BB Generation is the lowest. Only 33% used the Internet, but the time spent on the Internet was almost the same as for Gen X - 9 hours per week.

Fig 5: Rate of Internet users and average time on Internet in last week (in hours) in 2013

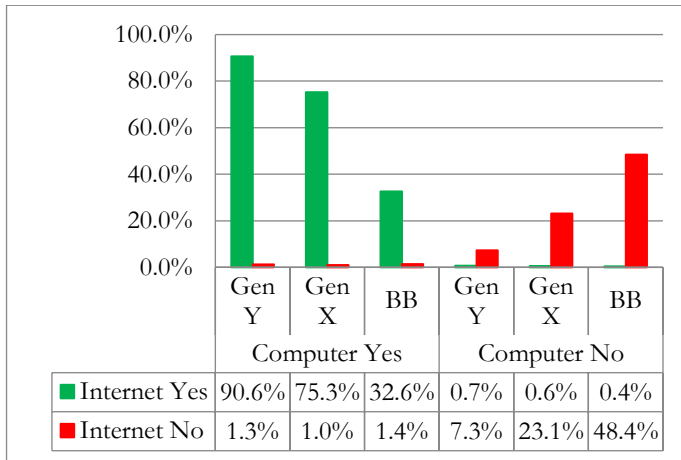


Source: Own elaboration on Diagnoza Społeczna [Rada Monitoringu Społecznego, 2013].

<sup>1</sup> Literal questions: Do you use a computer? and Do you use the Internet?

Figure 6 show the rate of computer and Internet user. Rates of persons who didn't used computer are lower than for users. Some of persons who used computers in 2013 didn't used the Internet: 1,3% of Gen Y, 1% of Gen X, 1,4% of BB.

**Fig 6:** Rate of computer and Internet users in 2013



Source: Own elaboration on Diagnoza Społeczna [Rada Monitoringu Społecznego, 2013].

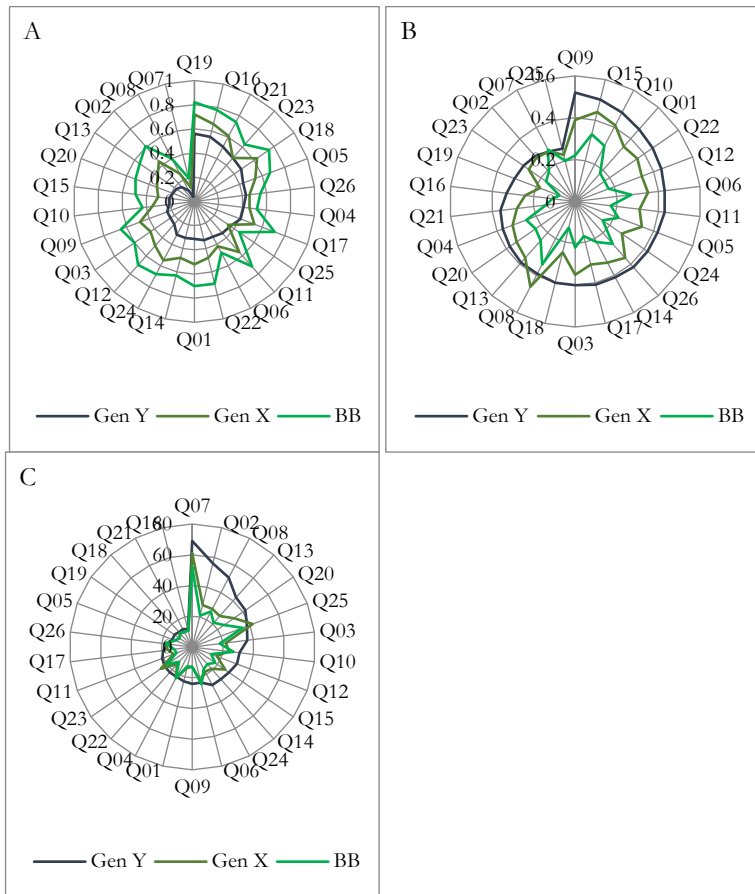
Next analysis was conducted for reasons to use the Internet and frequency of use of the Internet for all reason.

Analysed reasons were grouped in 10 subjects:

- social networking (Q1 participating in discussion groups or forums; Q2 Facebook; Q3 social network);
- searches (Q4 obtaining information from websites of public institutions, Q5 ticket reservation);
- reading (Q6 reading newspapers or books on the Internet);
- communication (Q7 e-mail, Q8 the use of instant messaging, Q9 chats, Q10 phone calls (VoIP, Skype));
- multimedia sites (Q11 free software downloading, Q12 free music and movies downloading, Q13 listening to music or the radio, Q14 watching TV)
- shopping (Q15 purchases of products and services in Poland, Q16 purchase products and services from abroad, Q17 participating in online auctions);
- own creativity (Q18 creating or modifying a web pages, Q19 creating or modifying own texts (eg. a blog, twitter), graphics, music or others);
- learning and working (Q20 collection of materials needed for study or work, Q21 participation in courses or trainings, Q22 job search, sending offers for employment, Q23 home use of the Internet and e-mail for professional purposes);
- online games (Q24 online games);
- official matters (Q25 Internet banking, Q26 downloading or filling official forms).

**Fig 7:** The reasons for using the internet (A – never; B – ever, C – last week<sup>1</sup>)

<sup>1</sup> Last week before date of interview in 2013.



Source: Own elaboration on Diagnoza Społeczna [Rada Monitoringu Społecznego, 2013].

Between *never users* (Figure 7A) from three analysed generations were large differences in 2013. The category *I never use the Internet for referred reasons* was most popular for BB generation in 2013. More than 60% of Gen Y never used in 2013 the Internet for buying products and services from abroad (Q16), creating or modifying own texts (eg. a blog, twitter), graphics, music or others (Q19) and participating in courses or trainings (Q21).

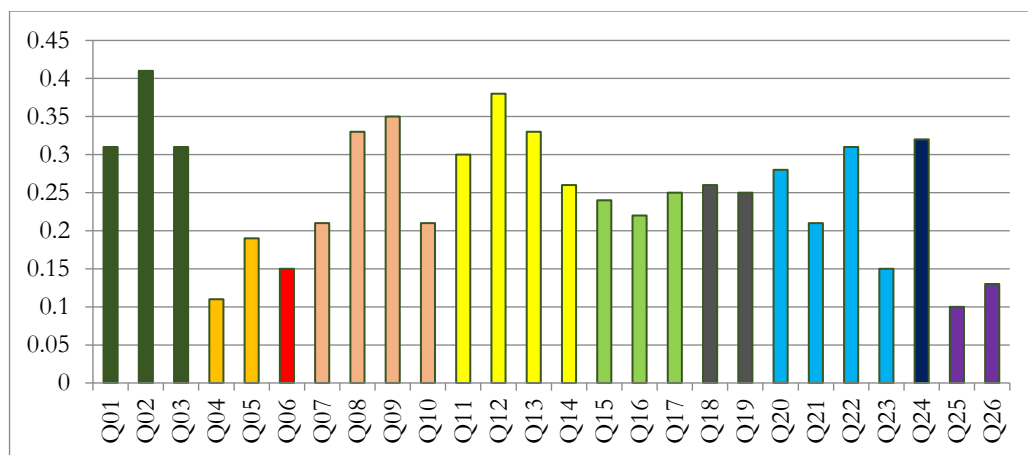
Most people of ever used the Internet in 2013 (Figure 7B) belongs to the generation Y followed Gen X, and the lower number of persons ever used the Internet was from BB generation. The highest level of the internet use was for buying products and services in Poland (Q15) for all generations. Many people from Gen Y ever used the Internet in order to chats (Q9). Gen X used ever the Internet for instant messaging (Q8), like BB generation.

In Figure 7C last week means a few days prior to the interview in 2013. In all age groups in last week very popular reason for using the Internet was communication via e-mail. Almost the same rates of all generations of Internet users in 2013 used the Internet for Internet banking (Q25), reading newspapers or books (Q6), obtaining information from websites of public institutions (Q4), downloading or filling official forms (Q26). The lowest percentage of people in each age group indicated the use of the Internet to ticket reservation (Q5), own creativity (Q19 and Q18), participating in courses or trainings (Q21), buying products and services from abroad (Q16).

Parment (2013, p. 39) writes that "Die Generation Y ist daran gewohnt, das Internet als Informationsquelle und Wissensbasis zu nutzen" (Generation Y is accustomed to use the Internet as a source of information and knowledge base). In Poland in 2013 use of the Internet for information searching was quite different: 40% of Gen Y declared that never used the Internet for obtaining information from websites of public institutions (Q4), 37% used ever the Internet for Q4 reason and only 22% used the Internet for searching information in last week.

In Figure 8 are shown values of Phi correlation coefficient between generations and reasons for using the Internet. The most influencing reasons differencing generations was in 2013 Q2, i. e. using the Internet for connecting with Facebook. Next, very important reasons for using the Internet which differ among generations were free music and movies downloading (Q12), the use of instant messaging (Q8), chats (Q9), online games (Q24).

**Fig 8:** Phi coefficient of generations versus reasons for using the Internet



Source: Own elaboration on Diagnoza Społeczna [Rada Monitoringu Społecznego, 2013].

#### 4. Conclusions

The conducted analysis showed that between EU countries are differences in the use of the Internet. During the analysis of the behavior of Poles using the Internet also were indicated differences that reflect the generational change.

Poland has one of the highest indexes of increase since 2007 to 2014 of households with access at home to broadband Internet R2007-2014 and the lowest index of DESI. As Punie, Zinnbauer and Cabrera (2008, p. 7) wrote that between Member States in 2006 were "three clusters of countries: A cluster of "high performing countries" ...; A cluster of "average performing countries"..., A cluster of so-called "delayed countries" ...". This statement was made for educational system, but may be that the situation in education in 2006 influencing the situation in use of new digital technologies in 2014. In explanation of DESI indices for 2014 may be find the same information about countries and digital society in EU: "According to their performance, countries were grouped in high, medium and low performance clusters" (Digital Agenda, 2015) – Poland is in the last group.

Analysis of reasons for using the Internet (in last week) among constantly Internet users pointed out that there is no generational differences in the use of the Internet to Internet banking (Q25), reading newspapers or books on the Internet (Q6), obtaining information from websites of public Institutions (Q4), downloading or filling official forms (Q26). The biggest differences are in the use of Facebook (Q2), instant messaging (Q8), listening to music or the radio (Q13) – the young Poles use for these purposes the Internet more frequently than older.

The least frequent reason given for not using the Internet is email (Q7). Other causes are arranged in order of priority in the same way for all generations. The share of people never using the Internet for the specified purposes is the highest among BB generation.

The most differentiating generations reasons for using the Internet is a social networking (especially use of Facebook), communication (specially chats), multimedia sites (the most free music and movies downloading). Between generations in Poland there is no difference due to the following reasons for the use of Internet: searches, reading and official matters.

## 5. Acknowledgements

This study was done as a part of the project "Non-metric multivariate data analysis as a tool for study of adults situation in the context of demographic changes" financed by Narodowe Centrum Nauki (National Science Centre) in Poland. Project number: 2012/05/B/HS4/02499.

## References

- Combes B. (2009). Generation Y: Are they really digital natives or more like digital refugees? *Synergy*, vol. 7, nr. 1, 31-40.
- Digital Agenda for Europe (2015). The Digital Economy and Society Index (DESI). [Online] Available <http://ec.europa.eu/digital-agenda/en/digital-economy-and-society-index-desi> (March 1, 2015).
- European Commission (2010a). *Europe's Digital Competitiveness Report 2010*. Publications Office of the European Union, Luxembourg, doi: 10.2759/32382.
- European Commission (2010b). *Communication from the Commission - Europe 2020. A strategy for smart, sustainable and inclusive growth*. European Commission, COM (2010) 2020 final.
- European Commission (2014). How digital is your country? New figures reveal progress needed towards a digital Europe. European Commission - Press release, Brussels. [Online] Available [http://europa.eu/rapid/press-release\\_IP-15-4475\\_en.htm](http://europa.eu/rapid/press-release_IP-15-4475_en.htm) (February 26, 2015).
- Krajowy Program Reform. Europa 2020 (2014) Rada Ministrów, Aktualizacja 20-14/2015, Warszawa. [Online] Available [http://www.mg.gov.pl/files/upload/8413/KPR\\_2014-2015.pdf](http://www.mg.gov.pl/files/upload/8413/KPR_2014-2015.pdf) (February 27, 2015).
- Parment A. (2013). *Die Generation Y Mitarbeiter der Zukunft motivieren, integrieren, führen*, Springer Fachmedien Wiesbaden.
- Punie Y., Zinnbauer D., Cabrera M. (2008). *A Review of the Impact of ICT on Learning*. Joint Research Centre. Office for Official Publications of the European Communities, Luxembourg.
- Rada Monitoringu Społecznego ([2013]). *Diagnoza społeczna: zintegrowana baza danych*. [www.diagnoza.com](http://www.diagnoza.com) [retrieved 2014/07/18].
- Wykluczenie cyfrowe na rynku pracy* [2010], red. E. Kryńska, Ł. Arendt, IPiSS, Warszawa.

## The Analysis of Interpersonal Conflict Resolution Approaches of University Students by Grade Level and Gender

**Abdülkadir Avcı**

PhD Student, Süleyman Demirel University, kadir35d@yahoo. com

**Bilge Aydaş**

PhD Student, Süleyman Demirel University, baydas69@mynet. com

**Özgür Arlı**

PhD Student, Turkish Military Academy, ozgurarli1212@hotmail. com

### Abstract

*Purposes of this study are to examine the interpersonal conflict solving approaches of university students and to detect whether these preferences changes according to grade level and gender. The sample of the study involves data obtained from 200 students from Mehmet Akif Ersoy University, Faculty of Education in 2009-2010 academic year spring term. Survey is used as data collection method of the study and "conflict communication scale" made by Goldstein (1999) is revised to Turkish by Arslan, 2005 as "interpersonal conflict solving approach scale" is used as scale instrument. According to this, interactions in conflict process consist of Confrontation, Public/Private Behavior, Emotional Expression, Conflict Approach/Avoidance, Self-Disclosure approaches which focus on communication styles in communication process. ANOVA and t-test statistics analysis are made to investigate the alteration of students interpersonal conflict management approaches according to grade level and gender. Study results point out that "confrontation" approach scores are the highest and "Public/Private Behavior" approach scores are the lowest according to others. There are significant differences between "conflict approach/avoidance" approach scores of first and fourth grade students and "Public/Private Behavior" approach scores between second and third grade and third and fourth grade students. When it was analyzed with the perspective of gender, it is concluded that there is a significant differences in favor of male students in approach scores of "Public/Private Behavior" and "confrontation".*

**Keywords:** Conflict management, gender, grade level, interpersonal conflict, university students.

### Introduction

In the literature, it appears that there is no consensus on the definition of the concept of conflict. This is because of the fact that conflict is not only field of management, but also fields of economics, sociology, anthropology, psychology and political science. (Korkmaz, 1994, p. 78) Besides, all the disciplines define conflict with their own terms. (Şahin, 2006, p. 15). Dictionary of Turkish Language Association defines conflict as "Mental condition of the individual whose requests and desires are equally attractive or opposing, and sad state of consciousness arising from the competition of wishes or desires which are incompatible with each other". Conflict is not just a specific behavior of people. In addition, conflict can be defined as "disputes arising between two or more people or groups from various sources". No matter how it is defined, dispute, conflict, disharmony and opposition are the basic elements of conflict. " (Koçel, 2003, p. 664) .

Rahim generalizes these definitions of conflict and describes it as "the interaction process emerging as mismatch, dispute or disagreement between or in the social assets (individuals, groups, organizations, etc. )" (Rahim, 2002, p. 207) . Although the definitions of conflict concept varies according to different authors, there is some commonality. (İpek, 2000, p. 221) .

These are,

1. Conflict is not static, but a dynamic process. ,

2. The conflict must be perceived by the parties.
3. Conflict has two dimensions with its positive and negative aspects.
4. Any conflict involves preference difficulty between two or more options.
5. There are frictions, conflicts and contradictions arise from different purposes, thoughts, ideas and so on in conflicts.

### **Interpersonal Conflict**

Although interpersonal conflict is defined as a mismatch between the people, there is no generally accepted definition in the literature. However, we can define interpersonal conflict as "a phenomenon caused by negative emotional reactions to feel each other with the perception of interventions and consisting the situations of conflict environmental (interdependence), cognitive (dispute), behavioral (blocking) and emotional (negative emotions) elements" (Barki and Hartwick, 2004).

Interpersonal conflict can be caused by various reasons. These reasons are mostly stem from personal, environmental, cultural or communicational bases. Conflict behavior basically comes from personal needs and interests, and these issues are surrounded by the factors of communication, emotions, past, structure and values. All these factors directly affect individual needs and interests, and also emerge as causes of conflict behavior influenced by the needs and interests (Moore , 2003, p. 64).

### **Conflict Resolution Approaches**

Although there are a number of different approaches and models regarding conflict management styles, it is seemed that most of these studies are based on the studies of Blake and Mounton states that people are basically interested either in own or others aims in conflict management. This approach is known as "Dual Concern Model" in literature (Janssen vd. , 1996,p. 101). Many researchers used Blake and Mounton as baseline and developed different models. Thomas, in 1976, stated that individuals display either competitive behavior by considering their own interests and aims or collaborative behavior by thinking others expectations and gains during conflict. In this model, there are five conflict-handling styles based on two dimensions: assertiveness and cooperativeness. (Ma, 2005,p. 174; Sorenson etc. , 1999,p. 26). Along with same principals, Rahim also classified conflict management styles as unifying, oppressing or domination, benevolent and avoiding and compromising using the two dimension model mentioned above, (Rahim ve Bonoma, 1979; Rahim, 1983,p. 369). Hall (1973) described two dimensional behavioral patterns as win-lose, surrender-lose and compromise-synergy (Shockley-Zalabak, 1988,p. 304-305).

When the fact that interpersonal conflict is a reciprocal interaction process between parties, and this process is affected by a number of contexts such as, culture, environment, and personal structure in which people are in is taken in to consideration, role of communication in this process becomes even more prominent (Basim, Çetin ve Meydan 2009). In order to increase individual involvement in conflict process and parties' positions and behaviors, together with the outcome of the conflict communication process within the conflict need to be taken in to account (Goldstein, 1999). During a conflict, people display behavior and communication style, due to the environmental and personal factors. Goldstein (1999) developed a scale which focused on behavioral patterns of individuals within the conflict process. This scale is composed of 5 other sub-scales. This part of the study is based on this philosophy, it is comprised of communication ways that take into account individual's interaction through conflict process, such as confrontation, general/specific behavior, closing/avoiding, self-disclosure and emotional expression.

These are;

a. Confrontation: First step in conflict resolution process towards eliminating conflict is the confrontation of the parties. In confrontation, cultural values among individuals are important, however confrontation itself plays and effective and important role.



b. General/Specific Behavior: General behavior indicates people's comfort in environment and relaxed and easy going display with their attitudes. Specific behavior shows individuals either are not able to display their all behaviors or just able to present all within a particular/specific situation. This approach means that in terms of individual's behaviors displayed during conflict, feeling of comfort changes between the individual and cultural groups (Goldstein, 1999).

c. Emotional Expression: Focal point of this approach is that expression of emotions in a comfortable manner during conflict process contributes to solution. Emotions are seen as energy which feeds conflict resolution as much as conflict itself (Bodtker ve Jameson, 2001). Most of the emotions can alleviate, prevent or control conflict.

d. Conflict approach/avoidance: In this approach, how individual comprehend the situation of conflict has a great importance. For some, it can end up with constructive and positive results; on the other hand, some others perceive it just the opposite and they keep away from conflict. However, it needs to be stated that good will and tolerance are indispensable to reach effective and long-lasting solution.

e. Self-disclosure: Individual's escape from the past experiences and steering his/her behaviors and attitudes without carrying prejudice and defensive emotions are important in conflict resolution process. Reaching results by this approach leads to constructive and positive results and helps individuals in making right decisions.

### Method

This research, which aimed both to study the interpersonal conflict solving approach preferences and to detect whether these preferences change according to their grade level and gender, was conducted in general scanning model. In this context, the research problems are:

1. What are the interpersonal conflict solving approach preferences of students?
2. Is there a significant level of change between the students' interpersonal conflict solving approach and grade levels?
3. Is there a significant level of change between the students' interpersonal conflict solving approach and genders?

### Sample

200 students from Mehmet Akif Ersoy University Faculty of Educational Science constitutes the sample of this research, which was conducted in 2009-2010 academic year fall term. Distribution of grades and gender of students are presented in Table 1.

Table 1. Student Level and Gender Distributions.

Gender	Grade			
	1. Grade	2. Grade	3. Grade	4. Grade
Female	45	45	19	15
Male	20	27	14	15
Total	65	72	33	30

### Data Collection Tool

Interpersonal Conflict Solving Scale was used as a data collection tool in this research. The originally named as **Conflict Communication Scale** and was developed by Goldstein (1999) was adapted to Turkish by Arslan (2005). The original scale had 75 items including sub-factors like confrontation, public/private behavior, emotional expression, approach/avoidance and self disclosure. Received high scores from each factor, respectively, shows that parties faced

more in the conflict processes, disclosed themselves, displayed emotional expression, demonstrated the general behavior and approached to conflict.

In their research, Basım, Çetin and Meydan (2009) examined the scale in terms of structure of validity; by preferring the best explaining items that describes scale factors, items whose factor loadings were under .40 were removed from the scale. Thus, by defining the items that best describes created model, the validity of the scale structure was attempted to enhance. Factor loadings of items for the final version of the 43 point scale change between .40 and .67, and 49, 34% of total variance can be explained by this model. Cronbach alpha reliability values of confrontation factor is .71, public/private behavior factor is .77, approach/avoidance factor is .78, self disclosure factor is .71 and emotional expression factor is .75. According to above data, it can be said that scale is valid and reliable. (Basım, Çetin ve Meydan, 2009). 43-item "Interpersonal Conflict Solving Scale" which was rearranged by Basım, Çetin and Meydan (2009) was used in this study. The scale was arranged in 7 likert type (1= Strongly Disagree, 7= Totally Agree).

### Data Analysis

This study was conducted primarily on descriptive statistical analysis regarding students' preferred approach to interpersonal conflict resolution. ANOVA statistical analysis was performed in order to test whether preferences of the students who participated in the study more than the grade level of interpersonal conflict resolution approaches differed significantly. To determine the grades between which the differentiation was detected, LSD comparison test (Least-significance difference) was applied. To determine whether some differentiation existed in Students about preferences on interpersonal conflict resolution approach according to their gender, t-test was applied for independent groups.

### Findings

The findings of the study are presented below with the scope of research problems.

1. How is the preferred approach of students on interpersonal conflict resolution?

The mean score of descriptive statistics on interpersonal conflict resolution related to public / private behavior, emotional expression, approach / avoidance and self-disclosure sub-factors of students are given in Table 2.

Table 2. Descriptive Statistics Results of the Students' Average Score Regarding Interpersonal Conflict Resolution

Interpersonal Conflict Resolution Approaches	N	Avg.	sd
Approach/Avoidance	200	3,640	,9944
Self-Disclosure	200	4,495	,8431
Public/Private Behavior	200	3,361	1,341
Confrontation	200	5,313	,8015
Emotional Expression	200	5,490	,9587

When the Table 2 is evaluated according to the scope of the first problem, interpersonal conflict resolution approaches of "emotional expression" sub-factor mean score (5.490) was the highest, "general behavior" sub factor mean score (3.361) was the lowest. In this context, it can be said that the students displayed more emotional expression of the conflict process, meanwhile they exhibited less overall behavior.

2. Is there a significant differentiation between the students according to their grade levels and their interpersonal conflict resolution approaches preferences?

Descriptive statistical results according to the students' prefer on interpersonal conflict resolution approaches with the grade level are presented in Table 3.

Table 3. Descriptive Statistics Results of Students' Interpersonal Conflict Resolution Approaches According to Grade Level Preferences.

Interpersonal Conflict Resolution Approaches	Grade	N	Avg.	Sd
Approach/Avoidance	1. Grade	65	3,401	1,001
	2. Grade	72	3,695	,988
	3. Grade	33	3,666	1,008
	4. Grade	30	3,997	,891
Self-Disclosure	1. Grade	65	4,423	,646
	2. Grade	72	4,390	,947
	3. Grade	33	4,636	,900
	4. Grade	30	4,744	,860
Public/Private Behavior	1. Grade	65	3,213	1,258
	2. Grade	72	3,581	1,333
	3. Grade	33	2,883	1,431
	4. Grade	30	3,681	1,303
Confrontation	1. Grade	65	5,317	,774
	2. Grade	72	5,398	,746
	3. Grade	33	5,107	,980
	4. Grade	30	5,329	,770
Emotional Expression	1. Grade	65	5,564	,935
	2. Grade	72	5,428	1,004
	3. Grade	33	5,519	,796
	4. Grade	30	5,442	1,085

ANOVA statistical analysis was performed in order to test whether the choice of students with interpersonal conflict resolution approaches differed significantly depending on grade level. Analysis indicated while average scores of students taken from "approach / avoidance" and "general behavior" sub-factors significantly differed according to grade level, "Self-Disclosure," "Confrontation" and "Emotional Expression" sub-factors average scores did not differentiate according to grade level. One of the most commonly used multiple comparison test Least-significance difference (LSD) (Bayram, 2004, p. 101) was applied to determine in which grade level differentiation has occurred. One factor ANOVA test results which students' average of scores compared according to the grade level are given in Table 4

Table 4. One Factor ANOVA Results Analysis Score Averages of Interpersonal Conflict Resolution Approaches According to Grade Level.

		Sum of Squares	df	Mean Square	F	p	Source of Difference
Approach/ Avoidance	Intergroup	7,770	3	2,590	2,685	,048*	A-D
	In-group	189,045	196	,965			
	Total	196,815	199				
Self-Disclosure	Intergroup	3,642	3	1,214	1,726	,163	
	In-group	137,835	196	,703			
	Total	141,476	199				
Public/Private Behavior	Intergroup	15,523	3	5,174	2,961	,033*	B-C
	In-group	342,514	196	1,748			C-D
	Total	358,037	199				
Confrontation	Intergroup	1,922	3	,641	,997	,395	
	In-group	125,941	196	,643			
	Total	127,863	199				
Emotional Expression	Intergroup	,731	3	,244	,262	,853	
	In-group	182,188	196	,930			
	Total	182,919	199				

(A: 1 Grade, B: 2. Grade, C: 3. Grade, D: 4. Grade), \*p<,05

When Table 4 is examined, it is observed that students' "approach / avoidance" point averages as differentiate statistically significantly according to grade level. Average scores for "approach/avoidance" were 3. 401, 3. 695, 3. 666, and 3. 997 for first, second, third, and fourth grade students, respectively. It is seen that the difference between first and fourth grades were in favor of the first grades in LSD analysis.

According to Table 4, it is observed that students' overall behavior points averages differentiated statistically significantly according to grade levels. The average "general behavior" scores were 3,213, 3,581, 2,883, and 3,681 for first, second, third, and fourth grade students, respectively. In LSD analysis it is seen that this differentiation was in favor of the second-grades among second and third grades and was in favor of fourth grades among third and fourth grades.

3. Is there a significant level of differentiation between the students' preferences of interpersonal conflict resolution approaches and the gender?

T-test was applied for independent groups to determine whether students interpersonal conflict resolution approach preferences differed according to gender participating in the study and the results are given in Table 5.

Table 5. T-Test Results for Independent Groups about Interpersonal Conflict Resolution Approaches according to Gender of Students.

Interpersonal Conflict Resolution Approaches	Gender	N	Avg.	S	df	t	p
Approach/Avoidance	Female	124	3,2991	,90893	198	-6,885	,000*
	Male	76	4,1974	,87315			
Self-Disclosure	Female	124	4,4722	,81719	198	-,487	,627
	Male	76	4,5322	,88821			
Public/Private Behavior	Female	124	3,0484	1,24698	198	-4,407	,000*
	Male	76	3,8722	1,34064			
Emotional Expression	Female	124	5,3754	,77209	198	1,391	,166
	Male	76	5,2135	,84303			
Emotional Expression	Female	124	5,5611	,90078	198	1,342	,181
	Male	76	5,3741	1,04223			

\*p&lt;,05

According to the analysis results given in Table 5, students' interpersonal conflict resolution approaches sub-factor of "self-disclosure", "face" and "emotional expression" average scores do not differ significantly according to gender. In addition, it is seen that there is significant differentiation in favor of male students compared to female students on "approach / avoidance" point averages ( $t_{198}=-6,885$ ,  $p<0,05$ ). Similarly, it is seen that there is a significant difference in favor of boys between male and female students' "general behavior" point averages ( $t_{198}=-4,407$ ,  $p<0,05$ ). According to the findings, male students "approach / avoidance" and "general behavior" score averages significantly differentiate according to female students, "self-disclosure", "face" and "emotional expression" average scores did not differ significantly according to gender.

## Conclusions

This study was conducted to explore the university students' interpersonal conflict resolution preferences and investigated whether the preferences differ or not according to a grade level and gender. Findings show that the students are generally preferring the emotional approach and the common approach is less preferable one in interpersonal conflicts. Emotionality can be considered as one of the positive and constructive approaches to conflict resolution. In this context, a sincere sadness can ease conflicts, prevent it, or can play an active role in the conflict resolution process in this respect. (Basım, Çetin ve Meydan, 2009)

Another result obtained from the research is that: while the expression point averages of university students on sub dimensions "Self-Disclosure", "Confrontation" and "Emotional Expression" do not differentiate significantly there seems to be a significant level of differentiation in "Approach / Avoidance" and "Public Private Behavior" sub dimensions at grade level. In the "Approach / Avoidance" sub-factor this differentiation is in favor of the fourth grades between the first and fourth grade students. In the "Public Private Behavior" sub-factor, differentiation is in favor of the second grades between the second and third grade students and in favor of the fourth grades between the third and fourth grade students.

"Approach/Avoidance" is how individuals approach to what they perceive as a general conflict and conflict resolution processes. While some of the people see conflicts natural, inevitable even in some cases as an opportunity for development and have positive perceptions to it, some of them discern such a situation should be avoided, as it is perceived negatively. Besides achieving effective and constructive solutions for conflict, not avoiding conflict; anticipates the approach to conflict. (Basim, Çetin ve Meydan, 2009)

In this respect, there seems that first grades prefer to avoid conflict more than fourth grade students. The reason of this situation might be due to the fourth grade students' longer period of education at the university. When the findings are evaluated in terms of gender; while the students "approach / avoidance" and "general behavior" mean scores differentiate significantly in favor of male students, the mean scores of "self-disclosure", "confrontation" and "emotional expression" do not differentiate meaningfully between male and female students. This result might be interpreted as while male students are adopting confrontation in conflict female students are avoiding from confrontation. The literature review revealed some studies with different results. It was stated that, while female employees avoid conflict in the business environment and exhibit cooperative attitudes in the home, males exhibit a more cooperative attitude in the work environment in the contrary (Chusmir ve Mills, 1989). In another study, it was stated that while females prefer avoidance approach, males prefer dominance approach in conflict resolution process. (Brewer etc. , 2002).

## References

- Arslan, C. (2005). *Investigating Interpersonal Conflict Solving and Problem Solving Approaches According to Their Attribution Complexity*. Unpublished PhD thesis, Konya Selçuk University Social Sciences Institutes.
- Barki, H. , & J. Hartwick. (2004), Conceptualizing the Construct of Interpersonal Conflict. *International Journal of Conflict Management*, 15 (3), 216-244.
- Basim, H. N. , Çetin, F. , & Meydan, C. H. , (2009). The Role Of Locus Of Control In Interpersonal Conflict Resolution Approaches. *Selçuk University Institute of Social Sciences Journal* 21, 57-69.
- Bayram, N. (2004). *Data Analysis with SPSS in the Social Sciences*. Bursa: Ezgi Bookstore.
- Bodtker, A. M. & Jameson, J. K. (2001). Emotion in conflict formation and its transformation: application to organizational conflict management. *International Journal of Conflict Management*, Vol. 12 (3): 259-276.
- Brewer, N. , Mitchell, & P. , Weber, N. (2002). Gender role, organizational status and conflict management styles. *International Journal of Conflict Management*, Vol. 13 (1): 78-94.
- Chusmir, L. H. & Mills, J. (1989). Gender differences in conflict resolution styles of managers: at work and at home. *Sex Roles Journal*, Vol. 20 (3-4): 149-163.
- Goldstein, S. B. (1999). Construction and validation of a conflict communication scale. *Journal of Applied Social Psychology*, Vol. 29 (9): 1803-1832.
- İpek, C. (2000). Organizational Conflict and Applicable Organizational Development Tools in Conflict Management, In C. Elma (Ed. ), *Contemporary Approaches to Management* (pp. 218-243). Ankara, Turkey.
- Janssen, O. & Vliert, E. V. (1996), Concern for the other's goals: key to de-escalation of conflict. *International Journal of Conflict Management*, 7, 2, 99-120.
- Koçel, Tamer. (2005). *Business Management* (10th ed. ). Istanbul, Arıkan Publication Release Distribution.
- Korkmaz, Sezer (1994), "Organizational Conflict Management and Efficiency", *Efficiency Journal*, 1994/1, Ankara, p. 77-94.
- Ma, Z. (2005, May). *Exploring cross-cultural differences in conflict management styles: a sino-canadian comparison*. D. Morin (Chair), Annual Conference of the Administrative Sciences Association of Canada, Toronto, 174-191.

- 
- Moore, Christopher W. (2003). *The Mediation Process: Practical Strategies for Resolving Conflict*, San Francisco, Jossey-Bass.
- Rahim, A. M. , & Bonoma, T. V. (1979). Managing Organizational Conflict: A Model for Diagnosis and Intervention. *Psychological Reports*, 44, 4, 1323-1344.
- Rahim, M. A. (2002). Toward A Theory of Managing Organizational Conflict. *International Journal of Conflict Management*. Vol. 13, Issue 3, 206-235.
- Shockley-Zalabak, P. (1988). Assessing the Hall Conflict Management Survey. *Management Communication Quarterly*, Vol. 1, No. 3, ss. 302-320.
- Sorenson R. L. , Morse E. A. , & Savage G. T. (1999). A Test of the Motivations Underlying Choice of Conflict Strategies In The Dual Concern Model. *International Journal of Conflict Management*, 10, 1, p. 25-44.
- Şahin, A. , Emini, F. T. , & Ünsal Ö. (2006), Conflict Management Methods and Application in the Hospital Organization. *Selçuk University Institute of Social Sciences Journal*, s. 15/2006 p. 553-568.

---

## Spatial Analysis of Adults Involvement in Education in Poland

Alicja Grześkowiak

Wroclaw University of Economics

alicja.grzeskowiak@ue.wroc.pl

### Abstract

*Knowledge and competences play an important role in the development of the knowledge-based economy. Therefore, the idea of lifelong learning is a crucial element of development strategies. Various forms of learning may be distinguished, e. g. according to ISCED methodology formal, non-formal, informal and random ones. The participation rates in educational activities differ from country to country. Comparative analyses show that an unfavorable situation in this field can be observed in Poland. Despite many incentives and opportunities for continuous education, the percentage of people participating in trainings is one of the lowest in Europe. A vital question arises whether this issue shows spatial relationships when lower-level (regional) data are taken into consideration. The purpose of this paper is to determine if the educational processes in Poland show regional similarities or dissimilarities. The analysis is performed on the basis of variables characterizing lifelong learning activities at the regional level. Statistical methods taking into account the spatial position of the units are used in order to evaluate spatial relations.*

**Keywords:** adult education, lifelong learning, spatial analysis

### 1. Introduction

One of the crucial elements of the knowledge-based economy is the necessity of continuous improvement of skills, competences and knowledge. Lifelong learning process is not very well developed in Poland as compared to many other European countries. Recent researches depicting the situation (Czapiński & Panek 2013; Grześkowiak 2013; Grześkowiak 2014; Grześkowiak 2015; GUS, 2009) indicate that there are various socio-economic factors associated with the involvement in lifelong learning activities. This paper is focused on another aspect, namely spatial distribution of the participation. Poland is divided into sixteen *NUTS 2* regions called voivodeships and this division is used to analyze spatial relationships. The main objectives of the study are:

- the evaluation of the spatial differentiation of the adults' participation in education,
- the assessment of the regional convergence with regard to the adults' participation in education,
- the detection of spatial patterns of the adults' participation in education.

Chosen spatial data analysis methods as well as some visualization techniques are applied to assess these issues.

### 2. Data and methods description

This research is carried out on the basis of several variables characterizing adults' involvement in education in Poland at the regional level. The data come from various sources: Eurostat and Polish nationwide surveys on human capital (*Bilans Kapitału Ludzkiego*). Eurostat presents *Participation rate in education and training (last 4 weeks) by NUTS 2 regions within Labour Force Survey*. This indicator calculated for persons aged 25-64 is used to compare the implementation of the lifelong learning strategic educational objective across European Union countries. The data on it are available from 2001 until 2013 and therefore such a period is included in the analysis. The other data source allows a more comprehensive insight into the educational processes, but for a shorter period of time from 2010 to 2013. The survey on human capital concerns individuals in productive age (i. e. 18-64 for men and 18-59 for women) and includes questions on educational activities in various forms: the formal education, the training and the self-study. In this paper, participation in trainings is treated as a proxy of non-formal education and self-education activities as a proxy of informal education. The participation in the formal education is assessed on the basis of the question whether the respondent is currently taking part in it. The participation in the non-formal and the informal education relates to a declaration for the last 12 months.



Various analytical methods and visualization techniques are applied to assess the spatial differentiation of adults educational involvement. Choropleth maps are used to present the overall situation. The relations and changes of the participation rates in various forms of continuous education are depicted by a graphical presentation named parallel coordinates (see Inselberg, 1995) available by the *parcoord* from *MASS* R package (Venables & Ripley, 2002; Wegman, 1990). The degree of regional diversity in *Participation rate in education and training* indicator is assessed by the coefficient of variation (CV) and its nonparametric analogy (the interquartile range divided by 2 times median). The regional convergence of lifelong learning participation is evaluated by the analogy with the approach used in the growth studies in which the process of reducing the differences between regions is examined. Two concepts of convergence are frequently considered: beta and sigma convergence (Barro et al, 1991; Sala-i-Martin, 1996). Sigma convergence may be evaluated by the changes of the coefficients of variation (see Trojak & Tokarski, 2013, p. 29).

The further part of this paper deals with spatial autocorrelation (association) meaning "the correlation among observations of a single variable ( . . . ) strictly attributable to the proximity of those observations in geographic space" (Fisher & Wang, 2011, p. 22). Moran's I statistic is applied as a global measure of spatial differentiation (Kopczewska, 2011, p. 72):

$$I = \frac{\sum_i \sum_j w_{ij} (x_i - \bar{x})(x_j - \bar{x})}{S^2 \sum_i \sum_j w_{ij}}$$

and

$$s^2 = \frac{1}{n} \sum_i (x_i - \bar{x})^2$$

where:  $x_i$  - observation in region  $i$ ,  $\bar{x}$  - mean calculated for all regions,  $n$  - number of regions,  $w_{ij}$  - element of spatial weights matrix.

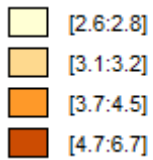
There are various methods of determining the spatial weights and in this paper rook-based first order contiguity approach is used (see Anselin 2004, pp. 106-110). The spatial autocorrelation patterns are visualized by Moran's scatterplot (see Anselin, 1996). Local indicators of spatial association (LISA) are used as a tool for the decomposition of Moran's I statistic and allowing to evaluate the contribution of each region (Anselin, 1995). LISA cluster maps are applied to illustrate significant regions (see Anselin 2004, pp. 140-141).

The analysis are performed with application of R and GeoDa programmes.

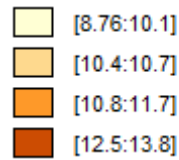
### 3. Spatial differentiation of lifelong learning participation in Poland

The distributions of various forms of the lifelong learning process may be compared by the choropleth quartile maps. The situation in 2013 (most recent data) is reflected in Figure 1. The arrangement of colours shows that there are some spatial differences of adult involvement in the educational process. However, patterns vary depending on the form of education.

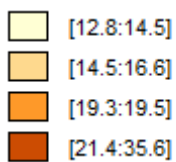
**Education and training (LFS) 2013**



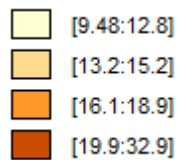
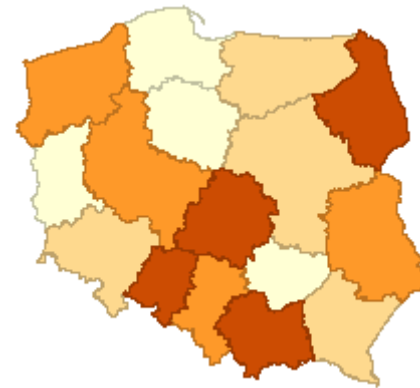
**Formal 2013**



**Non-formal 2013**



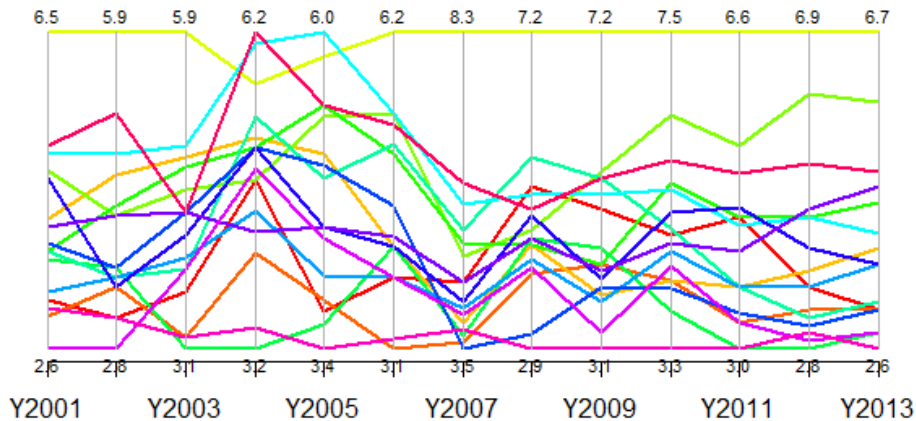
**Informal 2013**



**Figure 1.** Spatial distribution of participation in educational activities in 2013 by quartiles

Source: own elaboration based on LFS Eurostat data

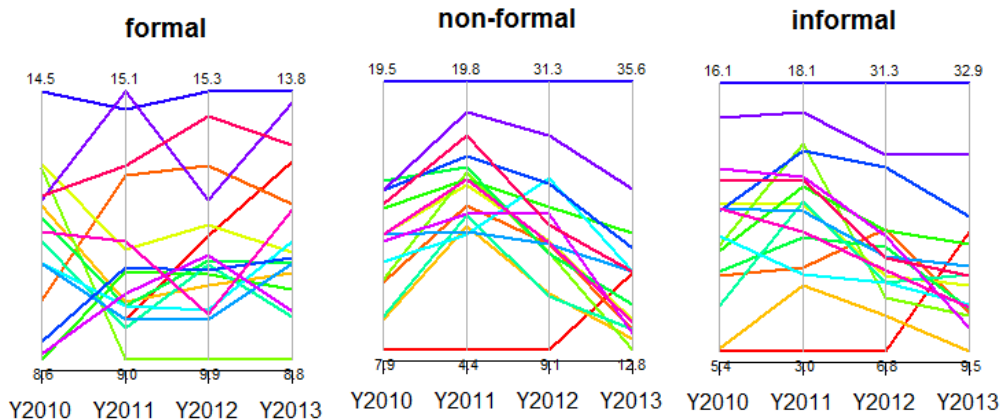
Although the choropleth map presentation is very clear and interesting, its application is a bit limited in the case of longer time series. Hence, a visualization called parallel coordinates is applied in order to compare the course of the phenomena (Figure 2, Figure 3).



**Figure 2.** Parallel coordinates presentation of the participation rate in education and training in Polish regions in years 2001-2013

Source: own elaboration based on LFS Eurostat data

The course of the lines on the graphs indicate that the participation in various forms of education differs from region to region. In some regions, a constant low or constant high level is observed. However, in most regions, the variability of the participation rate is substantial. Spatial patterns are different for various forms of education.

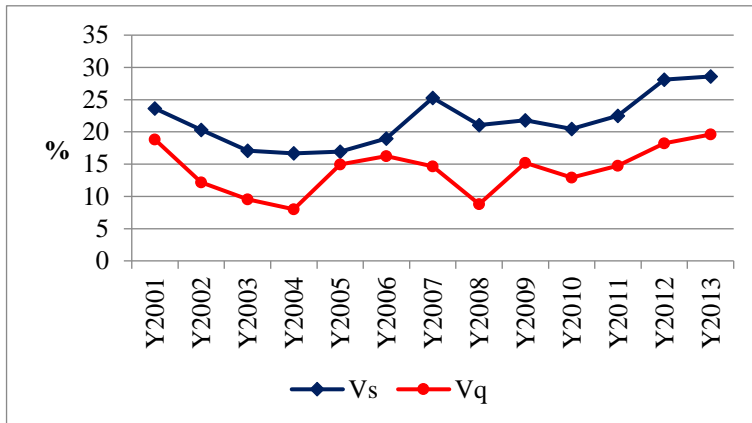


**Figure 3.** Parallel coordinates presentation of the participation in various forms of education in Polish regions in years 2010-2013

Source: own elaboration based on Bilans Kapitału Ludzkiego 2010-2013 data

The variability is assessed by the coefficients of variation compared with the critical value equal to 10%. Assuming this critical value it can be stated that the participation in education and training is characterized by significant regional differences. The coefficients of variation are also the basis for evaluating the degree of the regional convergence.

Decreasing values would indicate a diminishing divergence between regions. Figure 4 shows the evolution of the coefficients of variation in the years 2001-2013. Their values do not allow to draw the conclusion that there is the sigma convergence of the Polish regions in the field of lifelong learning. Moreover, the increasing variability since 2010 suggests the divergence in this area.



**Figure 4.** Coefficients of variation ( $V_s$ ) and their nonparametric analogies ( $V_q$ ) calculated for the participation rate in education and training in Polish regions in years 2001-2013

Source: own computations based on Eurostat LFS data

The time series relating to various forms of training include only four years. Such a small number of observations is not sufficient to infer about the convergence.

#### 4. Evaluation of spatial autocorrelation

The presence of the spatial autocorrelation of the participation in education and training in the global sense is verified by Moran's I statistics (Table 1). All Moran's statistics values are below zero, demonstrating a negative autocorrelation, but pseudo p-values indicate that the dependences are not significant.

**Table 1.** Evaluation of the global spatial autocorrelation of participation in education and training

Year	Moran's I statistic	p-value*
2001	-0,0283	0,3586
2002	-0,1556	0,3057
2003	-0,2185	0,1538
2004	-0,1058	0,4320
2005	-0,2987	0,0590
2006	-0,2424	0,1259
2007	-0,2205	0,1079
2008	-0,1020	0,4316
2009	-0,1603	0,2727
2010	-0,2115	0,1479

2011	-0,1802	0,2248
2012	-0,2364	0,1219
2013	-0,2388	0,1109

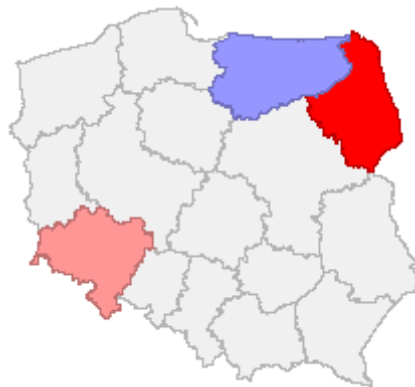
Note: \*pseudolevel calculated by a random permutation algorithm (number of permutations =1000)

Source: own computations based on LFS Eurostat data

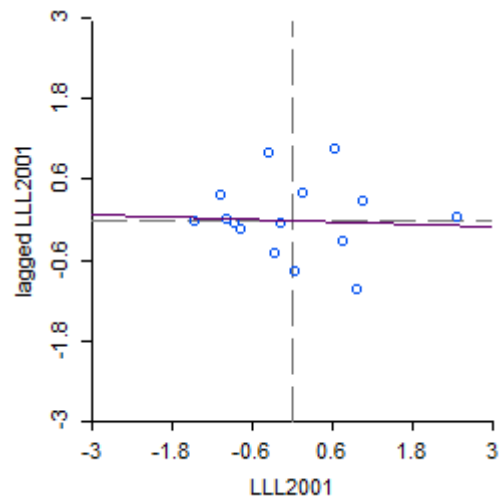
The detailed analysis using LISA reveals locations with significant local Moran statistics. LISA cluster maps and Moran's scatterplots for years 2001 and 2013 are presented in Figure 5. There were three regions with significant local Moran statistics in 2001, each with different characteristics. The Podlaskie voivodeship was characterized by a high participation rate as well as its neighbors. The involvement in education and training was substantially higher in the dolnośląskie voivodeship as compared to the neighboring regions. Poor engagement was observed in warmińsko-mazurskie voivodeship in relation to the contiguous regions. In 2013, the local Moran statistic was significant only in the case of the warmińsko-mazurskie voivodeship, where participation in lifelong learning was again essentially lower than in the neighboring provinces.

### Education and training (LFS) 2001

#### LISA Cluster Map



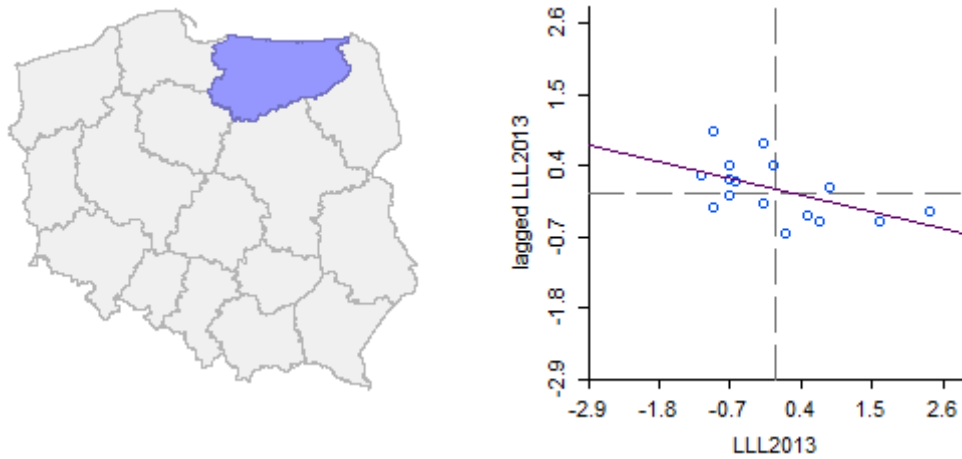
#### Moran's scatterplot



### Education and training (LFS) 2013

#### LISA Cluster Map

#### Moran's scatterplot



**Figure 5.** LISA cluster maps and Moran's scatter plots concerning the participation in education and training in 2001 and 2013

Source: own elaboration based on LFS Eurostat data

The spatial autocorrelation of various forms of education is also considered. The values of the global Moran's statistics and pseudo p-values are shown in Table 2. Certain regularities may be noticed. A positive spatial autocorrelation occurs for the participation in the formal education in all years. The voivodeships with the high rates tend to be close to one another. The same holds for the voivodeships with the low rates. There is no spatial autocorrelation of informal learning. The only significant dependence for non-formal learning is observed in 2011.

**Table 2.** Evaluation of the global spatial autocorrelation of participation in various forms of education

Form	Year	Moran's I statistic	p-value*
formal	2010	0,2765	0,0190
	2011	0,4284	0,0040
	2012	0,2361	0,0420
	2013	0,2458	0,0320
non-formal	2010	0,0545	0,1909
	2011	0,1995	0,0320
	2012	-0,1237	0,3676
	2013	-0,0168	0,3427
informal	2010	-0,0422	0,4296
	2011	-0,1228	0,3786

2012	-0,0522	0,4286
2013	-0,0619	0,4396

Note: \*pseudolevel calculated by a random permutation algorithm (number of permutations =1000)

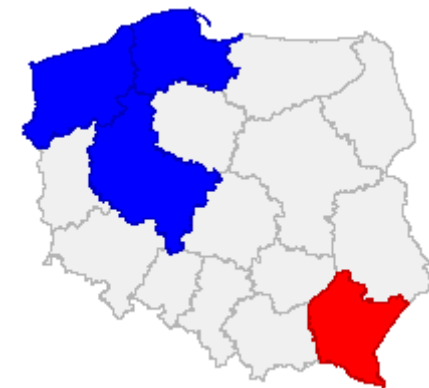
Source: own computations based on Bilans Kapitału Ludzkiego 2010-2013 data

Some interesting detailed results are obtained by the application of LISA and presented on the cluster maps in Figure 6 and Figure 7.

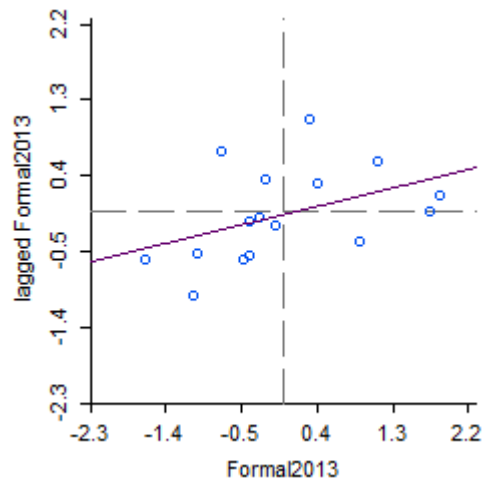
There are four regions characterized by a significant local Moran's statistics in 2013 if the participation in formal learning is taken into account. Three of them, i. e. the zachodniopomorskie, the pomorskie and the wielkopolskie voivodeships have a low level of the educational engagement and the same regularities are present in the contiguous regions. The opposite situation is observed in the podkarpackie voivodeship where the high participation rate is accompanied by the high involvement in the neighboring provinces.

### Formal 2013

#### LISA Cluster Map



#### Moran's scatterplot

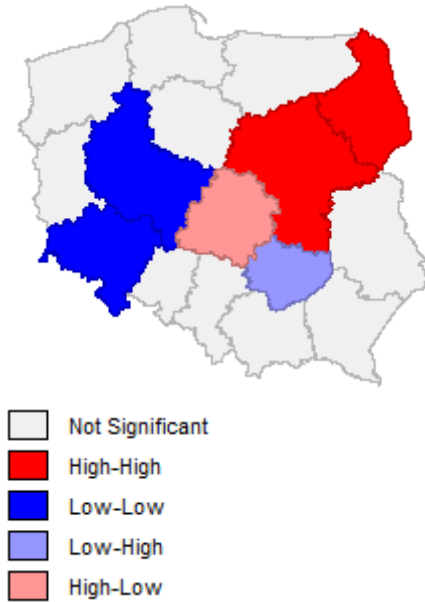


**Figure 6.** LISA cluster map and Moran's scatter plot for formal education participation in 2013

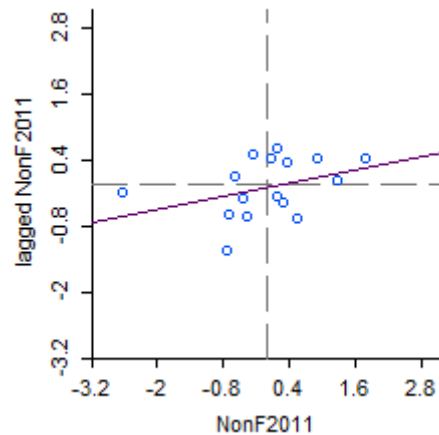
Source: own elaboration based on Bilans Kapitału Ludzkiego 2011 and 2013 data

## Non-formal 2011

## LISA Cluster Map



## Moran's scatterplot



**Figure 7.** LISA cluster map and Moran's scatter plot for non-formal education participation in 2011

Source: own elaboration based on Bilans Kapitału Ludzkiego 2011 and 2013 data

Six regions are distinguished if the spatial distribution of the participation in non-formal education in 2011 is evaluated by the local Moran's statistics. All types of spatial dependences are represented: high values in the regions and high values in the neighboring regions (podlaskie and mazowieckie voivodeships), low values in the regions and low values in the neighboring regions (dolnośląskie and wielkopolskie voivodeships), high value in the region and low values in the neighboring regions (łódzkie), low value in the region and high values in neighboring regions (świętokrzyskie).

## 5. Conclusions

There is a spatial differentiation in terms of the adults' activities in the field of the continuous education in Poland. The levels of participation rates vary across regions. In recent years, there was no evidence of regional sigma convergence in this aspect. Spatial autocorrelation was detected in some cases. A distinct positive relationship was found in the case of participation in formal education in years 2010-2013. Regions of high and low degree of adults' involvement in this form of education tend to form clusters. The spatial dependencies for the other forms of lifelong learning are not significant in the sense of spatial autocorrelation with the exception of non-formal education in 2011.

## References:

Anselin, L. (1995). Local indicators of spatial association-LISA. *Geographical analysis*, 27 (2), pp. 93-115.



- Anselin, L. (1996). The Moran scatterplot as an ESDA tool to assess local instability in spatial association. *Spatial analytical perspectives on GIS*, 111, pp. 111-125.
- Anselin, L. (2004). *Exploring spatial data with GeoDaTM: a workbook*. Urbana, 51, 61801.
- Barro, R. J. , Sala-i-Martin, X. , Blanchard, O. J. , & Hall, R. E. (1991). Convergence across states and regions. *Brookings papers on economic activity*, pp. 107-182.
- Czapiński, J. & Panek, T. (eds. ). (2013). Social diagnosis 2013. Objective and subjective quality of life in Poland. *Diagnoza Społeczna 2013. Warunki i Jakość Życia Polaków, Contemporary Economics*, Vol. 7, pp. 1-491.
- Fischer, M. M. , & Wang, J. (2011). *Spatial data analysis: models, methods and techniques*. Springer Science & Business Media.
- Grześkowiak, A. (2013). Statystyczna analiza aktywności edukacyjnej osób dorosłych w Polsce, *Ekonometria*, 2 (40), pp. 22-35.
- Grześkowiak, A. (2014). Self-learning as a method of improving skills by adult Poles - evidence from non-metric survey data, [in: ] *Proceedings of the 12th International Academic Conference*, IISES, Prague, pp. 486-495.
- Grześkowiak, A. (2015). Wielowymiarowa analiza uwarunkowań zaangażowania Polaków w kształcenie ustawiczne o charakterze pozaformalnym. *Prace Naukowe Uniwersytetu Ekonomicznego we Wrocławiu* (forthcoming).
- GUS. (2009). *Kształcenie dorosłych*. Warszawa.
- Inselberg, A. (1985). The plane with parallel coordinates, *The Visual Computer*, 1. 2, pp. 69-91.
- Kopczewska, K. (2011). *Ekonometria i statystyka przestrzenna z wykorzystaniem programu R CRAN*. Warszawa: CeDeWu Wydawnictwa Fachowe.
- Sala-i-Martin, X. X. (1996). The classical approach to convergence analysis. *The economic journal*, pp. 1019-1036.
- Trojak, M. , Tokarski, T. (eds. ). (2013). *Statystyczna analiza przestrzennego zróżnicowania rozwoju ekonomicznego i społecznego Polski*. Kraków: Wydawnictwo Uniwersytetu Jagiellońskiego.
- Venables, W. N. & Ripley, B. D. (2002). *Modern Applied Statistics with S*. Fourth edition. Springer.
- Wegman, E. J. (1990). Hyperdimensional data analysis using parallel coordinates. *Journal of the American Statistical Association* 85, pp. 664–675.

---

## The SME in a Globalized Economy. Challenges of the Albania's SME in the Optic of Small Business Act

Eralda Xhafka

<sup>1</sup>Department of Production and Management,  
Faculty of Mechanical Engineering, Albania, [exhafka@fim.edu.al](mailto:exhafka@fim.edu.al)

Elidon Avrami

<sup>2</sup> Bank branch manager, [eavrami@yahoo.com](mailto:eavrami@yahoo.com)

### Abstract

*In the context of globalization, SMEs tends to consolidate and the question of how SMEs manage the competition is intriguing. Besides larger competitors with visible, physical premises, other processes related to globalization are presenting SMEs with both opportunities and threats. The next 5 years are an important benchmark for a number of EU political processes that indirectly effect the well-being of the SME's. SBA is a bright idea how to follow-up and reinvigorate the Lisbon Strategy so that the continuing efforts of Entrepreneurs are focused on the real reforms that they desperately need to implement. All SME face rigid labor markets that keep a large part of the work-force outside the labor market. They have tax systems that not only discourage innovation and creativity but also actually destroy incentives and risk-taking. Entrepreneurs need secure and stable rules. Otherwise they might become disillusioned about the European project as a whole. They know that closer integration can give them increased competitiveness, growth and jobs. They must therefore be able to continue to believe in Europe as their natural platform for trade and investment. The Small Business Act, launched by the European Commission, identifies the right priorities to unleash the potential of the SME. This paper analysis the characteristic of the Albania SMEs, advantages and disadvantages in relation to Globalization and present the solution of the ten principles of SBA as a way forward to improve their performance.*

**Keywords:** Globalization, SME, Small Business Act, European Commission, Albania

### 1. The Small Medium Enterprises in a globalized economy

The importance of SMEs lies in the key role they have in the growth of the states (Feeney and Riding, 1997), the large number of people who rely directly or indirectly on them (Fida, 2008), the contribution they have in achieving certain socio-economic objectives, including poverty reduction (Cook and Nixon, 2000).

Peter Drucker asserted in respect of SMEs that "small businesses represent the main catalyst of economic growth". Entrepreneurship, flexibility and responsiveness to change are attributes of SMEs and are real driving forces of economic development. We can also say that SMEs contribute largely to the increasing standard of living and prosperity. The main reasons of this paper for the impact of the SME in the economic growth are connected with the following factors:

- SME are the 99 % of the active enterprises
- Turnover of SMEs constitute about 71% of the total
- SMEs provide the majority of employment
- SMEs are the most dynamic enterprises

Micro, small and medium-sized enterprises (SMEs) represent an overwhelming proportion of the entrepreneurial structure of the EU. They contribute in large measure to the economic growth, job creation and innovation (essential

---

for the competitiveness of European companies). In the European Union about 20,70 millions of small and medium-sized enterprises (SMEs) ensure around 2/3 of the jobs in the private sector and represent 99,80% of the total enterprises<sup>1</sup>.

Small and medium enterprises contribute raising the living standards of society by stimulating the economic activity, the diversity of products offered to consumers and creating new jobs.

According Graham Bannock (2005) small and medium enterprises have always played a very important role in economic and social life of any country, being the basis of the development of the economy. Dynamism, flexibility, adaptability, mobility and their innovative potential are considered to be essential for the harmonious development of the economy of any Member State, and may ensure the cohesion of the economic structure, good economic growth and, of course, creation of new jobs.

The globalization process for SMEs can be realized through cross border activities, including trade, international investment, and participation in strategic alliances, partnerships and networking arrangements. The globalization of business has increasingly drawn SMEs, especially those in sectors subject to strong globalization forces, into global value chains through different types of cross-border activities. There is evidence that a group of SMEs with high-growth potential require early access to international markets to ensure their development and growth. Generally SMEs evidence suggests that the contribution they make to local and national economies remain underrepresented in the international economy but this situation is changing.

Those SMEs which are internationally active tend to be larger than the average SME. The average SME employs less than 10 people, whereas the bulk of SME exports and international investment comes from SMEs which employ more than 50 or 100 employees. Most net job creation and wealth creation seems to come from either fast growth firms or from net startups and large firms are net destroyers of jobs. Therefore, only if the globalized economy is conducive to the startup and growth of entrepreneurial SMEs then the process of globalization will be seen as a positive force of net job.

It is suggested that to a number of factors such as rapid changes in ICT and access to the worldwide web which appear to make it easier for SMEs to move across borders, are added other factors at play which may be contributing to impede SME access to the global economy. Another factor that continue to hurdle the SMEs contribution to the global economy is the complexity and differences in the regulatory systems and business environment between countries. The success and growth of international SMEs will be enhanced by a more internationalized infrastructure oriented to the smooth growth of firms across borders. This have to be applied to the infrastructure for financial markets, advisory services, information access, telecommunications, intellectual property rights markets and regulation, dispute resolution processes, etc. they all need to be internationalized. All of this requires active collaboration between governments, international agencies and the private sector to address these issues with the view of reaping the significant potential benefits that should accrue from the creation of a simpler, more business friendly, and more integrated economy at international levels.

This paper highlights the need for a more comprehensive approach to SME development in Albania, combining on going reforms to improve the general business environment with targeted interventions to support specific segments of the enterprise population, such as innovative enterprises, start-ups or export oriented enterprises.

The recommendations of this article go to the government action to create a level playing field for all SMEs, through the regulatory reform and administrative simplification, as well as investments in human resources, provision for better services in business development, better access to finance and stimulating the technological transfer.

## **2. The Characteristics and the obstacles in the international performance of SME**

### **2.1. Features of SMEs**

The concept of the SME seems at first glance to be a clear notion. However, after following a review of the literature, it reveals that researchers do not agree on a single definition of SMEs. Diversity is reflected also in the market occupied by SMEs, making a distinction between SMEs activating in the field of artisanal and those working in high-tech sectors. The

---

<sup>1</sup> EU SMEs in 2012: at the crossroads Annual report on small and medium-sized enterprises in the EU, 2011/12

legal status of SMEs is also very diverse. SMEs can be incorporated as limited liability partnerships, stock companies and limited liability companies. In a single market such as the European Union, where there are no internal borders, it is clear that measures to encourage SMEs should be based on a common definition, in order to increase their efficiency, for comparability of data released and in order to limit distortions. This is absolutely necessary due to the alignment of national measures with those required by the European Union to support SMEs in areas such as regional development and finding funds. The current definition is contained in the Recommendation No. 2003/361/EC which was adopted by the European Commission on 6 May 2003. In accordance with that recommendation, the classification of SMEs is based on staff levels, turnover or total balance sheet. According to EU definition, SMEs are made of firms that employ less than 250 people and that have an annual turnover of no more than 50 million Euros and/or a total balance sheet that does not exceed 40 million Euros. The identification of SMEs in Albania is regulated by law (Law Nr. 1042, dated 22. 12. 2008). According to this law, the identification of small and medium enterprises is made by taking into consideration the number of employees and annual turnover or balance sheets of their assets. These indicators for each category are defined as below.

**Table 1.** SME Definition according Albanian Legislation

	<b>No. of employees</b>	<b>Annual Turnover or Balance Sheet</b>
<b>Micro enterprises</b>	0 to 9 persons	<b>0 -10 million ALL</b>
<b>Small enterprises</b>	10 to 49 persons	<b>50 million ALL</b>
<b>Medium enterprises</b>	50 to 249 persons	<b>250 million ALL</b>

**Source:** Adapted from Albanian Legislation (Law Nr. 1042, dated 22. 12. 2008)

Another distinct difference between Albania and the EU is the importance of the different SME size categories. The services and trades sectors are dominated by micro-enterprises, while industry and construction sectors are dominated by medium enterprises. In 2012, about 90. 2 percent of enterprises were with 1-4 employed. The most part, 67%, have only 1 self-employer<sup>1</sup>. Therefore we can say that the structure of enterprises in Albania is based on micro enterprises.

An important aspect of the development of Albanian economy is the size of the companies operating in the market. As it has been shown by the past and current studies, the main percentage of the companies operating in the Albanian market are micro firms, small and medium enterprises, with only a number of companies, which can be categorized as large companies.

During 2010 - 2012, around 95% of these employees work in micro enterprises. According to Albanian Ministry of Economy during the period of 2008-2020 the contribution of SME sector was 73% of GDP. As a result, it can be said that the SME sector continues to play an important role in the economy of the country. Unfortunately, the companies operating in this sector are the ones that face the most challenges and obstacles during their daily operation.

The share contribution of agriculture sector is 21% of GDP in 2010. The rest of GDP, is covered by industry approximately 20% and 59% services. During the three years 2009-2011, the Albanian economy was increased with an average estimated at 3. 4% of GDP, inflation 2 - 4%. Unemployment rate has shown decline, reaching 13. 3% from 13. 5% in 2010. Exports of goods increased by 23%.

<sup>1</sup> INSTAT 2012, Business Register 2012

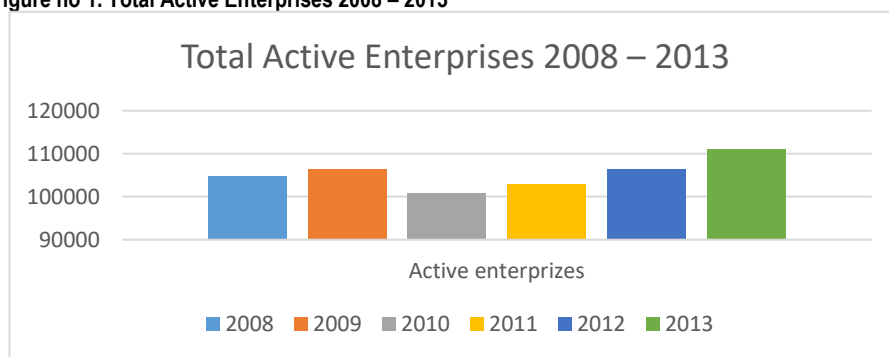
Number of active economic enterprises in 2013 was 111. 083, which increased 4,41percent compared with 2012. By economic activity, enterprises that operate in trade sector comprise 43. 3 percent, while enterprises with 1-4 employed are those which prevail with 89. 4 percent where services producers dominate with 78. 9 percent.

**Table 2.** Total Active Enterprises 2008 – 2013

	2008	2009	2010	2011	2012	2013
Active enterprises	104750	106477	100687	103038	106387	111083

**Source:** Adapted from INSTAT Albania, Business Register 2013

**Figure no 1.** Total Active Enterprises 2008 – 2013



**Source:** Adapted from INSTAT Albania, Business Register 2013

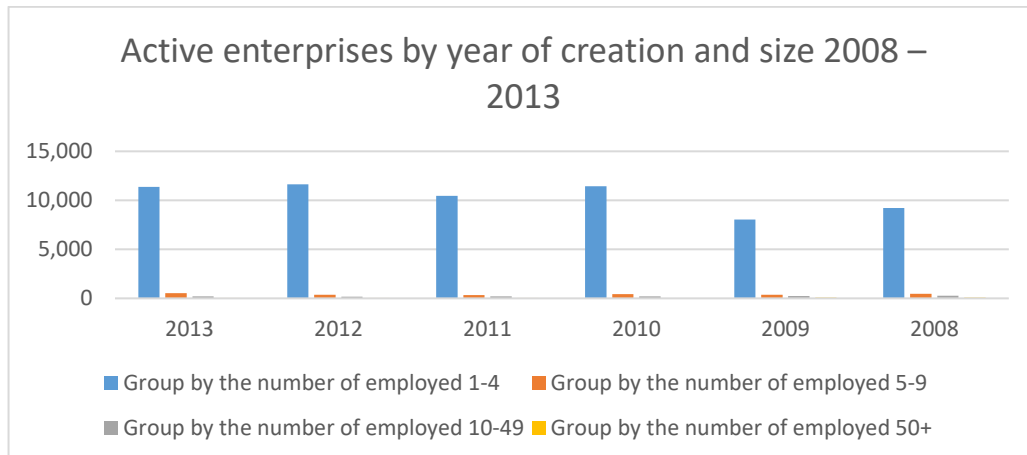
In 2013 the number of new enterprises is 12,131 while in 2012 it was 12,248, 36. 9 % of new enterprises carry out trade economic activity. In trade group "wholesale trade, except of motor vehicles and motorcycles" dominate by 72. 5 %;

**Table 3.** Active enterprises by year of creation and size 2008 – 2013

Year of Creation	Total	Group by the number of employed			
		1-4	5-9	10-49	50+
<b>Total</b>	<b>66. 198</b>	<b>62. 139</b>	<b>2. 507</b>	<b>1. 271</b>	<b>281</b>
2013	12. 131	11. 358	539	196	38
2012	12. 248	11. 644	369	183	52
2011	11. 033	10. 458	349	190	36
2010	12. 091	11. 436	430	193	32
2009	8. 685	8. 032	365	225	63
2008	10. 010	9. 211	455	284	60

Source: Adapted from INSTAT Albania, Business Register 2013

Figure no 2. Total Active Enterprises 2008 – 2013



Source: Adapted from INSTAT Albania, Business Register 2013

Among other specific characteristics of SMEs there is identified the vulnerability to losing customers. Furthermore, SMEs are usually reluctant to adopt regulations and are less sensitive to institutional pressures as large companies are (H. Jenkins, 2004).

## 2.2. The Limitations of SME access to international markets

In addition to opportunities, globalization can also pose challenges and threats for SMEs which from a resource viewpoint, are less well-equipped than larger firms to confront. These challenges can expose them to heightened international competition from foreign firms, and may result in the loss of traditional markets to lower-priced competition from overseas. Challenges and threats can concern the following: standards and international compatibility issues; intellectual property protection; political risks, corruption; and rule of law issues.

To date, there has been little research undertaken to quantify the amplitude of impediments to SME globalization or their economic impact, for either OECD member countries or non-member economies. While a majority of SMEs have the vocation to serve only local markets, a significant share of enterprises need to access foreign markets to ensure their survival and expansion, among which is a group of high-growth, export-oriented enterprises (OECD, 2002). Many of the barriers that SMEs can face originate at the level of the national economy, institutions, and general infrastructure. Competition policy, legislative and regulatory frameworks, telecommunications infrastructure, research and education policy contribute to SME preparedness for globalization. In particular, barriers can concern intellectual property rights; political risks; corruption and rule of law issues. They can relate to the entire range of business operations, having implications for business and organization models, managerial and technological capability; and innovative capacity. As mentioned earlier, SMEs are less well-equipped than larger firms to address these difficulties.

Owners of SMEs, more often, identify the business environment factors as factors hindering the development of their activity. Shortages and supply disruptions of the electric energy is the most important factor that inhibits the activity of SMEs.

The second factor that prevents SMEs is the unclear fiscal legislation and its incorrect implementation.

Also the consumer demand factor, is a barrier for SMEs in Albania. In terms of material supply, it is noted that the competition with the imports production, is identified as a limiting factor for the development of SME business. In the construction sector, the main obstacles for SMEs are dishonest way to implement the fiscal legislation and the procurement. Difficulties in obtaining credit and financial liquidity problems are also important for the development of SME in the building sector. The fear of an insufficient profit is the most important factor that limits the future planning of investments for SMEs. While profit is the only tool for investment in the SME sector, such results shows that during the future years the benefit of SMEs is to slow down.

One of the main challenges faced by the Albanian SME is the financing. Even though in the last years the burden of obtaining external financing, mainly bank/financial institution loan, has been reduced, yet the Albanian SME continue to be very concerned by the long, difficult and very bureaucratic administrative aspect of the lending procedures. The main problem that concerns SMEs is the collateral since the conditions required to be met by the collateral to be considered as good and acceptable collateral are heavy for SMEs. Usually, banks require that collateral is either in the form of a real estate property, or collateral may be in the form of a bank deposit. Therefore, being that most of the Albanian SMEs can hardly reach reasonable profit margin, let alone make enough profit to own various properties and bank deposits to act as collateral for a bank loan, in most of the cases many excellent business ideas do not become true due to the lack of collateral. Moreover, The Albanian SMEs find the amount of forms required to be filled in by them very excessive and time wasting.

Nevertheless, in contrast to the European SMEs, the Albanian SMEs do not have any external assistance while filling them in or to make these procedures easier for them. Additionally, the high interest rates offered by the banks are another problem encountered by the Albanian SMEs. Even though, the degree of competitiveness between the banks operating in the banking sector have increased in the last few years, yet the interest rates have not experienced a substantially decrease Infrastructure has always been, and it continues to be a big problem for the normal development of the Albanian economy. Even though, in the last years, the infrastructure has undergone major improvements, still there are many problems with it. One of the main problems of the infrastructure worth to be mentioned is that, nowadays the rail system in Albania is badly damaged and its usage level is very small due to the lack of necessary investments. Usually, railway network is used for people transportation and not for goods transportation and as a result, nowadays the only method of transporting the commercial goods is by using the road system making the transportation process very long and expensive for SMEs.

Albania as the rest of Europe has understood the importance of the entrepreneurship in the further development of the national economy. Nevertheless, Albania in contrast to other countries in the region of Western Balkans has done little to develop the entrepreneurial attitude. Over the last years, the Albanian state has introduced entrepreneurship as a module in various educational levels with a more an academic approach of it where its basic concepts are explained. Nonetheless, the module is not taught continuously and following a logical increasing level of knowledge throughout an educational level, but it experiences gaps and the taught things may be repeated at various levels. As a result, the Albanian youngsters are not ready yet to face the challenges that comprise being an entrepreneur when they finish studies.

Even though, Albania has undertaken various measures to develop the innovation spirit among the enterprises, innovation still is not at the desired levels. Online services such as e-business and e-signature, which are commonly used in EU, in Albania exist merely as a concept and are not widely used by Albanians. The main reason for this lack of usage is that Albania does not have a proper developed infrastructure for online services. Another problem

related to innovation is that Albanian enterprises do not focus as much as they should on R&D. Usually, the Albanian enterprises focus more on increasing their profit forgetting that successful R&D ideas will help them generate more profit.

### **3. Challenges of Albanian's SME in the optic of Small Business Act**

#### **3.1. SMEs in the Albanian economy – Key indicators**

Since the place occupied by the SME-s in the Albanian market resemble that of the EU market, then it is vital for Albania to give to them the same importance and pay the same attention that it is given to the SME-s in the EU. As it can be seen, the challenges faced by the SME-s in the European Union are the same challenges faced by the SME-s in Albania. Although the Albanian economy is still an emerging economy, the severity of these challenges is higher and the measures to be undertaken should be greater.

The role of SME in the Albanian economic growth has been quite satisfactory. In particular, the progress has been more important in the construction and transport sectors. The Small and medium enterprises that operates in the industry and construction sector are the main contributors to employment growth compared to other sectors of non-agricultural. Albania is a very attractive market for the foreign investors because the country possesses the very favorable geographic position of Albania and the rich natural resources and very skilled and at low cost human resources Albania is an economy dominated by services.

There exist many important challenges to be faced by Albania in order to achieve the desired levels of economic development and become a very competitive in the regional and global market. The major part of the Albanian market that bear the most difficult challenges have result to be SMEs. Some of the SMEs challenges are financing, very excessive and time wasting the amount of forms required to be filled and the high interest rates offered by the banks. Infrastructure is another challenge due to the damaged rail system which would have resulted to be a good alternative and a cheaper way of transportation for SMEs.

In Albania the innovation spirit among the enterprises, is still not at the desired levels and online services merely exists due to the lack of proper developed online services infrastructure. Moreover, Albanian enterprises that successful R&D ideas generate more profit and focus very less on them.

In 2013, the number of total employed increased by 28,565 employed or 9. 0 percent compared to 2012. Goods and services producers have contributed respectively by 2. 1 percent and 6. 9 percent in the total increase of employed. Turnover in 2013 reached 1,637 billion ALL, which indicated an increase of 5. 8 percent compared with 2012. Turnover of services producers constitutes 65. 3 percent of total turnover for 2013 and contributed by 4. 8 percent in total increase of turnover.

In total active enterprises in 2013, were employed 344,528 persons. Enterprises with 80 and more employed have engaged 31. 5 percent of the total number of employed which have realized 38. 6 percent of total turnover and have invested 53. 9 percent of total investments. In this size class of enterprises with 80 and more employed, goods producers dominate on the number of active enterprises (57. 5 percent), employed (56. 7 percent) and investments (60. 5 percent). Enterprises with 1-4 employed engaged 34. 5 percent of the total employed and realized 15. 9 percent of total turnover. Small enterprises dominate in services producers on number of active enterprises (88. 3 percent), employed (86. 3 percent) and turnover (85. 4 percent)<sup>1</sup>.

In the below table are presented basic indicators like number of enterprises, employed, turnover and investments for 2013 by size class of enterprises.

**Table 4.** Enterprises, employed, turnover, investments by size class of enterprise, 2013

<sup>1</sup> INSTAT Results of structural survey of economic enterprises, 2013



Ndërmarrjet Enterprises		Të punësuarit Employed		Shitjet neto Turnover		Investimet Investments		Size class of enterprise
nr. / no.	%	nr. / no.	%	mln Lekë/ mln ALL	%	mln Lekë/ mln ALL	%	
<b>84.790</b>	<b>100</b>	<b>344.528</b>	<b>100</b>	<b>1.637.015</b>	<b>100</b>	<b>162.899</b>	<b>100</b>	<b>Total</b>
75.823	89	118.988	35	259.485	16	25.773	16	1-4 employed
6.957	8	58.619	17	393.137	24	28.170	17	5-19 employed
1.561	2	58.427	17	352.603	21	21.165	13	20-79 employed
449	1	108.494	31	631.790	39	87.791	54	80+ employed

Source: INSTAT Results of structural survey of economic enterprises, 2013

Enterprises with 80 and more employed has contributed by 2.3 percent in total annual growth rate of turnover even they have the highest share of turnover by 38.6 percent. Enterprises with 5-19 employed have the major contribution by 24.7 percent.

In the figure no. 3 is presented the basic indicators structure by size class of enterprise. Enterprises with 5-19 employed and 2079 employed constitute respectively 8 percent and 2 percent of total number of active enterprises. The share of number of employed, turnover and investments for both groups of enterprises with 5-19 enterprises and 20-79 enterprises are similar.

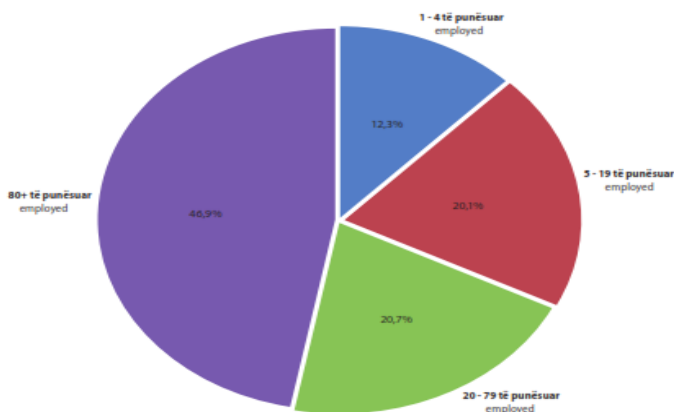
Figure no 3. Basic indicators structure by size class of enterprise, 2013



Source: INSTAT Results of structural survey of economic enterprises, 2013

Enterprises with 80 and more employed although with the smallest share (0.5 percent) in the total active enterprise population generated 46.9 percent of total production. In the below figure 4 is presented the structure of production value as a percentage of each of the enterprises size class for 2013.

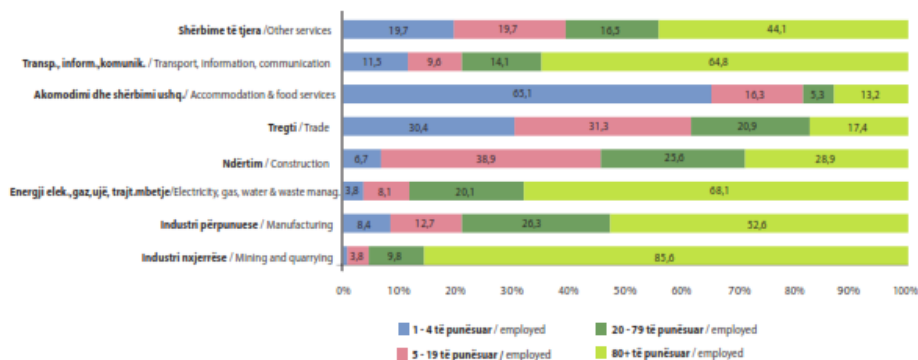
Figure no 4. Production value structure by enterprise size class, 2013



Source: INSTAT Results of structural survey of economic enterprises, 2013

Accommodation and food services sector is the only sector where enterprises with 1-4 employed generate the major percentage of total value added. Enterprises with 5-19 employed generate the major percentage of total value added in construction and transport, information and communication sectors. In all other sectors, the major percentage of the total value added is generated by enterprises with 80 and more employed. In the figure 4 is presented the structure of value added as a percentage of each of the economic activities and enterprise size class for 2013.

Figure no 5. Value added structure by economic activities and enterprise size class, 2013



Source: INSTAT Results of structural survey of economic enterprises, 2013

### 3.2. Albanian's SME in the optic of Small Business Act

The Small Business Act for Europe adopted in 2008 and updated in 2011 reflects the Commission's political will to recognize the central role of SMEs in the EU economy. The some 21 million SMEs create 58% of the value-added, employ 87 million people and account for 85% of the net job creation. SMEs also have a central role in the Commission's overall reform strategy, Europe 2020 and its flagship initiatives, in particular on Industrial policy<sup>1</sup>.

The Commission is monitoring the implementation of the SBA in the Member States with an annual report and country-specific facts sheets<sup>2</sup> which highlight both progress as well as deficiencies.

This work tried to provide a framework to assess convergence of national SME policies with the ten principles of the Small Business Act for Europe (SBA), identifying strong and weak points in policy design and implementation of SBA in Albania, and tried to provide an updating list of priority actions for reform in Albania economy.

It is very important having a dynamic entrepreneurship and a productive industry, able to respond to the challenges of development and integration, regional and global competition. This vision should be focused on:

- a) Continuing improvement of business and investment climate, reducing administrative barriers and business costs;
- b) Development of a productive industrial and mining sector, capable of processing raw materials in the country and increasing the added value through investments and application of new technologies, increasing professionalism and employment, which stimulates creation of a competitive industry.
- c) Creating a partnership between government and business regarding the needs for improved technology, innovation and ability to prepare "skilled workforce".
- d) Creation of a competitive and dynamic industry, foreign investment, growth and diversification of exports, and stimulating the creation of new businesses.

The challenge of this strategy is to enable and to guide investments, which will gradually transform the economic structure to an economy with sectors and products with more added value.

One of the tools to measure the impact assessment of the SBA is recommended by the EU. They talk about the "SME Test", that is the idea to analyze the effects of a legislative proposal on SMEs. It is a key action to implement the "Think Small First" principle - the core principle of the Small Business Act (SBA) for Europe.

The first step of the "SME Test" is maintaining a continuous dialogue with business community. And then according to the ten principles of SBA continuing other suggestions:

1. Entrepreneurship development; drafting and implementation of entrepreneurship and lifelong learning strategy; creative economy; the CSR program; support for start-ups, women in business and youth, expansion of micro credit in rural and urban areas;
2. Increasing competitiveness of SMEs and strengthening technological capacities: establishment of the National Competitiveness Council, the implementation of the innovation program; drafting legal framework for the creation of financial schemes for innovation like voucher, business angels, etc., strengthening the BRIC, the establishment of parks and technological incubators, clusters development, financial support for innovation etc.

<sup>1</sup> [http://ec.europa.eu/enterprise/policies/industrial-competitiveness/industrial-policy/index\\_en.htm](http://ec.europa.eu/enterprise/policies/industrial-competitiveness/industrial-policy/index_en.htm)

<sup>4</sup> SME Performance Review, see :

[http://ec.europa.eu/enterprise/policies/sme/facts-figuresanalysis/performance-review/index\\_en.htm](http://ec.europa.eu/enterprise/policies/sme/facts-figuresanalysis/performance-review/index_en.htm)

3. Improve business services.
4. Improve SME lending - the extension of credit guarantee schemes, the creation of schemes to subsidize bank loan interest, the creation of venture capital schemes, etc.
5. Strengthening institutional capacities – AIDA, etc.
6. Encouraging investment in technology, modernization, diversification and specialization of industrial products in regional & global markets.
7. Manufacturing sector towards value-added products using raw materials of the country (import substitution).
8. Use of existing industrial facilities and cheap labor cost in disadvantaged areas for product development.
9. Promote and support the industry sector in terms of innovation, offering new products and services to market.
10. Enhancing professional capacity and support them in establishing joint ventures for competitive products.

There are also other strategic objectives for accessing the global market:

- ✓ Integration in regional and European markets.
- ✓ Promotion of trade mark "Made in Albania".
- ✓ Support for export product's certification.
- ✓ Promoting cooperation between manufacturers will allow the potential use of "economies of scale".
- ✓ Developing and implementing new credit support schemes for the development of exports.
- ✓ Support to business associations and exporting companies operating in sector and product base.
- ✓ Implementation of an export promotion program with the support of the Diaspora.
- ✓ The disbursement of government funds for competitiveness, ECGF, etc.

The impact assessment of the SBA should follow different steps. As mentioned below its better to start with a guidance to get information about number of business and their sized, proportion of the employment concerned in the different categories of enterprises affected, weight of the different kind of SMEs in the sectors (micro, small and medium ones). To better measure the impact on SMEs should be done an analysis qualitative and then quantitative of the distribution of the potential cost and the benefits with the respect to the business size, differentiating between micro, small medium, and large enterprise. It is important to know to which extent this policies affects the SMEs competitiveness or the business environment. After the result of this analysis, we have to consider the specific operations in order to use possible mitigating measures. The choice of specific measures to use will be made on case by case basis.

#### 4. Conclusions

The monitoring and the coordination of the programs arising from the implementation of the European Charter of SMEs is among the most important objectives. Focusing in the improving of the legal framework will facilitate SME financing by aligning it with European standards, to increase access to more SMEs in the banking sector, the development of training programs, the reduction of administrative barriers so that will increase the competitive capacity of SMEs in international markets.

The main objective of the Government's policy for private sector development has consisted of comprehensive reform of the legal and regulatory framework in the field of business aiming prioritized improving the business climate, reducing administrative barriers, and implementation of the Small Business Act (SBA).

Improving the Business Climate and Institutional Strengthening is also another important objectives of the government. Reforming the inspection system in Albania through the consolidation of the number of inspectorates and enforcement of the Central Inspectorate is necessary to support the implementation of this programmes. Update the registry of Electronic

---

Business Legislation now is something that it completed and amending and further improvements of laws and regulations that affect the cost reduction of doing business in Albania is in continuing progress.

## 5. Recommendations:

Governments have a role to play in order to lower the barriers faced by entrepreneurs who wish to globalize their activities – thereby benefiting, in particular, a category of entrepreneurs whose businesses have high growth and export potential and who could develop and exploit niche markets and expand their businesses on international markets. Governments need to ensure that regulatory, administrative and policy environments do not inhibit access to global markets

- Improvement of legislation in terms of accelerating the creation of new born firms, especially for micro enterprises.
- Alignment of Albanian legislation in the field of SMEs with European standards.
- Review of fiscal legislation in terms of enhancing tax transparency and easing the tax burden, especially for micro enterprises.
- Review of legislation in terms of territorial administration and public procurement rules
- Creating support programs, particularly in terms of financial and technical assistance to increase the competitiveness of SMEs towards regional markets, European and international markets.

## References

Barro, R. J. (1991, May). Economic Growth in a Cross Section of Countries. *The Quarterly Journal of Economics*, 106 (2), 407-443.

D. Fletcher, *Learning to "think global and act local": experiences from the small business sector*, Education + Training, Volume 42, Number 4/5, 2000

European Commission. (2012, June). 2012 Economic and Fiscal Programmes of Albania, Bosnia and Herzegovina: EU Commission's overview and country assessments.

European Commission, Directorate-General for Enterprise and Industry. (2005). *Report on the implementation of the European Charter of Small and Medium Enterprises in Moldova and in the countries of Western Balkans*, 13-16. Belgium: European Commission.

Hunjra, A. (2011). *Determinants of Business Success of Small and Medium Enterprises*. International Journal of Business and Social Science Vol. Nr 20; November 2011.

INSTAT. (2013). *Enterprises Economic Indicators*. Retrieved July 4, 2013

OECD, et al. (2012), SME Policy Index: Western Balkans and Turkey 2012: Progress in the Implementation of the Small Business Act for Europe, OECD Publishing. <http://dx.doi.org/10.1787/9789264178861-en>

PWC-Albania. (2011). *Doing Business in Albania*. Retrieved April 24, 2013, from PWC: [http://www.pwc.com/al/en/assets/Doing\\_Business\\_in\\_Albania.pdf](http://www.pwc.com/al/en/assets/Doing_Business_in_Albania.pdf)

Retrieved July 7, 2013, from EU Bookshop: <http://goo.gl/PP6QbDWorthington>, H. (2012). *The Economic Impact of the Trans-Adriatic Pipeline on Albania*.

Retrieved April 24, 2013, from The Albanian Centre for Competitiveness and International Trade: <http://goo.gl/irbCZv>

South-Eastern Europe: *Lessons from the Global Economic Crisis*, February 2010.

---

Xhepa, S. , & Agolli, M. (2004, September 24). *Small and Medium Enterprises Development, Albania*.

Y. Kraja (Borici), E. Osmani. (2013). *Competitive advantage and its impact in small and medium enterprises (SMEs) (case of Albania)*. European Scientific Journal Vol. 9, No. 16, June 2013.

World Bank. (2004). *Private Sector Development - the case of Albania*. World Bank.

Zef Preçi, Jonida Narazani, Erawatch *Country Reports 2013: Albania*, JRC SCIENCE AND POLICY REPORTS

---

## Problems Associated with the Legal Substance of Real Estate Encumbrances

Mg. iur., PhD cand. Inga Kudeikina

Latvia, Riga Stradiņš University,

Faculty of Law,

ingakudeikina@inbox.lv

### Abstract

*The article is devoted to the problems pertaining to the establishment of encumbrances on real estate. Encumbrances that are created on the basis of law have a different legal substance. As a rule, encumbrances by law are significant and bring benefits to an unlimited number of rightholders. This type of encumbrances includes various protection zones, roads, nature reserves, etc. It is assumed that these encumbrances are for the common good; therefore, the rights of an owner may be restricted. Legislation allows establishing encumbrances without any authorisation from the real estate owner. The objective of the thesis is to analyse the legitimacy of encumbrances based on law in the context of the impairment of owner's property rights. To this end, both descriptive and analytical methods have been employed to analyse the legal grounds for encumbrances and related case-law. The study has relied on both legislation and case-law. The results of the study give strong grounds to conclude that a special procedure could be applied to the establishment of encumbrances in situations when those are intended to meet the needs of the entire society or individual communities of certain regions. Like any other encumbrances, those established by law restrict owner's property rights. A real estate encumbrance should be recognised as a restriction on owner's property rights. Certain remedies should be introduced with a view to balancing the rights and interests of the society and the owner and minimising the adverse effects of encumbrances. Such remedies could comprise an owner's right to claim reasonable compensation, challenge the establishment of encumbrances and initiate their annulment.*

### Introduction

Real estate has always been an essential element of economic growth. Equally important is the role of real estate in meeting social needs and ensuring public welfare. Real estate allows for the exercise of individual's constitutional rights. For instance, real estate provides housing, healthy and safe environment and a possibility of obtaining material benefits from the property. The Universal Declaration of Human Rights serves as the initial legal base of these principles<sup>1</sup> and, according to this Declaration, everyone has the right to own property and no one shall be arbitrarily deprived of his property, everyone has the right to a standard of living adequate for the health and well-being of himself and of his family, including food, clothing, housing and medical care and necessary social services. Democratic countries have implemented these principles into their national laws. Chapter VIII of the Latvian Constitution contains provisions safeguarding fundamental human rights.

2

The path of public development testifies to the approximation of various social and economic processes. Population growth leads to the decrease in isolation and aloofness. Nowadays, the necessity for cooperation is an objective fact. This also refers to the utilisation of properties, which is most often outside the needs of a single owner and the boundaries of a single property, for instance, ensuring of the construction and maintenance of public roads and technical facilities (gas pipelines, communications and power supply equipment), flora and fauna protection. It is evident that this manner of utilisation concerns the needs of the entire society or at least communities of certain regions rather than individual owners. The socially responsible exercise of own rights is coming to the foreground. The partial restriction on an individual's rights for the common good is reflected in legal doctrine. The author shares the opinion of Martijn W. Hesselink, Professor of the Amsterdam Institute for Private Law, that "private law is no longer based on the principle of autonomy" (Martijn W. Hesselink,

---

<sup>1</sup> Vispārējā Cilvēktiesību deklarācija. Available on: <http://www.humanrights.lv/doc/vispaar/vispcd.htm>, [viewed on 10.02.2015]

<sup>2</sup> Latvijas Republikas Satversme, adopted on 15.02.1922, entered into force on 07.11.1922. Published: Latvijas Vēstnesis, No 43, 01.07.1993

2002). This means that legal scholars and society in general face a new challenge, which is to find a balance between the socially responsible policy of property utilisation and the guaranteeing of an owner's rights.

The establishment of encumbrances is a way to safeguard public interests, which would enable the use of real estate owned by another person for the common good.

In this article, the author analyses encumbrances as a legal institution, legal aspects of encumbrances and the need for effective mechanisms to safeguard the rights of owners.

## Research

Legislation does not provide for any uniform definition of the term 'encumbrance'. As a result, this term stands for various legal institutions, such as easement, mortgage, rent, operating restrictions, protection zones. More generally, an encumbrance means any third party's rights to real estate. The substance and types of encumbrances as a legal institution may be understood by means of the interpretation of law and the analysis of the legal system.

Encumbrances by their grounds can be categorised as follows:

- 1) arising from private law;
- 2) arising from public law.

In private law, mortgage, rent and easement should be viewed as encumbrances. The common feature of these legal institutions is the grounds for their establishment, which can be either law, or a contract, or a court judgment. As a rule, these encumbrances are defined on an individual basis and created with the consent of the party concerned (real estate owner) or at least with his knowledge. For instance, easements are established for the benefit of a particular person (easement in gross) or for a particular property (appurtenant easement), mortgage is registered for a particular property, and it is a specific property that is rented. On certain occasions, the encumbrance may result not only in the restriction on the rights of the party concerned (real estate owner) but, on the contrary, in material benefits for this party, such as rental.

The grounds for terminating these encumbrances are accurately defined by law.<sup>1</sup> For the most part, encumbrances may be terminated by a relevant agreement between the parties and due to the expiry of their term.

As regards encumbrances arising from private law, obligations are normally established between two parties, i. e. the owner and the party in whose favour the encumbrance is created. The party concerned (real estate owner) is aware of the grounds for terminating encumbrances in advance or is allowed to refer to these grounds by law. Certain kinds of encumbrances bring material benefits to the owner, thereby minimising the adverse effects of the encumbrance, i. e. compensating for the restrictions attached to the exercise of property rights. Considering that obligations arising out of encumbrances are established between rightholders, while legal relationships are associated with real estate, the legal substance of encumbrances may be characterised as a mixed legal relationship. Property law treats encumbrances as *jura in re aliena*, while the law of obligations views them as a duty to comply provided for the party concerned.

These encumbrances have only immaterial significance for public interests.

Encumbrances that are meaningful for society arise from public law. They could be described as a matter of national interests. These encumbrances represent territories and facilities that are necessary for the safeguarding of significant public interests and the protection and sustainable use of natural resources.<sup>2</sup> Spatial planning is a duty of public authorities, and the owner has only a minor role in introducing encumbrances. According to Section 4 (1) of the Spatial Development Planning Law, spatial development must be planned through public participation, while Section 4 (4) of this Law provides

<sup>1</sup> For instance, see Sections 1237 and 1379 of the Civil Law. Civillikums. Trešā daļa. Lietu tiesības: Latvijas Republikas likums, adopted on 28.01.1937, entered into force on 01.09.1992. Published: Valdības Vēstnesis, No 44, 24.02.1937; Section 2165 of the Civil Law. Civillikums. Ceturtā daļa. Saisību tiesības: Latvijas Republikas likums, adopted on 28.01.1937, entered into force on 01.03.1993. Published: Ziņotājs, No 1, 14.01.1993

<sup>2</sup> Teritorijas attīstības plānošanas likums: Latvijas Republikas likums, adopted on 13.10.2011, entered into force on 01.12.2011. Published: Latvijas Vēstnesis, No 173, 02.11.2011



that the interests of private individuals and public interests must be balanced with sustainable spatial development. <sup>1</sup> The aforementioned Law contains a declaratory provision. There are grounds for criticism of the fact that owners whose properties are subject to encumbrances are not individually involved in the solution of matters, which is also confirmed by the case-law of the Constitutional Court of the Republic of Latvia showing that applications challenging the detail planning of territories have been lodged nine times. <sup>2</sup> In all these cases, the encumbrances have been recognised as proportionate and complying with the Basic Law. The case-law treats spatial planning as legislation. <sup>3</sup> Therefore, no appeals are allowed because laws may not be appealed through courts of general jurisdiction.

Encumbrances are determined by public authorities (the Cabinet, sectoral ministries, planning regions and local governments) by developing spatial planning. A spatial plan is the initial document providing for encumbrances. The next step is the updating of encumbrances and their registration in a relevant property file of the Land Registry. In accordance with Section 41 (2) of the Land Registry Law<sup>4</sup>, the process takes place online between two public authorities (the State Land Service and the Land Registry), without the consent of the real estate owner. It should be noted that a decision taken by a judge of the Land Registry Department concerning the registration of actual encumbrances is not subject to appeal.

Annex 2 "Unified Classification of Encumbered Territories and Real Estate Encumbrances" to Cabinet Regulation No 61 of 4 February 2014 serves as the legal basis for establishing encumbrances. <sup>5</sup> According to this Annex, there exist the following encumbrances: the coastal protection zone of the Baltic Sea and the Gulf of Riga, surface water body protection zones, protection zones around marshes, territories of state-protected cultural monuments and their protection zones, protection zones around water-supply points, protection zones along streets and motorways, protection zones along railroads, protection zones along electronic communications networks, protection zones around national meteorological and hydrometric gauging stations, protection zones along power grids, protection zones along heating networks, protection zones around hydrotechnical and amelioration constructions and installations, protection zones along water-supply and sewage networks, protection zones around geodetic points, protection zones around technical means of navigation, gas-supply protection zones, protection zones around state-protected facilities and the state border, protection zones around optical telescopes and radio telescopes, protection zones around facilities subject to enhanced sanitary requirements and territories where pollutants have been or could be detected, protection zones around hydrocarbon extraction sites, as well as pipelines, tanks, storage facilities for oil, oil products, hazardous chemicals and chemical products and related refineries and handling companies, petrol stations, special areas of conservation and their zones, windbreaking forest strips, national subsoil blocks, tow-paths, territories subject to construction restrictions specified in spatial development planning documents and territories designated by local governments for public access to public territories.

The establishment of encumbrances is determined by several laws, including the Protection Zone Law<sup>6</sup>, the Fishery Law<sup>7</sup>, the Law on the Protection of Cultural Monuments<sup>8</sup>, while six other laws deal with certain elements of the creation of encumbrances. The analysis of the applicable legislation has revealed that encumbrances are determined only by public authorities based on law or their decisions (administrative acts) without considering the opinion of real estate owners. Disagreement of the real estate owner may not be an obstacle to encumbrances. The author believes that the absence of a clear procedure for appealing against decisions adopted by public authorities for owners whose properties are thereby encumbered is contrary to the principles of a democratic state.

---

<sup>1</sup> Ibid.

<sup>2</sup> Latvijas Republikas Satversmes tiesas dati. Available on: <http://www.satv.tiesa.gov.lv/?lang=1&mid=19> [viewed on 10.02.2015]

<sup>3</sup> Latvijas Republikas Augstākās Tiesas Judikatūra. Tiesu prakses apkopojumi Administratīvajās tiesībās. 2013.gads Tiesu prakses apkopojums teritorijas plānošanas, būvniecības un vides lietās 2008 - 2012. Available on: <http://at.gov.lv/lv/judikatura/tiesu-prakses-apkopojumi/administrativajās-tiesībās/> [viewed on 10.02.2015]

<sup>4</sup> Zemesgrāmatu likums: Latvijas Republikas likums, adopted on 22.12.1937, entered into force on 05.04.1993. Published: Latvijas Vēstnesis, No 11, 08.04.1993

<sup>5</sup> Latvijas Republikas Ministru kabineta noteikumi Nr. 61, adopted on 04.02.2014, entered into force on 13.02.2014. Published: Latvijas Vēstnesis, No 31, 12.02.2014

<sup>6</sup> Aizsargjoslu likums: Latvijas Republikas likums, adopted on 05.02.1997, entered into force on 11.03.1997. Published: Latvijas Vēstnesis, No 56/57, 25.02.1997

<sup>7</sup> Zvejniecības likums: Latvijas Republikas likums, adopted on 12.04.1995, entered into force on 12.05.1995. Published: Latvijas Vēstnesis, No 66, 28.04.1995

<sup>8</sup> Likums „Par kultūras pieminekļu aizsardzību”: Latvijas Republikas likums, adopted on 12.02.1992, entered into force on 11.03.1992. Published: "Ziņotājs", 10, 05.03.1992

The uncertainty of rightholders in whose favour encumbrances are created is inherent in the encumbrances established by public authorities. Encumbrances are made *a priori* to satisfy the needs of society and for the common good. Society is represented by the government in relations with real estate owners and, therefore, these legal relationships are subject in full to the principles of public law. The Constitutional Court of the Republic of Latvia has held that "both the general principles of law and of public administration and the principles of spatial planning must serve as guidance for the proper and adequate exercise of discretion in the field of spatial planning"<sup>1</sup> and "in the course of the development of spatial (detail) plans, the local government must act as an unbiased and neutral mediator balancing the interests of the developer of a particular territory and the community concerned, hear and make an objective assessment of the opinions of all the parties involved regarding the most appropriate and suitable way of development of the particular territory, as well as comply with the requirements set out in spatial planning laws".<sup>2</sup>

The above means that whenever public authorities by their decisions cause impairment of property rights, these decisions must be particularly solid, lawful and proportionate. Based on the case-law of the European Court of Human Rights, researchers have concluded that restrictions must always be specific and set within clearly defined limits, with respect for the law (laws must be freely accessible, clearly formulated and understandable), public interests (spatial development, defence of democracy, elimination of consequences, protection of national financial interests, road construction, land reform, etc. ) and proportionality (the balance between the interests of society and owners) (Сардеева, 2014).

An objective assessment can only be made of the lawfulness of encumbrances, while public interests and the balance between the interests of society and owners can only be viewed on an individual basis. No uniform procedure for defining the scope of public interests and proportionality can be introduced because characteristics (the level of economic and social development of the community (populated location), development priorities and targets to be achieved, the type and extent of encumbrances) will always vary. Consequently, the competence of officials and their understanding of fundamental human rights and the ability of courts to ensure lawfulness and equality in disputes – these are factors that are of primary importance in maintaining social balance and justice.

The author classifies encumbrances depending on their form as follows:

- 1) operating prohibitions (restrictions);
- 2) prohibitions (restrictions) of the use of territories;
- 3) restrictions on the exercise of rights.

Operating prohibitions (restrictions) mean that in an encumbered territory the owner may not carry on certain economic activity or economic activities are allowed only to a limited extent and subject to special licences. For instance, no operations may be authorised in protection zones around water-supply points<sup>3</sup>, and nature reserves may have areas where natural resources are fully excluded from economic or other activities. Limited economic activities may be allowed in certain areas of nature reserves<sup>4</sup>, and operating restrictions are effective in forests during the breeding season.<sup>5</sup> It should be concluded that, in order to protect public interests, owners are prohibited from pursuing any profit-making activities which are associated with their properties but have environmental impacts, or are carried out in heritage sites, or involve facilities of public significance, or are performed during a certain period.

Encumbrances associated with the use of territories have similar substance. The only difference is that they are static by nature. A territory should be recognised as encumbered merely due to the existence of an encumbrance. These encumbrances include all kinds of protection zones which may not be used in any manner. In fact, these are territories excluded from civil transactions. Protection zones may have a width ranging from 1m up to 300m. On certain occasions,

<sup>1</sup> Latvijas Republikas Satversmes tiesas 2004. gada 9. marta spriedums lietā Nr. 2003-16-05, paragraph 5. Published: Latvijas Vēstnesis No 38, 10.03.2004

<sup>2</sup> Latvijas Republikas Satversmes tiesas 2007. gada 28. novembra lēmums par tiesvedības izbeigšanu lietā Nr. 2007-16-03, paragraph 7. Published: Latvijas Vēstnesis No 194, 04.12.2007

<sup>3</sup> Aizsargjoslu likums: Latvijas Republikas likums, adopted on 05.02.1997, entered into force on 11.03.1997. Published: Latvijas Vēstnesis No 56/57, 25.02.1997, Section 39(1)(1)

<sup>4</sup> Par īpaši aizsargājamām dabas teritorijām: Latvijas Republikas likums, adopted on 02.03.1993, entered into force on 07.04.1993. Published: Latvijas Vēstnesis No 5, 25.03.1993, Section 3(2)

<sup>5</sup> Meža likums: Latvijas Republikas likums, adopted on 24.02.2000, entered into force on 17.03.2000. Published: Latvijas Vēstnesis No 98/99, 16.03.2000, Section 37(4)

considering the relation of the width of protection zones to the size of a property, the encumbered territory may be rather large, taking the major part of the property, thereby leading to a considerable decrease in the cadastral value. According to the State Land Service, the value of land may be down by 20% if the relevant property is located, for instance, in the dune protection zone of the Baltic Sea and the Gulf of Riga or in the territory of a cultural monument. <sup>1</sup> It should be concluded that encumbrances, which take the form of protection zones, not only prevent the owners from using certain part of their properties but also reduce the possibility of earning maximum benefits therefrom (i. e. sell at a higher price).

The third type of encumbrances provides for a special procedure for transactions. In the cases referred to in law, the owner of encumbered real estate is bound by pre-emptive rights granted to the state. Pursuant to Section 35 (1) of the Law on Special Areas of Conservation, the state has a pre-emption right to land located in nature conservation areas, nature reserves and natural monuments. <sup>2</sup> Hence, the owner of the land is not free to exercise his rights when choosing the buyer and he has to take into account the state as a rightholder and potential party to the transaction.

In conclusion, the establishment of encumbrances leads to a considerably narrower scope of an owner's property rights, practically excluding the element of discretion, thereby reducing the possibility of obtaining economic benefits and restricting the freedom of transactions. Mechanisms offered by the state to minimise restrictions are essential to ensure compliance with the principle of proportionality. Legislation provides for certain compensation only for one kind of encumbrances, i. e. operating restrictions, and it should be emphasised that this provision refers only to agriculture and forest management. <sup>3</sup> It should be added that in certain instances a land owner may demand repurchase of the land, and this right is in line with the mechanism intended to minimise the adverse effects to be faced by the owner. In view of the spread of protection zones and their effect on property rights of owners, the author takes a critical view of the law-giver's position whereby no compensation is provided for the establishment of protection zones. It is evident that legislation views only operating restrictions as encumbrances. This approach narrows the interpretation of encumbrances as a legal institution because any encumbrance (not only operating restrictions) may limit property rights of owners. Moreover, any encumbrance should be viewed in the context of proportionality. The author believes that the opinion given in scientific literature that property rights are relative and owners have obligations towards others is still questionable. The relevant obligations are more significant and are not merely limited to the avoidance of harm to others. Within their community, owners must share their property or benefits therefrom to maintain peace and social order (Gregory S. Alexander et Eduardo M. Peñalver, 2012). The author criticises the form and manner of participation and society's contribution in response to encumbrances rather than the sharing requirement.

The owner makes it possible for the public to derive benefits from his property and, therefore, the owner has already fulfilled his obligations towards the public. The author is of the opinion that, without compensating for the restrictions caused by encumbrances, property rights of owners are restricted unreasonably and the balance between the duty to share a property to satisfy public needs and the right to property is destroyed.

## Conclusions

An encumbrance should be understood as de facto and legal limitations imposed on real estate owned by private owners in the form of restrictions on the use of property and the special procedure for transactions, as may be necessary for public needs. An encumbrance is a way how private property may be used for public needs. Encumbrances have a legitimate goal and origin. Whenever encumbrances are established and maintained, the protection of property rights of owners by means of the effective legislation is not sufficient, nor is it commensurate with duties and restrictions imposed by encumbrances.

<sup>1</sup> Valsts Zemes dienesta informācija par kadastrālo vērtību ietekmējošiem apgrūtinājumiem. Available on: <http://kadastralavertiba.lv/profesionali/vertibu-ietekmejosie-faktori/apgrutinajumi/> [viewed on 12.02.2015]

<sup>2</sup> Par īpaši aizsargājamām dabas teritorijām: Latvijas Republikas likums, adopted on 02.03.1993, entered into force on 07.04.1993. Published: Latvijas Vēstnesis No 5, 25.03.1993, Section 35(1)

<sup>3</sup> Par kompensāciju par saimnieciskās darbības ierobežojumiem aizsargājamās teritorijās: Latvijas Republikas likums, adopted on 04.04.2013, entered into force on 01.06.2013. Published: Latvijas vēstnesis No 74, 17.04.2013

## Recommendations

The improvement of the legislation governing encumbrances should be viewed in the context of the protection of owners' rights because the existing encumbrance regulation focuses on public interests. Property rights and mechanisms to ensure the exercise of these rights are primarily civil institutions to be considered in the development of legislation. For the purposes of proportionality, it is necessary to increase the participation of real estate owners in the creation of encumbrances.

With a view to ensuring the uniform legal treatment and rendering the establishment of encumbrances more transparent, it is desirable to consolidate laws governing encumbrances and introduce regulation whereby owners could initiate alteration or annulment of encumbrances under certain conditions. The legal nature of spatial planning is worthy of debate because limited possibilities of appeals testify to the misunderstanding of democracy.

The article has been drawn up under the ESF project "Support to Doctoral Candidates for the Completion of Study Programmes and Acquisition of Scientific Degrees at Riga Stradiņš University", Agreement No 2009/0147/1DP/1. 1. 2. 1. 2/09/IPIA/VIAA/009.



IEGULDĪJUMS TAVĀ NĀKOTNĒ

## References

Hesselink, M. W. *The New European Private Law: essays on the future of private law in Europe*. Hague: Kluwer Law International, 2002. 283 p.

Сагдеева, Л. В. *Право на защиту собственности в актах Европейского Суда по правам человека*. Москва, Статут, 2014. - 319 с.

G. S. Alexander, E. M. Peñalver *An Introduction to Property theory*, Cambridge University Press, 2012, 234 p.  
Latvijas Republikas Satversme, adopted on 15. 02. 1922, entered into force on 07. 11. 1922. Published: *Latvijas Vēstnesis*, No 43, 01. 07. 1993.

Civillikums. Trešā daļa. Lietu tiesības: Latvijas Republikas likums, adopted on 28. 01. 1937, entered into force on 01. 09. 1992. Published: *Valdības Vēstnesis*, No 44, 24. 02. 1937.

Civillikums. Ceturtdāļa. Saistību tiesības: Latvijas Republikas likums, adopted on 28. 01. 1937, entered into force on 01. 03. 1993. Published: *Ziņotājs*, No 1, 14. 01. 1993.

Teritorijas attīstības plānošanas likums: Latvijas Republikas likums, adopted on 13. 10. 2011, entered into force on 01. 12. 2011. Published: *Latvijas Vēstnesis*, No 173, 02. 11. 2011.

Zemesgrāmatu likums: Latvijas Republikas likums, adopted on 22. 12. 1937, entered into force on 05. 04. 1993. Published: *Latvijas Vēstnesis*, No 11, 08. 04. 1993.

Latvijas Republikas Ministru kabineta noteikumi Nr. 61, adopted on 04. 02. 2014, entered into force on 13. 02. 2014. Published: *Latvijas Vēstnesis* No 31, 12. 02. 2014

---

Aizsargjoslu likums: Latvijas Republikas likums, adopted on 05. 02. 1997, entered into force on 11. 03. 1997. Published: Latvijas Vēstnesis No 56/57, 25. 02. 1997.

Zvejniecības likums: Latvijas Republikas likums, adopted on 12. 04. 1995, entered into force on 12. 05. 1995. Published: Latvijas Vēstnesis No 66, 28. 04. 1995.

Likums „Par kultūras pieminekļu aizsardzību”: Latvijas Republikas likums, adopted on 12. 02. 1992, entered into force on 11. 03. 1992. Publicēts: "Ziņotājs", 10, 05. 03. 1992.

Latvijas Republikas Satversmes tiesas 2004. gada 9. marta spriedums lietā Nr. 2003-16-05, paragraph 5. Published: Latvijas Vēstnesis No 38, 10. 03. 2004.

Latvijas Republikas Satversmes tiesas 2007. gada 28. novembra lēmums par tiesvedības izbeigšanu lietā Nr. 2007-16-03, paragraph 7. Published: Latvijas Vēstnesis No 194, 04. 12. 2007.

Par īpaši aizsargājamām dabas teritorijām: Latvijas Republikas likums, adopted on 02. 03. 1993, entered into force on 07. 04. 1993. Published: Latvijas Vēstnesis No 5, 25. 03. 1993, Section 3 (2).

Meža likums: Latvijas Republikas likums, adopted on 24. 02. 2000, entered into force on 17. 03. 2000. Published: Latvijas Vēstnesis No 98/99, 16. 03. 2000, Section 37 (4).

Par kompensāciju par saimnieciskās darbības ierobežojumiem aizsargājamās teritorijās: Latvijas Republikas likums, adopted on 04. 04. 2013, entered into force on 01. 06. 2013. Published: Latvijas vēstnesis No 74, 17. 04. 2013.

Vispārējā Cilvēktiesību deklarācija. Available on: <http://www.humanrights.lv/doc/vispaar/vispcd.htm>, [viewed on 10. 02. 2015]

Latvijas Republikas Satversmes tiesas dati. Available on: <http://www.satv.tiesa.gov.lv/?lang=1&mid=19> [viewed on 10. 02. 2015]

Latvijas Republikas Augstākās Tiesas Judikatūra. Tiesu prakses apkopojumi Administratīvajās tiesībās. 2013. gads Tiesu prakses apkopojums teritorijas plānošanas, būvniecības un vides lietās 2008 - 2012. Available on: <http://at.gov.lv/lv/judikatura/tiesu-prakses-apkopojumi/administrativajas-tiesibas/>. [viewed on 10. 02. 2015]

Valsts Zemes dienesta informācija par kadastrālo vērtību ietekmējošiem apgrūtinājumiem. Available on: <http://kadastralavertiba.lv/profesionali/vertibu-ietekmejosie-faktori/apgrutinajumi/> [viewed on 12. 02. 2015]

---

## Investigating the Twin Deficits in Albania

**Ermira H. Kalaj, Ph. D.**

Aleksander Moisiu University, Durres

[ermirahoxha@uamd.edu.al](mailto:ermirahoxha@uamd.edu.al)

**Prof. Dr. Mithat Mema**

Aleksander Moisiu University, Durres

[memamithat@gmail.com](mailto:memamithat@gmail.com)

### Abstract

*This paper focuses on the direction of causality between budget deficit and current account deficit in Albania based on Granger causality tests. We use annual macroeconomic data for the period from 1992 to 2014. Before proceeding with the empirical analysis we test for unit root, the non-parametric Phillips-Peron test is conducted. The classical Granger test is extended including control variables such as private investment and savings, exchange rates, inflation rate, and interest rate. Empirical results support the evidence of a causal link between the twin deficits. In this sense fiscal budget cannot be considered as a fully controlled variable. A fiscal policy has important macroeconomic implications in the foreign trade indicators. To further investigate on the robustness of our results we examined the causal link between budget deficit and current account deficit based on the simultaneous equation. Results still persist in the bidirectional relationship between these two deficits.*

**Keywords:** twin deficits, granger test, simultaneous equation

### Introduction

Economic theory suggests that there is a link between the budget deficit and the current account deficit in an open economy. A first theoretical explanation of the relation between budget deficit and current account deficit is found in the Mundell-Fleming model (Blanchard, 2006). According to this model an increase in the budget deficit of an economy leads to an increase in its interest rates that, in turn will generate an appreciation of exchange rates. As a result exports become relatively more expensive and imports cheaper leading toward a current account deficit.

Friedman (2000) suggests that when deficits are used correctly, they are important to financing growth and reducing unemployment. However, many economists argue against the supposed benefits of deficit spending that increased deficit spending can only lead to higher inflation and a non efficient allocation of resources. Additionally, as deficits grow and governments begin financing their budgets with capital from foreign markets capital inflow increases and liabilities to foreign investors and governments increase.

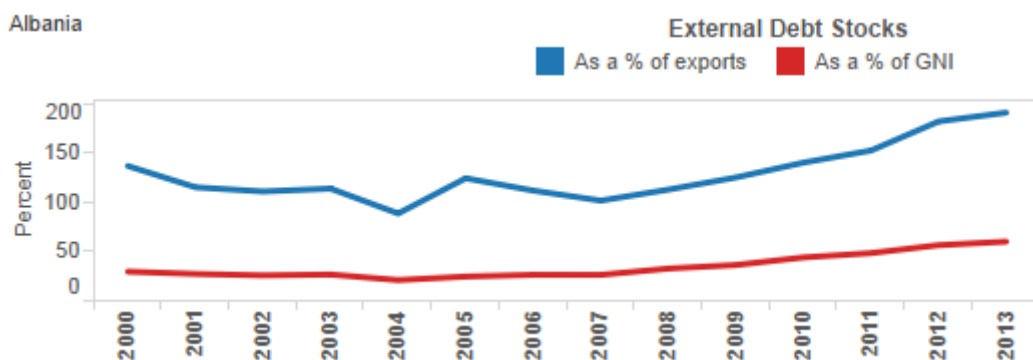
Another theoretical explanation is the Keynesian absorption model. Issuing bonds to finance the budget deficit leads to higher consumption expenditure due to wealth effects and they raise interest rates. These higher interest rates appreciate the currency and, because of the resulting loss in competitiveness, worsen the current account balance. However, this traditional view is challenged by the Ricardian equivalence hypothesis (Barro, 1989) which states that an increase in a budget deficit will be compensated by increases in private savings.

---

Therefore, it is worth investigating on the link between current account and budget imbalances in transition countries, such as Albania. This country sustained high economic growth in the decade prior to the 2008 global financial crisis. During

1998- 2008, annual growth averaged 6 percent in real terms with a fivefold increase in per capita GDP to above US\$4,000, propelling Albania from being one of the poorest countries in Europe to middle income status (World Bank, 2015). Since 2008, the global financial crisis and the subsequent Eurozone crisis led to a significant slow-down in Albania's growth. Albania was able to avoid a recession but GDP growth slowed to less than 3 percent on average between 2009 and 2013 as exports, remittances and inflows suffered. As growth slowed down, public debt surged and amount overdue accumulated. Albania's public debt has surged from 54. 7 percent in 2008 to 70. 0 percent in 2013, the stock of external debt is shown in figure 1. High public debt are weighing heavily on Albania's growth prospects and threatening to reverse the significant progress in reducing poverty. Domestic and external vulnerabilities are high and continue to pose risks to macroeconomic stability.

**Figure 1- Trends of External Debt Stocks**



Source: World Bank, Debt Data 2014

### Literature review

One of the earliest empirical studies examining the relation between budget deficit and current account deficit is that of Enders and Lee (1990). In their paper they developed a two-country model in which infinitely lived individuals view government debt as a future tax liability. The direct implication is that substitution of taxes for government debt issue does not result in a current account deficit. In their tests, the authors restricted the information set to include a limited number of variables. Aside from the consumption function, they did not estimate the structural equations of the model because they tested only the neutrality implication of the Ricardian equivalence hypothesis.

Using US annual data over the 1950 to 1988 period Biswas et al. (1992) further investigate on the relationship between budget deficit and current account deficit. In their study they made a distinction between structural and actual budget deficits. Instead of an arbitrary choice of lag structure, they used Hsiao minimum final prediction error criterion to determine the optimum lag lengths of the explanatory variables. Their analysis reveals a unidirectional causal relation running from structural budget deficits to net exports. However, findings indicate a bi-directional causal relation between actual budget deficits and net exports. Their findings suggest important policy implications.

Rosensweig and Tallman (1993) empirically investigated on two questions: do increased government deficits cause dollar appreciation, and do fiscal deficits lead to higher trade deficits? They examined these issues using a VAR system, generating probability bounds to assess significance. The results provided some evidence that growing government deficits appreciate the dollar, and support the "twin deficit" notion that government deficits contribute to current account deficits.

Using macroeconomic quarterly data for Brazil from 1973 through 1991, Islam (1998) examined empirically the causal relationship between budget deficit and trade deficit. This relationship is investigated using Granger test causality. The appropriate lag length was determined by using Akaike's FPE criterion.

Using international data from a sample of twenty developed and developing countries Kouassi et al. (2004) found either unidirectional or bidirectional evidence between the twin deficits for some developing countries. However, the results for developed countries are less convincing. Following Engle and Granger they used a three step procedure to test for the direction of the causality.

Bagnai (2006) used time series data to evaluate the impact of structural breaks on the long-run and short-run relation between current account, government, and investments in 22 OECD countries. The author found that when allowing for possible existence of structural break, the data reveal more clearly a long-run relation between the current account and the variable controls. Since the techniques adopted account for only one change point, he tested the robustness of the empirical results by conducting the tests on a subsample excluding the two oil price shocks.

### Theoretical framework

In a Keynesian open economy model, gross national product is the sum of private consumption expenditures, gross private domestic investment expenditure, government expenditure and exports over imports, as follow:

$$Y = C + I + G + X - M$$

Otherwise, gross national income equals consumption expenditures, savings, and taxes:

$$Y = C + S + T$$

Rearranging terms yields:

$$X - M = (S - I) + (T - G)$$

The final equation suggests that net exports equal private and public savings. In an open economy with access to international financial markets there will be a relationship between the current account deficit and the government deficit.

### Data and methodology

Macroeconomic data from the International Debt Data (World Bank, 2015) are used to give answers to the questions related with the relationship between the current account deficit and government deficit.

According to granger a time series  $X_t$  causes another time series  $Y_t$ . If current  $Y_t$  can be predicted better using past values of  $X_t$ , than by not doing so then all other relevant information like past  $Y_t$  is taken into consideration in both case. Appropriate lag lengths of relevant variables for tests of causality were determined by Akaike's final prediction error.



To further investigate on the robustness of our results we examined the causal link between budget deficit and current account deficit based on the simultaneous equation. The test is extended including control variables such as private investment and savings, exchange rates, inflation rate, and interest rate.

### Empirical results

The empirical results of Granger's test are presented in table 1. The results of our long-run causality provide support for the importance of budget deficit in the presence of budget deficit.

**Table 1 – Long-run causality test between current account (CA) and budget deficit (BD)**

Causality test	Number of Lags	F statistic	Probability	Chi-square	Probability
CA does not Granger cause BD	4	1.38	0.38	5.52	0.24
BD does not Granger cause CA	4	1.97	0.26	7.88*	0.09

*Note:* \*\*\*, \*\*, and \* indicate statistical significance, respectively at the 1, 5 and 10 per cent level, or better.

While the F statistics as well as the associated probabilities does not allow us to reject the null hypothesis of no bi-directional causality between current account deficit and budget deficit, the chi-square shows a rejection of the null hypothesis. This means that while budget deficit granger causes the current account deficit, the inverse is not statistically significant.

Results still hold in a bi-directional way when applying the simultaneous equation model. We further extend our analysis by adding other control variables such as; private investment and savings, exchange rates, inflation rate, and interest rate.

### Conclusions and comments

This article analyses macroeconomic data from Albania for a period through 1991 to 2014 in order to capture the relationship between the current account deficit and the budget deficit. Results from the long-run Granger causality test are mixed. On one hand there is a statistically significant unidirectional causality from budget deficit to current account deficit. While on the other hand there is no statistical significance on the causal relation of current account deficit on the budget deficit. However, empirical results obtained from the simultaneous equation model seem to be more convincing in terms of bi-directional causality.

The results have policy implications, ways to reduce the current account deficit may be the raise of national savings by reducing the budget deficit and increasing the private savings. Even though fiscal policy has macroeconomic implications the budgetary impact of exogenous changes in the current account variable cannot be mistreated.

---

**References**

- Bagnai, A. (2006). Structural breaks and the twin deficits hypothesis. *International Economics and Economic Policy*, Springer , 137-155.
- Barro, R. (1989). The ricardian approach to budget deficits. *Journal of Economic Perspectives* , 37-54.
- Biswas, B. , Tribedy, G. , & Saunders, P. (1992). Further analysis on the twin deficits. *Contemporary Policy* , 104-108.
- Blanchard, O. (2006). *Macroeconomics*. Upper Saddle River: Prentice Hall.
- Clarke, G. R. (2011). How Petty is Petty Corruption? Evidence from Firm Surveys in Africa. *World Development* , 39 (7), 1122-1132.
- Enders, R. , & Lee, B. (1990). Current account and budget deficits: twins or distant cousins? *Review of Economics and Statistics* , 373-381.
- Friedman, B. J. (2000). What have we learned from the Reagan deficits and their disappearance? . *National Bureau of Economic Research Working Paper Series* .
- Islam, M. F. (1998). Brazil's twin deficits: An empirical examination. *Atlantic Economic Journal* , 121-128.
- Kenyon, T. (2008). Tax Evasion, Disclosure, and Participation in Financial Markets: Evidence from Brazilian Firms. *World Development* , 36 (11), 2512-2525.
- Kouassi, E. , Mougoue, M. , & Kymn, K. (2004). Causality tests of the relationship between the twin deficits. *Empirical Economics* , 503-525.
- Rosensweig J, A. , & Tallman, E. W. (1993). Fiscal policy and trade adjustment: are the deficits really twins? *Economic Inquiry* , 580-594.

## The Integrated Model of Dwyer and Kim as a Tool to Evaluate and Rank the Determinant Attributes of a Tourist Destination Competitiveness

Sonila Berdo

University Pavaresia Vlore, Albania.

[sonila.berdo@unipavaresia.edu.al](mailto:sonila.berdo@unipavaresia.edu.al) or [soniberdo@yahoo.it](mailto:soniberdo@yahoo.it)

### Abstract

*The aim of this paper is to explain the importance of the Integrated model of Dwyer & Kim, in terms of its application to different tourist destinations, as a valuable tool to measure and evaluate the impact of different factors in their competitiveness level and making possible to compare them to each other. Managing tourist destination competitiveness is a very challenging process. This model serves as a tool to identify, to evaluate and rank the importance of different attributes and sub-attributes of a tourist destination. Having the information on the relative importance of all the factors and sub-factors makes destinations/countries well oriented to select and invest or effectively manage those factors which are of high impact in achieving and maintaining the sustainable competitiveness level in the market. How this model is composed? Which factors and sub-factors are involved in this model for being evaluated and ranked, as tourist destination competitiveness attributes? How these factors and sub-factors can be converted in measurable ones? How this model can be applied in practice? Answering the above questions and giving some evidences in different countries about the last question will be the objectives of this paper. After a literature review process on different models of evaluating tourist destination competitiveness, the integrated model of Dwyer & Kim, here presented, results as the most completed model which does integrate the both sides of the tourist market factors, those of the supply and demand side.*

**Keywords:** tourist destination competitiveness, Dwyer & Kim model, tourist factors ranking.

### Introduction

Nowadays, tourist destinations are operating in terms of the international market. They are involved into the accelerated process of globalization, under the conditions of economic, social and technological changes and that of a dynamic market. Consequently, competition between destinations is growing and is becoming increasingly difficult to be managed. In order that a destination becomes and remains successful in the market, it must be able to offer a unique experience to the tourists, which is produced by the combination of attributes of that destination.

In a context like this, the tourist destination competitiveness needs to be analysed and strategically managed, even though this is associated with a variety of problems and challenges such as the impacts of factors and unpredictable events; a part of attributes are difficult to be managed; in managing elements of an attribute, a large number of organizations do affect; tourism development is associated with costs and benefits and there is no consensus on the social, economic and environmental impacts that may have; destinations do not establish clear development targets on which to assess the competitiveness of their performances; it suffers by lack of objective information, measures and indicators; given that competitiveness is a relative concept, the competitiveness of a destination is a function of what happens at the destination.

Even though tourist destination competitiveness affords so many problems and challenges like above mentioned, many authors have contributed with their researches in conceptualising and creating competitiveness models that help and facilitate the process of identifying, analysing, measuring and evaluating the competitiveness level of a tourist destination, explaining the competitive advantages resources and trying to lead to the right path the destination competitiveness management in a sustainable way. Here, it can be mentioned different models like: Tourist area life cycle model (Butler, 1980); National Diamond of Porter (Porter, 1990), Crouch and Ritchie model (2000); and the model which this paper is dedicated to, that of Integrated model of Dwyer and Kim (2003).

Each of the tourist destination models according to the theoretical analyses and empirical evidences offered by tourist literature shows its own advantages and disadvantages, depending on the study context where they are used.

### **Integrated Model of Destination Competitiveness of Dwyer & Kim**

One of the last trends in the tourism research field is that of analysing the relative importance of the destination competitiveness attributes, in order to manage effectively the limited resources of a destination. The models which makes possible to identify, to measure, to evaluate and rank the attributes and determinant factors of a tourist destination and to compare different tourist destinations with each other related to their specific attributes, there are especially two of them: Crouch and Ritchie model and Integrated model of Dwyer & Kim.

These two models are of general nature and as such can be implemented to any tourist destination.

Compared to Crouch and Ritchie model, that of Dwyer and Kim besides taking in consideration factors such as the destination policy, planning and development, destination management, core resources and attractive factors, and supportive resources which constitute the tourist supply side, do include also factors of tourist demand side. But, how is composed this model? Which are the categories of attributes and sub-attributes, included in this model? How can they be converted in identifiable variables? How can this model be put in practice? These questions and some cases where this model has been applied will be explained in the following part of this article.

### **Integrated Model of Dwyer and Kim Composition**

According to Dwyer & Kim model, the tourist destination competitiveness is conceptualized as a function of six categories of attributes, which are as follows: Inherited resources, created resources, supporting resources, destination management, demand factors and situational factors. Each of the attributes' categories does include sub-attributes which in total summarize 85 elements, structured as a decision making tree. Below, it is described briefly each of the attributes' categories and also in each case are given the variables that helps in identifying and evaluating the different sub-attributes and their respective attributes of the tourist destination.

*Inherited resources* - It is the attribute that measures the attractive power of a destination by describing the basic elements of its attractiveness. Components of this attribute do constitute the basic reasons why tourists choose a destination vs. another. They do represent historical sites, heritage, traditional art, flora and fauna, artistic and architectural features, the nature, natural parks, the climate.

*Created resources* – This attribute category provides the basis of creating a successful tourism. These are additional elements of inherited resources which have an important role in improving the position of the destination. The key variables or sub-attributes included in this category are as follows: nightlife, special events/festivals, food service facilities, resorts/spa-s, winter activities, diversity of "shopping" experience, rural tourism, recreation, natural based activities, conference tourism, community support, sports facilities, transport efficiency, casinos, adventure activities, accommodation, facilities for recreation, tourism guides and information, quality and efficiency of airport, entertainment parks, visitor access to natural environments, water-based activities.

*Supporting factors and resources* – residents' hospitality, exchange facilities and financial institutions, telecommunication system, the behaviour of customs and immigration officials, the quality of the tourism sector, communication and confidence relations between residents and visitors, health service facilities for tourists, access to the destination, the destination ties with markets of origin, the visa requirements.

*Destination management* – Group of factors that focuses on managing effectively the inherited and created resources, and supporting factors to increase their attractive abilities toward the tourists. This group of factors contributes at the same time to increase the attraction, the quality and effectiveness of all the other factors, thus creating the most direct mechanism for managing the destination's competitiveness and sustainability. Sub- factors under this category are as follows: the importance of services quality, clear policies of destination toward social tourism, destination vision reflecting residents, visitors and interest groups values; developing effective destination brands; education structure of tourism sector employees; tourist firms efficiency; quality of local tourist entrepreneurship; availability of proper education programs on tourism field; increase of FDI in tourism sector; government cooperation in tourism policies development; commitment of private sectors to the education in tourism field.

*Demand conditions* - includes three elements of tourism demand which are: the information, the perceptions and preferences of the tourists. They can be found under variables like: the compatibility level of the product features with the tourist preferences; international awareness of destination products; general image of the destination; international awareness of the destination.

*Situational factors* represent the situational factors which may moderate or smooth the destination competitiveness. Among these factors may be mentioned location, micro and macro environment, safety, price competition. Variables which can indicate this category of factors may be as follows: the collaboration between private and public sectors; environmental investments; managers' abilities; politic stability; visitors security; e-commerce usage; information technology usage by companies.

### **About Model Application**

The instrument which makes possible the application of Dwyer and Kim model in practise is the questionnaire, which must be composed by taking in consideration the wide inclusion of six factors categories and their 85 sub-factors, by synthetizing and adapting them to different objectives, nature and context of a research study.

In order to gather data on the relative importance of attributes the questionnaire must be addressed to the groups of experts and not to the tourist themselves since they cannot evaluate more than what they consume in a tourist destination and not what entirely offers.

In general there are two groups of experts to whom the questionnaire is addressed. First group is that of managers of destination management organisations like: national tourism administration, public and private tourist offices, and regional tourist organisations. While, the second group of experts are that of researchers and scientists of destination management and marketing field.

Experts will judge and evaluate on the importance of each attribute and sub-attribute of the questionnaire, according to a given points scale chosen. The data gathered after completing the questionnaires, will be processed by different statistical and ranking technics. The information obtained finally will show the relative importance of the attributes and sub-attributes of a destination or destinations under comparison process (if the aim of the research is that. )

### **Some Cases of Dwyer and Kim Model Application**

Vodeb (2010), analyzed the tourist destination competitiveness of 7 cross border areas between Croatia and Slovenia, by using the extended model of Crouch and Ritchie. His research focused on tourism supply providers in the border regions of Slovenia and Croatia aiming to assess their attitudes on tourism, regional competitiveness, and potential tourism destinations as the outcome of cooperation between the two countries, by offering integrated tourist products. To analyze the providers' attitudes, a questionnaire of 41 questions and sub-questions and 65 variables was addressed to a group of experts. The experts had to evaluate the tourism quality according to a ranking system of five scale points, from 1 to 5. The method used to analyze the fact that if the cooperation between the two countries would increase the destinations competitiveness was that of factorial analyses.

*Armenski Tanja, Marković Vladimir* (2011), analysed Serbian destination competitiveness as a tourist destination in comparison with its main competitors. The aim of this research was to determine the weakest and strongest points of Serbian destination, in order to improve those conditions which would be the resources of future and sustainable competitive advantages of this destination. The destination competitiveness in this case was analyzed and evaluated through the integrated model of Dwyer and Kim, by taking in consideration the tourist demand side and supply side factors. The researchers used the experts' judges of tourism field to evaluate and rank the importance of Serbia destination competitiveness factors. After that, the data obtained were processed by Paired Sample Test, in order to have the relative importance ranking of all the attributes and sub-attributes. , which shows how the factors stands in front of each other and on the other hand the main competitors stands in front of Serbia related to each competitiveness factor. The results showed that Serbia is more competitive in its natural, cultural and created resources than in destination management while,

---

according to the Integrated model, Serbia is less competitive in demand conditions that refer to the image and awareness of the destination itself.

## Conclusions

The integrated model of Dwyer and Kim, do offer the necessary structure to evaluate the destination competitiveness by fulfilling the criteria of sustainability and long term effects towards the standard of living and life quality of the residents.

This model offers the most complete structure to be used in comparing destinations and evaluating relative importance of different attributes since it includes all the factors of the demand and supply side of tourism products of a destination. The way the attributes are categorized is very useful and significant for further analyses and evaluations of destination competitiveness perspectives.

However, this models has some of its limits as follows: 1) There can be more than 85 sub-attributes to a destination and their aggregation within 6 categories of attributes becomes difficult; 2) Many of the attributes are measured in a qualitative manner, multi-dimensional, abstract and inaccurate way; 3) Finding data for each attribute is difficult, since some of the data either do not exist or are unreliable; 4) Measurement of the dependent variable as the destination competitiveness is also problematic.

## REFERENCES

- Goffi, Gianluca - Tourism destination competitiveness: theoretical models and empirical evidence. Università Politecnica delle Marche, Doctoral Thesis, 2011/2012.
- T. Armenski, D. Gomezelj, B. Djurdjev, N. Č, and A. D (2012). Tourism destination competitiveness - between two flags. *Economic Research - Ekonomska istraživanja*, Vol. 25 (2012) No. 2 (485-502).
- Dwyer, Larry and Kim, Chulwon. (2003). Destination competitiveness: A Model and Determinants. *Current Issues in Tourism* 6, 369-414.
- A. Tanja, M. Vladimir, D. N and A, J. Tamara (2011). A Integrated Model of Destination Competitiveness. *Geographica Pannonica*, Volume 15, Issue 2, 58-69.
- Vodeb, Ksenija, Cross-Border Regions as Potential Tourist Destinations Along the Slovene Croatian Frontier (November 5, 2010). *Tourism & Hospitality Management*, Vol. 16, No. 2, 2010.
- HASSAN, S. S. , 2000. Determinants of market competitiveness in an environmentally sustainable tourism industry. *Journal of Travel Research*, 38 (3), pp. 239-245.

---

## Comparative Study in Central and Eastern Europe Regarding Restitution/Compensation Process

Ph. D. Cand. Saida Bejtja

Aleksander Xhuvani” University, Faculty of Economics, Department of The right, Elbasan, Albania. E mail: saida.muca@live.com

Ph. D. Cand. Dritan Bejtja

“Aleksander Xhuvani” University, Faculty of Economics, Department of Business -Administration, Elbasan, Albania. E mail: dbejtja@live.com

### Abstract

*The aim of this paper is to analyze the transformations that occurred in the area of private property ownership following the change of political regime in former socialist or communist countries. The six countries looked at are: Albania, Bulgaria, Croatia, Romania and Serbia. These countries illustrate well the whole range of contentious problems in a region where the Communist regimes have varied tremendously in their approach to private property, intensity of social control, repression and overall legitimacy. This diversity of situations poses today different types of dilemmas for the property restitution process, dilemmas which are approached by each country in a different manner. The main question for the countries is how an emerging democracy can “respond to public demands for redress of the legitimate grievances of some without creating new injustices for others.” Moreover, property rights and transparency represent the very bases of a functioning market economy: each of the countries faces the difficult task of finding a balance between remedying violations of property rights and guaranteeing a functioning land market, which enables or will enable full freedom of movement of capital in the EU. There are a number of fundamental difficulties and dilemmas regarding nationalization and restitution/compensation policies in the post-Communist governments in Albania, Bulgaria, Romania and the Western Balkans had to face.*

**Keywords:** property, restitution, rights, dilemmas, process.

### Country-by-Country Summary of Property Restitution in Central and Eastern Europe

#### *Albania Immovable property Rights Reform in the 1990s*

*The concept of private property ownership was revived in Albania after the fall of communism through a broad, but inconsistent, privatization process.*

Prior to World War II, much of the immovable property in Albania was privately owned and included in an indigenous land registry established in the 1930s. All immovable property was progressively nationalized under communism. In 1991, the newly elected parliament reintroduced private immovable property ownership and reactivated the immovable property registry. Particularly important was the 1991 Law On Land, under which agricultural lands were divided among those working them and their families—some two-thirds of the population in total. All former cooperative farms were distributed as part of this process, although the details of implementation varied from region to region. This uneven approach gave rise to frequent disputes, which the local authorities were typically unable to resolve. Ineffective law enforcement increasingly led the population to question the authority of the state and the law. In urban areas, a 1992 Law On Privatization of State-Owned Housing ensured that occupiers obtained ownership of their homes. Some 440,000 apartments and houses were privatized under this law. Table 1 provides a summary of key legislation on property rights in Albania.

**Table 1: Brief Chronology of Immovable property Rights Reforms**

Early 1990s	<p><b>Immovable property privatization</b></p> <ul style="list-style-type: none"> <li>• Law No. 7501 of July 19, 1991, <b>On Land</b>, under which agricultural lands were divided among those working them.</li> <li>• Law No. 7652 of December 23, 1992, <b>On Privatization of State-Owned Housing</b> transferred to occupiers ownership of their homes.</li> <li>• Law No. 7698 of April 15, 1993, <b>On Restitution and Compensation to Former Property Owners</b> was the basis for further privatization in urban areas.</li> </ul>
Mid-1990s	Civil law reform, particularly under the <b>Civil Code of 1994</b> , provided a legal framework for private property transactions.
1995	Law No. 7843 of July 13, 1994, <b>On the Immovable Property Registry System</b> .
1998	<b>Constitution</b> adopted, including provisions guaranteeing immovable property rights.
2004	Law No. 9404 of October 29, 2004, <b>On Legalization and Urban Planning of Informal Zones</b> attempts to regularize illegal buildings based on a self-declaration process managed by local authorities.
2004	Law No. 9235 of July 29, 2004, <b>On Restitution and Compensation of Property</b> replaces the 1993 law and introduces <b>compensation at current market value</b> .
2006	Law No. 9482 of April 3, 2006, <b>On Legalization, Urban Planning and Integration of Illegal Constructions</b> replaces the 2004 law and attempts to regularize illegal settlement and buildings constructed before May 2006, subject to a self-declaration process managed by the central Agency for the Legalization, Urban Planning, and Integration of Informal Areas/Constructions (ALUIZNI).
2007	Law No. 9780 of July 16, 2007, <b>On Construction Inspection</b> delegates much of the responsibility for dealing with illegal buildings to the local government.
2009	1. Law No.10119 of April 23, 2009, <b>On Territorial Planning</b> introduces modern concepts of urban planning and control. The secondary regulations were adopted in June 2011. <b>Amendments to the Law on Legalization</b> , adopted in October 2009, give legalization applicants the option of paying for up to 50 percent of the value of the property with otherwise worthless privatization vouchers from the 1990s.

**The first step in introducing a modern property registration system was taken in 1994, but the process of first property registration remains incomplete.**

The Law on the Registration of Immovable Property adopted in 1994 provides for a modern, parcel-based registration system, and established a dedicated agency, the Immovable Property Registration Office (IPRO) for managing this process. Since then, various donor-sponsored projects have worked to register immovable property in a systematic manner, including the World Bank-financed Land Administration and Management Project (LAMP). Due to the lack of a nationwide effort aimed at systematic first registration, IPRO now estimates that it has records for some 60–70 percent of all properties. IPRO has completed first registration for 83 percent of rural cadastral zones, but only 25 percent of urban cadastral zones. As a result, most properties in urban areas still remain unregistered, though first registration in these areas is currently underway with support from the LAMP.

**It is estimated that some 350,000 to 400,000 buildings have been erected without permits nationwide.**

Rapid internal migration during the economically turbulent, yet less restrictive, 1990s led to mass squatting on state and private land—especially in coastal and periurban areas. No official mechanism existed to allocate land for such large numbers of migrants, so people simply occupied land and started to build. Land was carved up informally, but much of it remained classified as agricultural land and thus ineligible for construction permits. Construction took place without regard for planning or building laws, without official approvals, without proper infrastructure, and often (but not always) on land that



did not belong to the builder. As a result, many urban properties are regarded as illegal. The lack of effective planning and construction controls facilitated additions and expansions of existing constructions that are now also considered illegal. Illegal constructions are estimated to make up one-third of the total housing stock and to have cost some €10 billion to build. Approximately one-third of the land on which illegal buildings have been constructed belongs to the builders, one-third to the state, and one-third to another person, such as an owner whose property was restored or a person who received land under the 1991 Law On Land. Table 2 outlines circumstances that result in illegal status. The institutional structure for property rights in Albania is laid out in Table 3.

**Table 2: Status of Properties in Albania**

Status	Issues	Consequences
Registered property with clear title and boundaries	Property is registered at IPRO without restriction and boundaries are not in dispute	Registered property may be sold, mortgaged, or receive compensation in case of expropriation; may be sold at about a 10 percent higher price than an equivalent property without registration or with unclear title. Law offers protection.
<b>Unregistered property</b> with clear title and boundaries	Documentary proof of ownership exists and boundaries are not disputed, but property is not registered at IPRO	Cannot be mortgaged, difficulties in expropriation (has to be registered first), unappealing to foreigners, notaries not involved in sale. Property can be registered subject to applicable fees and legal costs.
Registered property with <b>unclear title</b>	Some problems or uncertainty exist regarding legal rights, such as missing documents	Requires effort and costs to resolve problem, possibly court case. Some difficulties in mortgaging, selling.
<b>Unregistered property with unclear title</b> (or boundaries)	Property could not be registered due to uncertain ownership	Requires effort and costs to resolve problem, possibly court case, plus costs of registration. Cannot be mortgaged; difficulties in expropriation; more difficult to sell, especially to foreign buyers; notaries not involved in sale.
Land occupied by squatters and illegally built on, but <b>successfully legalized</b>	After legalization by ALUIZNI and title registration at IPRO, property has the same status as registered property with clear title and boundaries	Same as for registered property with clear title; during the legalization process, legal protection unclear (e.g., in case of expropriation, as property needs to be registered first).
Land (registered or not) with <b>illegal building</b>	Occupier is legal owner of land (may nor may not be registered) but building does not have construction permit; or building does not comply with terms of construction permit (for example, has additional floors)	Owner at risk of having building demolished; problems with expropriation, sale; property cannot be mortgaged if land is not registered.
Land belonging to a different owner (registered or not) and <b>illegally occupied by squatters</b> ; not part of the legalization process	Mass migration resulted in large-scale occupation of land and construction without legal title or planning permit; not all occupiers have applied for legalization;  some properties are not eligible for legalization (including land in designated natural reserves)	Least secure category: owner is at risk of eviction or demolition of building. Property cannot be mortgaged or legally transferred; no legal protection in case of expropriation.

**Table 3: Key Institutional Actors on Property Rights**

Organization/Agency	Mandate
<b>IPRO</b>	To register immovable property, transaction documents, and changes to boundaries, and to supply data to the public
<b>ALUIZNI</b>	To coordinate with planning authorities on the introduction of illegal buildings into urban plans and to grant ownership of occupied land to squatters who are legalizing their building
<b>AKKP</b>	To manage the restitution of land or provide compensation in cash or through alternate properties or other means
<b>Municipalities and Communes</b>	To develop and issue urban plans and approve projects up to 5,000 square meters
<b>National Council for Territorial Adjustment</b>	To develop and issue plans at the national level and approve projects larger than 5,000 square meters
<b>Construction Police</b> (national and local level)	To investigate, fine offenders, and take remedial action, such as demolishing structures

**The current problems are not intractable and can be addressed through a coherent policy aimed at a comprehensive and pragmatic solution, based on broad political and societal support.**

Such a solution would need to address some important inconsistencies and gaps in the existing legal framework to remove current bottlenecks holding back the key processes of title registration, legalization, and restitution and compensation. In particular, a policy solution whereby a greater share of the cost of compensation would originate from beneficiaries of expropriation (such as legalization applicants) would likely be more sustainable, both in terms of fiscal affordability and perceived fairness. An acceleration in the payment of compensation to expropriated owners is urgently needed to ensure credibility of the law, stem the flow of legal challenges, and remove obstacles to the completion of the legalization process. At the same time, this may require revisiting the legal provision to pay compensation at current market values, which is not in line with international practice. A comprehensive solution will also need to consider the status of a large number of informal properties that currently remain outside the legalization process and clarify the legal rights of legalization applicants while the process is ongoing. An open debate with the active participation of all stakeholders and civil society at large will be instrumental to finding a viable solution that is seen as legitimate, equitable, and sustainable over the longer term. The Government's Action Plan for the Resolution of Property Rights Issues, which was adopted in April 2011, aims to accelerate the payment of compensation to restitution claimants and address related aspects of the legalization and title registration processes. While the Action Plan represents a positive step toward a policy debate on a sustainable solution, a comprehensive Strategy still remains to be prepared.

**A successful solution will also require a strong focus on ensuring effective and consistent implementation of policies and laws.**

In this regard, the Government will need to continue its efforts to further strengthen the capacity of IPRO and seek to speed up the systematic completion of first registration in urban centers and other economically significant areas to improve the validity of IPRO records. It will also be important for the Government to act with determination to enhance coordination among IPRO, ALUIZNI, and AKKP, possibly by amalgamating these agencies or subordinating them to the supervision of a single cabinet member. Indeed, the Government's Action Plan of April 2011 foresees a new coordination mechanism. At a minimum, it will be necessary to ensure the full compatibility between these agencies data, information requirements, and procedures. Finally both the Government and civil society will need to loosely monitor the effective and consistent implementation of the new Urban Planning Law as well as municipal authorities' practices in issuance of construction permits, which have hitherto been fraught with uncertainties and corruption opportunities.

### **Bulgaria**

- Most private property claims have been settled.

- A Government Commission made recommendations in 2006 to resolve outstanding communal property claims.

### Private Property

Bulgaria was one of the first Eastern European countries to pass private property restitution legislation. In contrast to other former communist countries, Bulgaria did not generally nationalize land, but instead nationalized businesses using the land while owners retained title to the land itself. Current restitution law stipulates that both Bulgarian citizens and non-Bulgarian citizens are eligible to receive property confiscated during the fascist and communist periods. A successful claimant who is not a Bulgarian citizen, however, must sell the property. Only Bulgarian citizens can receive restituted forest and farmland. Most private property claims have been resolved.

### Communal Property

NGOs and certain denominations, including the Bulgarian Orthodox Church, the Catholic Church, the Muslim community, the Jewish community, and several Protestant churches, claim that a number of communal properties confiscated under the communist government have not been returned. In this category is a Muslim community claim for at least 17 properties. The Catholic Church claims six buildings in Sofia, three buildings in Plovdiv, several buildings in other towns, and three monasteries. In addition, the government reportedly retains properties of several Protestant groups. The Congregational Church, for example, has an ongoing dispute with the municipality over a building in Plovdiv.

In the spring of 2006, the Government appointed a commission to examine the status of several properties claimed by Shalom, the Bulgarian Jewish community organization. These properties had been under discussion between Shalom and the Government for more than a decade. One property that was not on the commission's agenda was the property on which the Rila Hotel is situated. A court ruling in early 2006 rejected the long-contested claim of the Bulgarian Jewish Organization, Shalom.

In regard to the other properties claimed by Shalom, the Commission recommended that alternate property be identified to turn over to Shalom to replace a synagogue and rabbi's residence in Varna. With respect to a Sofia hospital restituted to Shalom in 1997 and leased to a state hospital, the Commission suggested speeding the process of finding suitable quarters for the hospital and transferring six rooms of the existing hospital to Shalom. Despite the Government's recommendation, however, the hospital's management, which ceased rental payment in 2002, has neither transferred the rooms to Shalom nor has it agreed to a date for vacating the premises in the future.

In 2003, the government restituted to Shalom all but the top two floors of the building at 9 Saborna Street in Sofia. After confiscating the building, the government added the top two floors, which were therefore not eligible for restitution. In 2007, the government decided to gift the top two floors to Shalom.

A central problem facing all claimants of communal property is the need to demonstrate that the claiming organization (or its legitimate successor) is the organization that owned the property prior to September 9, 1944. Destruction of records during the war and the effort by some groups to conceal ownership of assets because of communist hostility to religion have complicated the documentation of ownership.

### Croatia

- Stalled legislation slows pace of private property restitution.
- Communal property claims remain largely unresolved.

### Private Property

Due to Croatia's turbulent past, there is a large amount of disputed property throughout the country. Croatia passed a property restitution law in 1990, and subsequently amended that law in 1991 and 1993. Implementation of the law continues to proceed very slowly.

The 1996 "Law on Restitution/Compensation of Property Taken during the Time of the Yugoslav Communist Government" prohibited non-Croatian citizens from making claims. But in a 1999 ruling, the Constitutional Court struck down six clauses deemed to discriminate against foreigners. After a long delay, the Croatian parliament in July 2002 amended the law to extend to foreigners the right to claim nationalized property or receive compensation, provided that Croatia and the claimant's home country have concluded a bilateral agreement on the issue. The amended law pertains to the communist era only and not to the 1941-45 period of rule by the Nazi-allied Ustashe regime, nor to the period of civil unrest after the breakup of Yugoslavia.

The law initially created a six-month period from July 2002 until January 2003 in which non-Croatian citizens were eligible to file claims. Croatia subsequently waived that deadline after determining that it does not have an appropriate bilateral agreement with the U. S. or any other country that would allow non-Croatian citizens to file claims. The government did not provide any official response to U. S. requests during 2004 and 2005 to negotiate such an agreement. In late 2005, Croatia concluded an agreement with Austria that would have enabled Austrian citizens to apply for property restitution. That agreement was not submitted for ratification.

In early 2006, the Croatian government informed the U. S. Embassy that Croatia had decided it would not pursue further bilateral agreements. At that time the Croatian government instead proposed amending the 1996 law in order to allow foreigners to file claims under the Act's provisions without the need for a bilateral or international agreement governing the issue. Under the amendment, foreigners would be given a six month period to file claims, and the law would allow the inclusion of claims for property taken as early as 1941. As of September 2007, that amendment had not yet moved forward in Croatia's parliament, leaving non-Croatians still unable to apply for restitution under the 1996 law.

A number of individuals, who were not U. S. citizens when their claims against Croatia arose but have since become American citizens, are among those foreigners with outstanding property claims.

Two previous U. S. -Yugoslav settlement agreements compensated many claims by American citizens. The first agreement pertained to property expropriated between 1939 and 1948. The second agreement, entitled the "Agreement between the USG and SFRY Regarding Claims of US Nationals", became effective on January 20, 1965 and covered the years from 1948 to 1964. Both agreements applied to claimants who were U. S. nationals at the time the property was seized. The claims process under these two agreements ended in the 1960s.

The issuance of permits by local governments for construction on land with disputed titles complicates the restitution process.

### **Communal Property**

The government has worked separately with the various religious communities to resolve communal property restitution issues. Usually agreements between the government and the individual communities govern the communal property restitution process. So far, agreements have been signed with the Catholic, Serbian Orthodox, and Muslim communities, but not with the Jewish and Baptist communities. The government maintains that 19 percent of all communal property restitution claims have been resolved.

The government employs three methods to reconstitute communal property to religious communities: natural restitution (in rem restitution of the actual property that was taken), replacement restitution (transfer of like-kind property when the original property cannot be restituted), and monetary compensation.

Of all the religious communities, the Catholic Church is the largest holder of property. In 1998, the government signed a concordat with the Vatican that provided for the return of all Catholic Church property confiscated by the communist regime after 1945. This agreement stipulates that the government would return seized properties or compensate the Church where return is impossible. Some returnable properties have been restituted, but there has been no compensation to date for non-

returnable properties. In April 2003, the Catholic Church specifically requested the restitution of 43 properties, but three years later only a few of those properties had been restituted. Many claims met resistance from local authorities.

In exchange for nationalized property, the Church took over a former hospital building in Osijek in June 2004 and in September it renounced claims on its building used by the University in Rijeka in exchange for another University building. In 2006, the Roman Catholic Church received eight separate properties in restitution proceedings. A Government offer of a 25 percent stake in the Croatia Osiguranje insurance company as compensation for unreturned property remains under negotiation.

The Serbian Orthodox (SPC) community filed hundreds of requests for the return of seized properties, but the community has received only ten percent of what it claimed. An agreement between the Orthodox community and the government established a commission to address property claims. Several properties at issue in Zagreb are the subject of court cases, which take many years to adjudicate. In 2004 one building in Karlovac was returned, which housed County offices. Return of forests and arable land is particularly slow.

The Serbian Orthodox Church held three meetings with government representatives on restitution issues in 2007 but the results were minimal. Early in 2007 Metropolitan Jovan Pavlovic asked both the U. N. High Commissioner for Refugees and the Organization for Security and Cooperation in Europe to propose changes to the 1996 property restitution law. No further action has been taken.

SPC officials were particularly concerned about the lack of progress in restitution of several valuable business and residential buildings in downtown Zagreb, most notably the Zagreb Cinema building and several apartments which have been the subject of contentious legal proceedings, some undeveloped land, as well as some arable land and forests. .

The Jewish community in Croatia before World War II numbered approximately 35,000 to 45,000. Some 6,000 Croatian Jews survived the war, and the community now has about 2000 members, more than half of whom live in Zagreb. Although Jewish groups in Croatia have received some of their claimed property in Zagreb, several outstanding claims remain. For example, land in Vukovar where a synagogue was once located has been returned to the Jewish community, but an estimated 20 additional Jewish property claims are still pending throughout the country. The Jewish community is in the process of negotiating an agreement with the government to address property restitution, and other issues. The Jewish community reported that the processing of its claims for nationalized property has made no progress since 2005, with the exception of the 2007 return of a commercial property in Osijek. Other claims remained stalled in court.

The Muslim community of approximately 60,000 has not filed any claims. It is not clear whether the Protestant churches have claimed any property.

## **Romania**

- Implementation of Law 10/2001 (private property) continues at a slow pace.
- Implementation of Law 501/2002 (religious property) and Law 66/2004 (communal property) began late, and is proceeding slowly.
- Property fund not yet operational.
- Greek Catholic Church claims remain unresolved.

## **Private Property**

Romania did not pass formal property restitution legislation until 2001 for urban dwellings (legislation was passed regarding farm and forest lands in 1991 and 2000, respectively). For the first decade following the fall of the Ceausescu regime, a series of court decisions, laws and decrees governed the return of property seized during World War II and under communist rule. These decisions, laws and decrees were frequently contradictory and led to considerable confusion.

In February 2001, Romania enacted Law 10 to govern private property restitution for properties confiscated during the 1945-1989 period. While this law provides a systematic approach to private property restitution, it is complex and places a considerable burden on claimants. Initially, the law provided an application period of just six months. There was no notification program outside of Romania, so potential claimants found it difficult to learn about the application process.

At the suggestion of the United States, the Romanian government extended the deadline, first to November 2001 and then to February 14, 2002. But the overseas notification program was not implemented until late 2001, making it hard for claimants to meet the application deadline. Law 10 does not allow for the restitution of agricultural or forested properties, which were covered by laws 18/1991 and 1/2000. Nor does Law 10 cover the restitution of properties belonging to religious communities or minority groups. Article 16 of Law 10, which exempted properties used for public purposes (such as hospitals, schools, kindergartens, theaters, museums, and other such institutions) from restitution *in rem*, was amended by Law 247/2005 to allow the restitution of such buildings. The rightful owners have the obligation to let public and cultural institutions use the buildings as tenants for three years, and health care and educational institutions for five years, after the restitution of the buildings. The owners are exempted from property taxes during this period and receive rent.

Law 10 required that applicants submit claims to municipal authorities through a court having jurisdiction over the property in question. This made it difficult for applicants who left Romania at an early age or for heirs to know where to submit applications. Despite these hindrances, about 202,000 claims were filed; of these, 120,000 claimants requested restitution in kind and 82,000 requested financial compensation or other reparation measures. Only 38,400 applications were completely documented. The National Authority for Property Restitution (ANRP) reported that approximately 97,000 claims had been resolved by mid-2007.

The deadline for documenting claims was extended from February 14 to July 1, 2003. In May 2003, the government published reformulated implementing regulations. The late publication gave applicants little time to comply prior to the July 1 deadline. These regulations provide that individuals who "sold" their property to the communist-era government in order to emigrate would not be compensated. Claimants also had to submit official documentation showing that they did not receive any compensation under prior claims agreements (such as the 1955 and 1963 U. S. -Romania Claims agreements).

In July 2005, the Romanian government passed Law 247 aimed at improving the property restitution process, clarifying and simplifying procedures, establishing new deadlines for submitting applications for the restitution of religious and communal property (January 25, 2006), as well as of farm and forest land (November 30, 2005), and fines for officials who hindered the process. The 2005 law eliminated some of the flaws of earlier property restitution legislation that were repeatedly criticized, e. g. , among others, it permits the restitution of land on which now demolished buildings once stood, and provides for compensation.

Law 247/2005 amended all the existing restitution laws, i. e. law 10/2001, law 501/2002, law 66/2004, and the land restitution laws.

Law 247/2005 eliminated the deadline (originally July 1, 2003) for the submission of documents supporting the applicant's claim. Claimants can continuously submit newly obtained documents and proof of ownership until a case is resolved.

Law 247/2005 also created a fund equivalent to Euros 4 billion (\$5. 3 billion) in registered capital to compensate owners whose property cannot be returned. Payment for property that cannot be restituted will be in the form of shares in a government-supervised investment fund comprising 114 companies. As of September 2007, 2,457 claimants had received shares. These shares, however, cannot yet be legally traded. As of September 2007, some 97% of the fund was still owned by the state.

On June 28, 2007, the government adopted an ordinance that should enable the fund to be evaluated and then listed on the stock exchange by mid-2008. The ordinance also provides for cash payments in lieu of restitution of up to about \$215,000 (500,000 new lei), paid over a two-year period. Larger claims are to be paid with stock in the property fund. Other steps that have been scheduled for 2007 are the assessment of the stock comprising the Fund's portfolio and, perhaps most importantly, the selection of a firm with an international reputation to manage the Fund. At the end of 2006, 31 different international firms were interested in becoming the Fund manager.

Former owners criticize the Property Fund as being only a means to delay further the compensation of property seized under communist rule.

It is not clear how long it will take to adjudicate claims or how transparent that process will be. Claimants reported that local officials are reluctant to provide necessary documents and frequently delay or refuse to turn over properties in which local governments had an interest. Furthermore, some mayors charged with adjudicating claims were reported to be pushing claimants to accept shares in the fund instead of *in rem* restitution in order to avoid the political and administrative difficulties

associated with displacing current occupants. There were also complaints that the central government was inconsistent in imposing fines and other sanctions in such cases.

In numerous Romanian property restitution cases over the past several years, the European Court of Human Rights has ruled in favor of the former owners. There were at least eight such cases in the first five months of 2007. In each case, the Court has ordered the Romanian state to pay sizeable damages unless the buildings in question were returned.

### Communal Property

In late June 2002, Parliament approved Law 501/2002 governing the restitution of property to religious organizations. The law covers buildings (such as schools and hospitals, but not houses of worship) that the State confiscated from religious groups between March 6, 1945 and December 22, 1989. It did not cover the period between 1940 and 1945, when large numbers of Jewish properties were seized, nor does it cover the restitution of Greek Catholic churches confiscated by the former communist regime and now held by the Romanian Orthodox Church. Unlike Law 10, it covers only buildings that still exist and does not provide compensation for buildings that were demolished. Under Law 501/2002, religious denominations had requested restitution of 7,568 properties by the original March 2, 2003 deadline. By the time the extended filing period (January 25, 2006) lapsed, the number of applications reached 14,716, broken down as follows:

Orthodox Church	2,215
Roman-Catholic Church	1,203
Greek Catholic Church	6,723
Reformed Church	1,208
Jewish faith	1,918
Evangelical Church	1,133
Other denominations	303

Under Law 501/2002, by the middle of 2007, the Special Commission for Restitution had restituted 599 of the 1700 buildings claimed by Hungarian churches. However, the Hungarian churches were not able to regain physical possession of many of these properties.

A foundation established by the Federation of Jewish Communities in Romania and the World Jewish Restitution Organization to follow restitution issues has received approximately 42 properties, restituted by the four government acts passed between 1997 and 2000. The Jewish community was able to take actual possession of only 36 of them. Documenting ownership has been difficult for the foundation because of the lack of access to archives. As of mid-2007, the Jewish community had received only 51 of the 1,918 properties claimed under Law 501. For 16 other properties, the Jewish community will receive compensation. In addition, under Laws 18/1991 and 1/2000, the Jewish community received 15 pieces of land in Iasi (sites of former synagogues and schools). Three additional plots were returned to the Jewish community in 2005 and 2006, but 18 other land claims remained unresolved.

In March 2004, Parliament adopted Law 66 covering the restitution of properties that belonged to ethnic communities and were confiscated between September 6, 1940 and December 22, 1989. Confiscation between 1940 and 1945 was included at the suggestion of the Jewish community. By the filing deadline-which was extended to January 25, 2006-2,154 claims were filed, 1,856 by the Jewish community alone. As with Law 502, there is no provision for compensation for demolished buildings. Actual restitution under this law began in 2006 and 156 claims were resolved by June 1, 2007.

A 1990 government decree established a joint Orthodox and Greek Catholic committee to address the issue of former Greek Catholic churches. The committee met only sporadically in the 1990s and its work has been at a virtual standstill

since 2004. There were 2600 properties (churches and monasteries) on the original list of Greek Catholic claims. By the middle of 2005, the Greek Catholic Church had reduced its claims to fewer than 300. The Greek Catholics report that only 16 churches have been restituted as a result of the joint committee's work. The Orthodox Church has continued to demolish Greek Catholic churches under various pretexts.

Of the 6,723 properties claimed by the Greek Catholics under Law 501/2002, 103 had been returned by mid-2007. In eight other cases, the Greek Catholic Church will receive compensation. Since 1989, fewer than 200 churches have been returned to the Greek Catholics. The Greek Catholic Church, however, did obtain an important cathedral in Oradea in November 2005 with the help of interventions from the Prime Minister and the Minister of Culture and Religious Affairs, and a cathedral in Satu Mare in February 2006, after 16 years of lawsuits.

Lawsuits and protests by current occupants have impeded the restitution of many properties to their rightful owners.

### **Serbia:**

- Private property restitution has not begun, pending passage and implementation of necessary laws.
- Communal property restitution law awaits implementation.

### **Private Property**

Many American citizens with claims in Serbia received compensation under two settlement agreements concluded between the United States and Yugoslavia in 1948 and 1965. The 1948 agreement pertained to property expropriated between 1939 and 1948; the 1965 agreement covered property seized between 1948 and 1964. The claims processed under these agreements ended in the 1960s. Under these agreements, the Socialist Federal Republic of Yugoslavia (SFRY) paid a total of \$20.5 million. The two agreements do not hold Yugoslavia or its successor states harmless from additional claims of current American citizens. The agreements provided access to settlement to claimants who were American citizens at the time their property was taken. Under Serbian law, heirless property reverts to the state.

The military conflict of the 1990s delayed consideration of property restitution legislation in many of the former Yugoslav republics. Serbia does not yet have restitution legislation. However, a law providing for the registration of potential claims went into effect on June 8, 2005. The law covers property taken through confiscation, nationalization, agrarian reform, sequestration, expropriation and other regulations that became effective after March 9, 1945. The legislation set a June 30, 2006 registration deadline, and allowed deprived owners, their legal inheritors or legal successors to register claims. According to the law, registering a claim for seized property does not represent a request for restitution or compensation for that property. The Embassy is concerned that the 1945 date may disadvantage Jewish claimants who generally had property seized prior to that date, and Jewish and Muslim groups have opposed this benchmark.

The most recent proposed draft law to govern the restitution of private property was presented by the interim government in May 2007, but was not accepted by the current administration. A Serbian government working group will begin revising that latest proposed draft law in early autumn 2007. The draft presented in the spring provides for regional commissions to adjudicate claims, awarding *in rem* restitution when possible and compensation in marketable bonds if the property is being used for a public purpose or has been purchased in good faith by an individual. Bond compensation would be limited to Euros 1 million per claimant and 1 million per property. The proposed draft law also provides for consideration of claims dating back to April 6, 1941. A number of claimants have objected to compensation in the form of bonds, the limit of Euros 1 million per claimant, as well as a number of other provisions in the draft law.

In addition to considering the various objections and suggested modifications to the latest draft, the government working group is also contemplating breaking the current proposed draft law into two separate laws: one on privatization of urban construction land and the other on general denationalization. Both could be approved by the end of the year in the most optimistic estimates.

The Finance Minister has publicly estimated the value of nationalized property in Serbia at between \$60 billion and \$150 billion, a daunting amount compared to Serbia's current total public debt of \$13 billion and \$23 billion GDP.



Several U. S. citizens have raised ownership claims on commercial properties that are in the process of being privatized. The American Embassy in Belgrade is aware of 32 potential claims in Serbia involving U. S. citizens. These claimants were not able to benefit from previous legislation and/or bilateral agreements because they were not U. S. citizens when their claims arose. These claimants often accuse the Government of Serbia of delaying a restitution law until claimed assets have been sold.

Serbian officials have expressed concern that restitution would delay completion of privatization. Serbian law provides that 5% of all privatization revenues must be placed in a compensation fund for eventual restitution. The Embassy has raised restitution repeatedly with officials at the municipal, republic and state union levels, urging authorities to move ahead with a fair restitution law. Several EU member state embassies have also become engaged on behalf of their citizens.

### **Communal Property**

In post-WWII Yugoslavia, religious communities were limited to possessing 10 hectares of land or 30 hectares of religious sites of cultural importance. In Serbia, a separate law is to regulate restitution of church and communal property.

In mid-2006, the Serbian National Assembly adopted the Law on Return (Restitution) of Property of Churches and Religious Communities, seeking to expedite the restitution of property to Serbia's religious communities. The law calls for the creation of a Restitution Agency, which will adjudicate claims.

With the exception of the Igumanova Palace, which was returned to the Serbian Orthodox Church by Milosevic as a goodwill gesture, no church properties have been restituted in Serbia.

### **References**

#### 1. Albania

Agency for Restitution and Compensation for Properties, *Report to the Prime Minister*, 16. 10. 2009.

Council of Ministers, *Draft Inter-Sectoral Strategy Reform in the Field of Property Rights*, Tirana, 2009.

European Commission, *Albania, Stabilisation and Association Report 2003*, Brussels, COM (2003) 139 final, 26. 03. 2003  
[http://ec.europa.eu/enlargement/pdf/albania/com03\\_339\\_en.pdf](http://ec.europa.eu/enlargement/pdf/albania/com03_339_en.pdf)

European Commission, *Albania, Stabilisation and Association Report 2004*, Brussels,  
COM (2004) 203 final, [http://ec.europa.eu/enlargement/pdf/albania/cr\\_alb\\_en.pdf](http://ec.europa.eu/enlargement/pdf/albania/cr_alb_en.pdf)

European Commission, *Albania 2005 Progress report*, Brussels, COM (2005) 561 final 09. 11. 2005

[http://ec.europa.eu/enlargement/archives/pdf/key\\_documents/2005/package/sec\\_1421\\_final\\_progress\\_report\\_al\\_en.pdf](http://ec.europa.eu/enlargement/archives/pdf/key_documents/2005/package/sec_1421_final_progress_report_al_en.pdf)

European Commission, *Albania 2006 Progress Report*, Brussels, COM (2006) 649 final, 08. 11. 2006  
[http://ec.europa.eu/enlargement/pdf/key\\_documents/2006/nov/al\\_sec\\_1383\\_en.pdf](http://ec.europa.eu/enlargement/pdf/key_documents/2006/nov/al_sec_1383_en.pdf)

European Commission, *Albania 2007 Progress Report*, Brussels, COM (2007) 663 final, 6. 11. 2007  
[http://ec.europa.eu/enlargement/pdf/key\\_documents/2007/nov/albania\\_progress\\_reports\\_en.pdf](http://ec.europa.eu/enlargement/pdf/key_documents/2007/nov/albania_progress_reports_en.pdf)

European Commission, *Albania 2009 Progress Report*, Brussels, COM (2009) 533 final, 14. 10. 2009,  
[http://ec.europa.eu/enlargement/pdf/key\\_documents/2009/al\\_rapport\\_2009\\_en.pdf](http://ec.europa.eu/enlargement/pdf/key_documents/2009/al_rapport_2009_en.pdf)

Frangakis, N. ; Salamun, M. and Gemi, E. "Property Restitution in Albania", Briefing Paper, Brussels, 2008.

Interview with Mr. Toro, the representative of the Association of expropriated owners "Property through justice", Tirana, 27. 10. 2009

Kelm, K. *Land Administration and Management Project Component A: Security of Tenure and Registration of Immovable Property Rights: Study on Security of Registered Titles in Albania*. World Bank, Tirana, 23 October 2009.

OSCE Presence in Albania. *Commentary on the draft law "On Recognition, Restitution and Compensation of Property"*, presented to the Assembly of the Republic of Albania by OSCE led Technical Expert Group. 27 October 2003.

[http://www.osce.org/documents/pia/2003/11/1434\\_en.pdf](http://www.osce.org/documents/pia/2003/11/1434_en.pdf)

OSCE Presence in Albania. "OSCE Presence in Albania launches database on land restitution and compensation claims". Press release. Tirana, 27 June 2007.

<http://www.osce.org/item/25342.html>

OSCE Presence in Albania, "Property reform" <http://www.osce.org/albania/18643.html>

OSCE Presence in Albania. *Report by the Head of the OSCE Presence in Albania to the*

*OSCE Permanent Council*. October 2009. [http://www.osce.org/documents/pia/2009/10/40893\\_en.pdf](http://www.osce.org/documents/pia/2009/10/40893_en.pdf)

Ministry of Justice. Annual Statistical Book 2008. [http://www.justice.gov.al/UserFiles/File/vjetari/Vjetari\\_Statistikor\\_2008.pdf](http://www.justice.gov.al/UserFiles/File/vjetari/Vjetari_Statistikor_2008.pdf)

## 2. Bulgaria

"Civil wars against each metre of new urban development"

<http://www.segabg.com/online/article.asp?issueid=2972&sectionid=5&id=0001001..>

Gruev, Mihail. Preorani, Slogove. *Kolektivizatsiya i sotsialna promyana v Bulgarskiya severozapad 40-te – 50-te godini na XX vek*. Ciela, Sofia, 2009.

Gyuzeev, Boyan. "Politika i privatizatsiya. Transformatsiya na sobstvenostta v Bulgaria prez prizmata na politicheskite borbi". Centre for the Study of Democracy (CSD), Sofia, 1993.

Helsinki Committee, Watch Report "Destroying Ethnic Identity: The Turks of Bulgaria", September 1987.

"Historic Victory in Agriculture", *Rabotnichesko delo* (official newspaper of the Communist Party) 1959.

Interview with Mr. Ahmed Dogan, leader of the Turkish Ethnic Party MRF, Gledishta newspaper, reprinted in Duma daily on June 13, 1994.

Kamm, Henry "Toll in Bulgaria's Turkish Unrest is put at 100", The New York Times, on Feb. 8 1985

Mateev, B. *Dvizhenieto za kooperativno zemedelie v Bulgariya v usloviyata na kapitalizma*, Sofia. 1967.

Ministry of Agriculture and Food, Annual Report 1999. Available at

<http://www.mzh.government.bg/Article.aspx?lang=1&Imid=421&id=421&mid=0>

Ministry of Agriculture and Food, Annual Report 2000. Available at

<http://www.mzh.government.bg/Article.aspx?Imid=420&id=420&lang=1>

National Statistical Institute. Results from Censuses. Vol. 1: Demographic characteristics. Sofia, 1994.

National Statistical Institute, "Survey on the effects of the 1992 restitution laws". 2000.

OECD, "Report on agriculture in Bulgaria", 2000.

Panayotov, Filip, Nikolova, Ivanka. *Bulgariya 20 vek: Almanakh*, Trud Publ., 1999.

---

"Legal analysis", Praven svyat, <http://www.legalworld.bg/show.php?storyid=10425>. Spasov, Spas. "Clockwork of a Ghetto", Dnevnik, 22 Apr 2007

[http://www.dnevnik.bg/dnevnikplus/2007/08/22/370441\\_geto\\_s\\_chasovnikov\\_mehanizum/](http://www.dnevnik.bg/dnevnikplus/2007/08/22/370441_geto_s_chasovnikov_mehanizum/)

State Privatisation Agency of Bulgaria, "Information on the privatisation process in Bulgaria (by 30. 11. 2009)", available at [www.priv.government.bg](http://www.priv.government.bg)

### 3. Croatia

Gagro B. , "Practice of the Administrative Court of the Republic of Croatia and Uncertainties in the Application of the Law on Restitution /Compensation of Property Taken During the Time of the Yugoslav Communist Government", report for the website

of the Administrative Court,

[http://www.upravnisudrh.hr/praksa/full.php?link=. . /praksanov/referat\\_bg.htm](http://www.upravnisudrh.hr/praksa/full.php?link=. . /praksanov/referat_bg.htm)

Interview with Milanovic, Petra, December 16th, 2009.

Karadjova, M. , "Property Restitution in Eastern Europe: Domestic and International Human Rights Law Responses", *Review of Central and East European Law*, 2004 No. 3,325-363, Koninklijke Brill N. V. ,

[http://web.ebscohost.com/ehost/pdf?vid=5&hid=3&sid=2c53af6c-51ec-41ba-91bb-](http://web.ebscohost.com/ehost/pdf?vid=5&hid=3&sid=2c53af6c-51ec-41ba-91bb-48dfa3f692a5%40sessionmgr103#db=poh&AN=14614001)

[48dfa3f692a5%40sessionmgr103#db=poh&AN=14614001](http://web.ebscohost.com/ehost/pdf?vid=5&hid=3&sid=2c53af6c-51ec-41ba-91bb-48dfa3f692a5%40sessionmgr103#db=poh&AN=14614001)

Karlovcan, Djurović Lj. , "The Law on Restitution /Compensation for Property Taken During the Time of the Yugoslav Communist Government – Practice of the Administrative Court of the Republic of Croatia", *Almanac of the Faculty of Law at University of Rijeka*.

Issue no. 29, March 2008, p. 643 – 679

[http://hrcak.srce.hr/index.php?show=clanak&id\\_clanak\\_jezik=40006](http://hrcak.srce.hr/index.php?show=clanak&id_clanak_jezik=40006)

State Public Prosecutor's Office, *Report on the Work of the Public Prosecutor's Offices for 2007*, [www.dorh.hr](http://www.dorh.hr)

### 4. Romania

Avocatul Poporului, *Annual Report 2008*

Baias, Flavius, Dumitrache Bogdan, Nicolae Marian, *Regimul juridic al imobilelor preluate abuziv. Vol. I: Legea Nr. 10/2001 comentată și adnotată* (The Legal Situation of Nationalised Property. 1st Volume: Law 1/2001 discussed and annotated). Rosetti,

Bucharest, 2001.

Cartwright, Andrew, "Against 'de-collectivisation' land reform in Romania, 1990-1992", Max Planck Institute for Social Anthropology, Working Paper no. 4, Halle/Saale, 2000.

*Comisia Internationala pentru Studierea Holocaustului in Romania - Raport Final*, Polirom 2005.

Constantin, Florentina. *Privatisation of Agriculture in Some East-European Countries (Hungary, Poland, Romania, Bulgaria)*. PhD Thesis, Academy of Economic Studies, Faculty of International Business and Economics, Dept History of Economy and Geography, 2005.

European Commission, *Regular Report from the Commission on Romania's Progress towards Accession, 1999*

European Commission, *Regular Report from the Commission on Romania's Progress towards Accession, 2000*.

European Commission, *Regular Report on Romania's Progress towards Accession, 2001*

European Commission, *Regular Report on Romania's Progress towards Accession, 2003*

ECtHR "The Court Applies the Pilot-Judgement Procedure to Romanian Cases Concerning the Restitution of Properties Nationalised under Communism", press release no 158/25. 02. 2010.

Iancu, G. "Aspecte din procesul colectivizării agriculturii în România (1949-1960)", *Anuarul Institutului de Istorie din Cluj – Napoca*, 2001.

Interview with Damiana Oțoiu, researcher at the Institute for Political Studies of the Bucharest University, author of a PhD thesis (due in March 2010) on restitution of property to the Jewish community in Romania.

Interview with the President of Proprietatea Fund, Bucharest, January 2010. Luca, Lucian. "Sectorul agroalimentar din Romania intr-o perspectiva europeana".

Working Paper 39, World Bank, ECSSD, June 2005, Chap. 4.

SAR, "Restituirea proprietății: De ce a ieșit așa prost în România?". Policy Brief 34, 2008

National Agency for Property Restitution, a response to a request based on Law 544/2001 on free access to public information. The data refer to end of 2009.

Socaciu, E. M. *Problema Dreptatii si Restituirea Proprietatii in Romania Post-comunista*, (The Issue of Justice and Property Restitution in Post-Communist Romania). Doctoral Thesis, University of Bucharest.

Stan, L. "The Roof over our Heads, Property Restitution in Romania", *Journal of Communist Studies and Transition Politics*, Vol. 22, No. 2, June 2006, pp. 180–205, 2006.

Verdery K, 'Seeing like a Mayor, or How Local Officials Obstructed Romanian Land Restitution' *Ethnography*, Vol 3 (1): 5–33, 2002.

World Bank Governance Indicators (1996-2008): <http://info.worldbank.org/governance/wgi/index.asp>

## 5. Serbia

Antic, Miroslav, "Kraj bajke o restituciji", 10 March 2005, <http://www.mailarchive.com/sim@antic.org/msg22508.html>

Avakumović, M. , "Za restituciju od 102 do 221 milijarde evra", *Politika Online*, 24/09/2009, <http://www.politika.rs/rubrike/tema-dana/Za-restituciju-od-102-do-221-milijarde-evra.sr.html>

Božić, Lj, *Agrarian Policy with the basis of Agrarian Cooperatives*, Sarajevo, 1963.

Ćirković, B. *Expropriation and Fair Compensation in Yugoslavian Law*. Belgrade, 1979;

Foreign Claims Settlement Commission, *2007 Annual Report*, <http://www.usdoj.gov/fcsc/07rpt/annrep07.htm>

Glišić S, "The data analysis of deprived property files", *Hereticus*, Vol. VI (2008), No. I

Kovačević, Nada, Branka, Mališ, "Srbija razgovara: Vraćanje nacionalizovane imovine", *Politika Online*, 20/04/2009, <http://www.politika.rs/rubrike/Drustvo/Srbija-razgovara-Vracanje-nacionalizovane-iovine.lt.html>

Lebl, Aleksandar, "Čija je imovina ubijenih Jevreja", *Politika Online*, 29/07/2009

<http://www.politika.rs/rubrike/ostali-komentari/CHija-je-iovina-ubijenih-Jevreja.lt.html>

\*\*\*"Mreža za restituciju ocenjuje Nacrt zakona o restituciji i građevinskom zemljištu kao do sada najbolje ponuđeno rešenje", 15 May 2007, *Pronadi Pravo*,

<http://www.pronadjipravo.com/index.php?link=opsirnije&id=282&table=vesti>

Malešević, LJ. , "Hotel "Putnik" prodan, naslednici tuže državu", 20. 02. 2009, <http://www.naslovi.net/2009-02-21/dnevnik/hotel-putnik-prodat-naslednici-tuzedrzavu/1048732>

---

Ministry of Finance, internal data.

Mirković M, *Economical History of Yugoslavia*, Zagreb, 1968.

\*\*\* "Nacionalizovana imovina vredna do 220 milijardi evra", 24. 09. 2009, *Biznis*, <http://www.biznisnovine.com/cms/item/stories/sr.html?view=story&id=40149>

Statistical Office of the Republic of Serbia

<http://webrzs.stat.gov.rs/axd/drugastrana.php?Sifra=0001&izbor=odel&tab=30>

Stevanović, Mirjana N. , "Oduzeta imovina sve dalja od bivših vlasnika", *Danas. rs*, 04/08/2009

[http://www.danas.rs/vesti/ekonomija/oduzeta\\_imovina\\_sve\\_dalja\\_od\\_bivskih\\_vlasnika.4.html?news\\_id=168424](http://www.danas.rs/vesti/ekonomija/oduzeta_imovina_sve_dalja_od_bivskih_vlasnika.4.html?news_id=168424)

---

## An Integrative Approach in Treating Complete Food Refusal in Children: a Case Study

**Khamsiah Ismail, Ph. D**

Kulliyyah of Education, International Islamic University Malaysia

Assistant Professor

[ikhamsiah@iium.edu.my](mailto:ikhamsiah@iium.edu.my)

**Siti Rafiah Abd Hamid, Ph. D**

Kulliyyah of Education, International Islamic University Malaysia

Assistant Professor

[srafiah60@iium.edu.my](mailto:srafiah60@iium.edu.my)

### Abstract

*Eating disorders among children may be attributed to the range of complications associated with feeding problems; from mild (e. g. , missed meals) to total food rejection. Many early feeding problems can be diagnosed and corrected either by medical interventions, therapies or behavioural modification. Parents might use reward system in persuading them to eat and in extreme cases, pressure, force and punishment are also applied. There are also cases of children who do not eat at all and simply refuse to eat. For parents of children with feeding disorders, this is the beginning of a long and challenging journey that will include many medical and clinical experts. This paper presents the case study of a 13-year old boy with borderline autism, dyslexia and ADHD who did not consume any food at all i. e. complete food refusal for the first 12 and a half years of his life. In his treatment strategies, the therapist utilized a combination of several interventions strategies based on a few theoretical approaches. This integrative approach designed for his treatment intervention was divided into four phases comprising of: (i) Person-Centred; (ii) Behavioural Therapy; (iii) Cognitive Behavioural Therapy; and (iv) Psycho-educational. His family was also involved in the treatment. This study found that the approaches used in the treatment helps to improve the boy's eating problem as he started to eat pureed and soft food such as porridge. The therapy has also helped him gained self-confidence and improved his communication as well as social skills. He was healthier as he had not been admitted to hospital after the therapy ended. The findings of this study provide evidence that eating disorder problem involving children can be treated with psychotherapy. The treatment plan can be utilized to initiate suitable intervention as an effort to help children as well as adolescents manages their eating problems.*

**Keywords:** Eating disorder, total food rejection, integrative approach, Person-Centred approach, Behavioural Therapy, Cognitive Behavioural Therapy, Psycho-Educational Approach

### Introduction

For many parents, baby's first bite of food is a delightful moment as this is the move leading to a lifetime of memorable family experience of happy mealtimes. Unfortunately, while many parents strive to integrate fruits and vegetables into their child's diet once they start to take solid food, there are children who simply reject the food selections made for them. Parents may plead, persuade or use non-food reward to their children to try new foods. In extreme cases, pressure, force and punishment are also applied. Nonetheless, with some children, none seems to work. For parents of children with feeding delays and disorders, this is the beginning of a long and challenging journey that will include many medical and clinical experts such as gastrointestinal specialists, paediatricians, nutritionists, dieticians and psychologist.

Many early feeding problems can be diagnosed and corrected either by medical interventions, therapies or behavioural modification. Over a period of time, with appropriate interventions and parental efforts, young children who cannot eat properly due to a developmental or physical impairment can gradually improve and begin to consume solid food. But what about children who refuse to eat? This is different for a child who cannot eat for a definable reason or diagnosable problem. In many instances, parents trying everything under the sun to get their children to eat but to no avail. However, there are cases of children who do not eat at all and simply refuse to eat. For the parents of these children, the journey of making their children eat can be painful.

This paper presents the case study of a 13-year old boy who did not accept any food at all i. e. complete food refusal for the first 12 and a half years of his life. An integrative approach was designed for his treatment intervention.

### **Client's Information**

Arief (was given a pseudonym to maintain the ethic of confidentiality) was a 13 year-old boy of Malay ethnic. He was the eldest child of two siblings and his brother was four years younger than him. He attended a class for special educational need student at an integrated primary school. Based on early observation ie. when he was brought to the therapist, Arief was able to do basic arithmetic (simple addition and subtraction) but quite slow in his reading. His language ability and communication was considerably good.

Arief lived with his parents and at weekdays they stayed with his maternal grandparents as his mother helped them to run food catering business and manage a restaurant which was located near their house. The school that he attended was not far from his grandparent's house and hence his family only returned home at weekends. His father worked at the information technology department in a commercial bank. The family had no problem in getting good and healthy food for him but their main concern was that he just refused to eat and totally refused to consume any solid food.

### **Presenting the Problem**

Arief was nine years old when he was referred for treatment in 2009. He seemed not to be interested in food and had never eaten - neither solid nor pureed food at all since his infancy. However, he has no problem swallowing water. Arief would only drink especially milk and most of the time using feeding bottle. As he has normal height for his age although fairly thin, he seemed to get enough nutrients from the milk that he drank. He seemed not to have any emotional problems. Arief had been referred to paediatricians. Other than asthmatic and gastric, medical assessments indicated that there were no physical and health problems that would explain his symptoms. He had been admitted to hospital several times due to his asthmatic and gastric-related problems. His parents also reported that he got tired easily.

They had tried to give him food but to no avail. Arief told them that he did not feel hungry. His parents had been worried about his complete refusal of food as any attempts to help him to eat were met with resistance. They felt that all investigations had been conducted at various hospitals but there was no definite diagnosis made about his problem. They also reported that based on doctors' observation and prior medical reports, the child was said to have borderline autism, dyslexia and attention deficit hyperactivity disorder (ADHD).

Arief's parents claimed that he could not be fed with solid foods since infancy. He was breastfed for three months and then was given formula feeding. He only tolerated milk and nutritious fluids as soya, *ribena*, *vitagen* and *pedisure* milk. He also liked orange juice but it caused him to have gastric pain. He refused to take solid food such as nestum or porridge but he liked to lick soya sauce which was salty. Intermittently, he had abdominal pain that required hospital admission.

Arief did not show oral motor delays. However, his mother observed that Arief had low self-esteem at school. This was probably due to his diet problems as he was still dependent on bottle feeding. Apart from having borderline autism, dyslexia and ADHD, one of the reasons that the parents had to enrol him in a special class was Arief needed help from teachers to make milk for him and special educational need class was quite flexible with their students' routines. Teachers and their assistant were always around and provided helps to the students with special needs and attended to their physical needs.

---

## Client's History Client's History

Arief could not tell the therapist about his eating problem. He simply said "I don't know"; "I don't want to eat"; and "I don't like to eat". Hence, information from the parents enabled the researcher to procure some ideas about the possible causes of his problem. Series of interview were conducted on Arief's parents. Information obtained from them is briefly presented in this section.

Base on his medical reports brought by the parents in the first therapy session, Arief was born preterm at 32 weeks via lower segment caesarean section (LSCS) and his birth weight was 2.42 kilogram. At postnatal, he had distressed syndrome and required assisted ventilation for 10 days in neonatal intensive care unit (NICU). He walked at the age of 13 months. According to the parents, his facial appearance was normal, like other normal children. The first six months of Arief's life were that of a normal baby. Arief's nutrition was his mother's breast and formula milk. He was sent to a baby sitter after his mother's maternity leave ended. At the age of about six or seven months old Arief was hospitalized due to bronchitis and phlegm suction procedure was conducted on him in which, suction tube was put through his throat. His father recalled that the procedure was done for at least three consecutive days. To avoid him from struggling, Arief was wrapped with hospital blanket.

After he was discharged from hospital, Arief's parents said that they had difficulty in feeding him as he started to reject milk and baby food that were given to him but after much persuasion and force, he only consumed milk from feeding bottle and prior to coming for therapy, he drank six to eight bottles of formula milk per day. He was still a bottle dependent and would not drink from other container such as glass and normal bottle. This meant that he had not taken any solid food until the age of 12. The parents reported that there was no family history of similar problem.

Arief's total rejection of food had also affected his relationships with his friends. He could not play football and other games with his friends as he got tired easily and there were several occasions that he had almost fainted. Apart from that, he could easily get asthma attack.

The following sections present a brief literature review related to eating disorders and total food rejection among children. It is followed by presentation of counselling and psychological approaches applied in the therapy which comprises of the treatment strategies and interventions in helping Arief to eat.

## Review of Literature

Eating is a complex reaction consisting of a chain of behaviours that include accepting, chewing, and swallowing the food or drink (Bachmeyer, 2010). When a bite of food enters a child's mouth, the child can allow the bite by the teeth, further inside the mouth on the mid-tongue, with mouth closure, and later allowing the food to be swallowed. However, feeding can be challenging to some children and it is relatively common among typically developing children, with reported prevalence rates of up to 29% (Bachmeyer, 2010). Feeding problems may be attributed to the range of complications associated with feeding problems, from mild (e. g. , missed meals) to total food rejection.

Children with the most significant feeding problems are often described as having food refusal. Food refusal has been defined as a general term that embraces a wide range of a child's feeding problems (Chatoor & Ganiban, 2003; Douglas, 2002, cited in Gardner & Shaw, 2008). Specifically, it refers to a child's refusal to eat all or most foods presented, resulting in the child's failure to meet his or her caloric and nutritional needs (Field, Garland, & Williams, 2003). Decreased appetite can also be applied to food refusal (Stainano, 2003). Unpredictable food refusal, selective food refusal and fear-based food refusal are among the expressions of food refusal (Chatoor & Ganiban, 2003) and resulting in dependence on liquid oral feedings (e. g. , bottle feeding, tube feeding).

Total or complete food refusal however has not been directly mentioned in The Diagnostic and Statistical Manual of Mental Disorders – Text Revision (DSM-IV-TR) (APA, 2000). Nevertheless feeding disorder of infancy or early childhood in DSM-IV-TR has been renamed in version of the DSM-5 as avoidant/restrictive food intake disorder (APA, 2013). The criteria for this disorder also have been significantly expanded to include individuals, primarily but not exclusively children and adolescents, substantially restrict their food intake and experience significant associated physiological or psychosocial problems but do not meet criteria for any DSM-IV eating disorder. Avoidant/restrictive food intake disorder is a broad category intended to capture this range of presentations (Grohol, 2013). "Some authors have conceptualized eating



disorders in pre-pubertal children as early manifestations of anorexia nervosa, but these children rarely met DSM-III-R diagnostic criteria” (Singer, Ambuel, Wade and Jaffe, 1992, pp 847, cited in Vaughan, 2000). Nevertheless, their health risks can be as serious as those risks for children with a clear diagnosis.

Studies have reported that the prevalence of eating problems in general was found to be high among children with developmental disabilities, with rates ranging from as high as 35% (Bachmeyer, 2009). Findings from the studies revealed that, children who have been identified by the refusal of food have also been diagnosed with a developmental disability.

Although food refusal is relatively common, it can pose a significant health risk for some children (Chatoor & Ganiban, 2003). Children who refuse food have similar health risks to people diagnosed with anorexia and food deficiency, for any grounds, can cause physical problems. Severe food refusal, if left untreated, can result in weight loss, malnutrition, fatigue, impaired mental or physical development, and even death (Christophersen & Hall, 1978 as cited in Bachmeyer, 2010). It can also cause more serious effect on the psychological development of children. Their eating disorder can also lead to persistent medical procedures, admission to hospital, and eventually cause limitation in social emotional as well as educational functioning and development (Kerwin, 1999). Thus, early intervention and treatment of eating disorders such as food refusal is extremely important in caring for the health of the children as well as the adolescents.

Limited literature was found about eating disorders in pre-pubertal children, especially those who are otherwise healthy and have no obvious developmental disabilities (Singer et al. , 1992, in Vaughan, 2000). Most of the researchers focus on other types of eating disorders affecting children and teen agers such as bulimia, anorexia nervosa and binge eating. There are also numerous literatures on children eating problem such as neophobia, selective eating, picky eating, restrictive eating and binge eating especially among children. Treatment for total food rejection is even more critical. Many intervention strategies and theoretical approaches were suggested and utilised but little has been written on treatment of total food rejection. Among the treatments presently offered to treat a range of eating disorders include anti-depressant medication, hospitalization, individual psychotherapy, family therapy, classical and operant conditioning, and cognitive restructuring (Vaughan, 2000). In relation to individual psychotherapy, behaviour analysis was recommended as one the effective preliminary approach to identify problematic behaviours during mealtimes and then to “teach” an appropriate set of behaviours that will yield a proper mealtime experience (Zimmerman, 2010). Others suggested Cognitive-behavioural Therapy (CBT) for the treatment of eating disorders (Hay, Bacaltchuk, Stefano & Kashyap, 2009) as they believed that the approach has been effectively utilized in many treatment procedures (Murphy, Straebler, Cooper & Fairburn, 2010).

Identifying and diagnosing eating problems in children can be more challenging than we might think. However, upon obtaining and analyzing the information from the parents as well as literatures on eating disorder-related studies, it is believed that this 13-year old boy’s total food rejection was due to fear and traumatic experience. This assumption is also based on one of Chatoor and Ganiban’s (2003) postulation that an expression of food refusal can also be observed in different qualitative ways including fear-based food refusal. In this case study, the therapist explored the utilization of a combination of several interventions strategies based on a few theoretical approaches i. e. an integrative approach in treating a young client who totally rejected food since infancy.

### **Treatment Intervention Plan**

It is important to note that the intervention was planned to treat Arief eating-related problem. The therapist did not conduct any assessment for his reported borderline autism, dyslexia and ADHD as the problem has been diagnosed by medical doctors earlier. For his complete food rejections problem, intervention plan for Arief’s treatment was divided into four phases as follows:

- i. Person-Centred approach
- ii. Behavioural Therapy
- iii. Cognitive Behavioural Therapy
- iv. Psycho-Educational Approach

## Phase 1

### Person-Centred Approach (PCT)

The client was nine years old when he was first referred to the therapist. Even though his autism, dyslexia and ADHD were at borderline, it was quite challenging to get his attention. Hence, development of therapeutic relationship with this client is very important. Rogers (1957, reproduced in Kirschenbaum & Henderson, 1990) believed that a therapist must demonstrate three core conditions which are empathetic, communicate an unconditional positive regard for the client, and shows genuineness or congruence in order to foster a strong therapeutic relationship and create a psychological atmosphere. These conditions will help the client feel safe to examine their situations and not being judged and eventually they can be empowered to take the steps necessary to grow and self-actualize (Rodriguez, n. d. ). Apart from that, children and psychotherapists need to create an entire therapeutic world in which children actively engage in appropriate expression of emotion and are able to focus on their strengths (Landreth & Bratton (2000).

### Intervention Strategies

i. Development of rapport started with play therapy. It was conducted using some small toys including army and army vehicles (his own choice as he said he liked them) as well as other animal miniatures. The therapist sat on the floor with him and started talking to him but he did not respond much in the conversation. Most of the time he shook or nodded his head (indication 'yes' or 'no'), raised his shoulder or simply said "I don't know". As the therapist proceed with the play Arief felt more comfortable. He started to interact with her to share about what he liked and disliked, his family, school, and friends. There was a minimal eye contact though. Nevertheless, he did not feel safe as he also kept going to the window or door checking if the mother was still around.

ii. The next course of action was taking Arief to cafeteria and shop which were located within the therapist's office premise. This 'tour' was aimed to observe if he recognized different types of food, their names and whether he could stand the smell of the food. He could name the foods but could not take their smells. When asked to guess the taste of the food, his response was "delicious but I don't want to eat" (*sedap tapi Arief tak nak makan*). In the shop, he was asked to pick any food that he wanted but only took some food for his younger brother and none for him with the same remarks "I don't want to eat" (*Arief tak nak makan*).

iii. Development of rapport and trust continued with playing toys and reading children story books at the toy corner in the therapy room. His conversation showed some improvement after the third session. We started to focus on his positive aspects such as his look, his hobbies and his improved communication skills as well as confidence in expressing his ideas during play therapy and book reading. It is important to mention here that there was a time that he requested the therapist to accompany him for a medical assessment involving an x-ray procedure at a government hospital. Taking into consideration of his psychological and cognitive conditions (low self-esteem and other borderline disorders) and also to maintain the rapport and trust that has been developed the therapist presented herself at the hospital for that procedure. Nevertheless at this juncture, there was still no mention about food and why he refused to eat. This was in agreement with Rogers (1957, reproduced in Kirschenbaum & Henderson, 1990) who believed that "what clients need is not the judgment, interpretation, advice or direction of experts, but supportive counsellors and therapists to help them rediscover and trust their 'inner experiencing'..., achieve their own insights, and set their own direction" (Kirschenbaum, 2004, p. 121)

The therapist also guided him in writing short notes after each session. This was meant to give him some empowerment and showed that the therapist had trust in him writing his own report. As he did not read and write well, the therapist assisted him with the spellings. The report was brief and short and contained about four to five lines for each session. It was obvious that he got mixed up with the alphabets like 'b' with 'd', and 'p' with 'q' in his spellings. This is an indication of dyslexia - not being able to tell the difference between letters that have similar shape but different orientation.

### Behavioural Therapy

After initial treatment sessions to establish a relationship with Arief, behavioural therapy techniques followed. In behavioural therapy, the goal is to reinforce desirable behaviours and eliminate unwanted or maladaptive ones. The techniques used

in this type of treatment are based on the Behavioural theories ie. classical and operant conditionings (Cherry, 2012). The goal is to teach Arief new behaviours in that it minimize or eliminate the issue he was having.

### **Intervention Strategies**

Arief had a propensity to lose his focus easily. He also could not sit still and at times just refused to participate in therapy activity. So operant conditioning was adopted in which behaviour modification was exercised by utilizing reinforcement to encourage or discourage certain behaviour. In this regard, rewards were set up. Arief was rewarded for engaging in positive behaviour. The reward was variety of stickers that boys might like such as pictures of transport, dinosaurs, children heroes (e. g. superman) etc.

i. We agreed that Arief would be rewarded for his good work and behaviour during the session which comprised of:

- giving eye contact when talking – one sticker of the therapist choice;
- less body movements while communicating (restlessness) – one sticker of the therapist choice;
- participating in conversation and activities – one sticker of the therapist choice; and
- writing notes in his diary - one sticker of his choice.

ii. Arief was assigned to write notes of his sessions with the therapist. He was also given a task to write his diary of activities in a notebook at home in between the sessions.

Sometimes he could get up to four stickers pasted on his note book. He gave the impression that he was happy and expressed that he liked to come to therapy sessions and looking forward to come again. Behaviour wise, Arief demonstrated some progress. His responses to questions got better. Apart from that, he was not only writing his activities at home with help of his mother, but he also read the report to the therapist. The report was brief but he has made some efforts. Further reward system will be presented in later sessions.

### **Phase 2: Cognitive Behavioural Therapy (CBT)**

Once trust was developed and the client felt more comfortable in his interaction with the therapist and he demonstrated behaviour improvement, the therapy was focused on his irrational beliefs and maladaptive thoughts. The therapist asked him if he wanted to eat and he said, "Yes but I'm afraid that I'll get choked" (*Ya tapi takut tercekik*). When asked what make him refused to eat, he gave similar reason, "I want to eat, but I am afraid that I might get choked" (*Arief nak makan tapi kalau makan nanti tercekik*). So, it was very obvious that he has irrational belief that he would get choked if he consumed food.

### **Intervention Strategies**

For the second phase of treatment, CBT approach was employed. CBT is a psychotherapeutic approach that addresses dysfunctional emotions, maladaptive behaviours and cognitive processes and contents through a number of goal-oriented, explicit systematic procedures. So, the name refers to behaviour therapy, cognitive therapy, and therapy based upon a combination of basic behavioural and cognitive principles and research (Schacter, Gilbert, & Wegner, 2010). CBT refers to a group of approaches (i. e. rational emotive therapy, cognitive therapy) that presume a client's cognitions shape the way they feel and act (Guterman & Rudes, 2005). "CBT works by changing people's attitudes and their behaviour by focusing on the thoughts, images, beliefs and attitudes that we hold (our cognitive processes) and how this relates to the way we behave, as a way of dealing with emotional problems" (Martin, 2003, p. 1). Hence, in utilizing CBT approach the

researcher focused on how irrational beliefs or maladaptive thoughts contributed to the client's maladaptive emotions and behaviours.

The therapy aims to break overwhelming problems down into smaller parts to make them easier to cope with. During the treatment the therapist and client focus on the here and now. In other words, therapy focus on the then current issues and dilemmas while noting how past events has shaped his thinking and eventually his behaviours. The therapy was divided into two parts which were cognitive and behavioural phases respectively. In a simpler description, CBT is an action-directive, solution-focused approach to therapy. By utilizing the therapeutic approach, the researcher helped the clients eradicate irrational beliefs and move towards their goals in more effective and efficient manner as outlined by Guterman and Rudes (2005, pp. 230-239): (a) problem definition and goal setting; (b) accessing and examining thoughts, identifying irrational beliefs; (c) disputing irrational beliefs and other cognitive-behavioural techniques; (d) assigning homework and tasks; and (e) re-evaluating the problem and goal. In cognitive phase, the therapist focused on steps (a), (b) and part of (c) while in the behavioural phase, the therapist continued with another aspect of part (c) and proceed with (d) and (e).

#### i. Cognitive Phase

Cognitive processes refer to client's thoughts, including his ideas, beliefs and attitudes. The cognitive element of CBT looks at the way one's thoughts can trigger or stimulate certain feelings and behaviours. Its goal is to change patterns of thinking or behaviour that are behind people's difficulties, and so change the way they feel (Martin, 2013).

##### (a) *Problem Definition and Goal Setting*

Arief could not relate much about what brought him to the therapist except "My mother and father brought me here so that you can make me eat". However when asked whether he wanted to eat, he said, "Yes, I want to eat, but I am afraid if I get choked". This is the **automatic thoughts** that he had. Thus at this juncture, the goal of the therapy was also to help Arief understood negative thought patterns he might have, how they affected him and, more importantly, what he could do to change them. Once accomplished, he would subsequently be able to eat.

##### (b) *Accessing and Examining Thoughts, Identifying Irrational Beliefs*

From the therapist observation, Arief was scared to eat as he had developed the thought that the food would clog in his throat, remained there and subsequently he will be choked. With reference to information obtained from his parents, his fearful and traumatic experience probably developed in his infancy i. e. when tube was inserted into his throat to such out phlegm was not attended to. Persuasion, pressure and force to eat did not seem to work. Although the incident took place when he was still very young to remember, most likely less attention was given on the psychological aspects which contribute to the underlying issues related to the problem especially his anxiety and fear. As suggested by Beck, these thinking patterns are building up in childhood, and become automatic and relatively fixed (Martin, 2013). So, he grew up believing that he could not eat and could never be able to eat. He was afraid to make any attempt to put food into his mouth. Attempts to feed him were unsuccessful as he got angry, threw tantrums and in due course totally rejected food. He only tolerated liquid as to him, "I drink water only because I won't get choked" (*Arief minum air aja sebab tak tercekik*).

##### (c) *Disputing Irrational Beliefs and Other Cognitive-Behavioural Techniques*

As treatment progressed, disputing irrational beliefs were initiated and cognitive restructuring techniques which aimed at recognizing and changing problem thinking patterns were introduced. An array of techniques was applied in CBT "to help individuals dispute irrational beliefs, and, in turn, eradicate emotional and behavioural problems so that they can work towards their goals in an effective and efficient manner" (Guterman & Rudes, 2005, p. 226).

Automatic thoughts and beliefs that perpetuate the problems (“I will get choked if I eat”) are identified and work aimed at developing new perspectives and ideas began. The therapist only focused on two questions related to eating behaviour of people around him: “Have you observed people eating?” and “What happen to them when they eat?” Examples of his responses were as follows:

*“My younger brother can eat and he doesn’t have any problem”*

*“My classmates also eat and they are O. K. ”*

*“My friends who play football with me are strong and they play longer. They have energy and fit. . . because they eat”*

*“My classmates don’t bring feeding bottles to school. . . . teacher give food and they eat”*

Next the therapist helped Arief to read a book entitled “Our Body” (*Badan Kita*). This was children book which displayed pictures of human body and explains the functions of parts of the body. There was a chapter on why people need food and what happen to them if they eat. Pictures of foods and food pyramid were also provided. There were also explanations on why people need food and the nutrition benefits of the food in the pyramid. He was later asked to explain the consequences if people do not eat. This required Arief to take the role of the person in the book where he has to post the questions to himself and then answer the questions:

“Why I need food?”

- Response: I need food because. . . . .”

“What will happen to me if I eat?”

- Response: “ If I eat. . . . . ”

“What will happen to me if I do not eat?”

- Response: “If I don’t eat . . . . . ”

\*Answers were all based on the book that he had just read.

Later the therapist focused on the pictures of digestive system and showed to him that there is no obstruction in the throat that could block the movement of food when we swallow that could lead to choking. Arief was later shown a video on you tube entitled “Human Digestive System” (<https://www.youtube.com/watch?v=b20VRR9C37Q>). This video began with the process of eating, i. e. putting food into mouth, biting, chewing and swallowing before the food enters the digestive system. After further explanation by the therapist Arief agreed that there is no obstruction in the throat that could block the movement of food that he would swallow that could lead to choking. This discussion was meant to dispute his irrational belief and restructure his automatic thought about “I will get choked if I eat. ”

His medical reports and the therapist opportunity to observe the X-ray procedure when the water that he swallowed flowed down straight into his stomach increase the confidence. At this juncture, the therapist believed that Arief was able to eat. The next question was posted, “Can we get something so that you can try to eat?” With a low voice he said “May be. . . . . but are you sure that I won’t get choked?”

## ii. Behavioural Phase

This is a continuation of the aforementioned step which was disputing irrational beliefs and other cognitive-behavioural techniques. Behavioural therapy notes that behaviour is often learned and can therefore be unlearned. It looks at unsafe or maladaptive behaviours and helps client to understand why the behaviour occur and what he can do to change them (Martin, 2013). Arief agreed that he could try to eat. These sessions started in the beginning of the third year of therapy.

---

The therapist requested for Arief to come every week (Thursday) just to keep him in the right momentum as longer break period might affect his efficacy and motivation.

The following are the observations on the experience of Arief's break-through to eating which was done through a lot of persuasions:

*First week*

Arief was accompanied by his father. The therapist obtained consensus from him to begin feeding Arief with food. To begin with, the therapist used spoon to feed him strawberry flavoured blended ice. He showed grimaces like he was eating a bitter or sour food but swallowed the blended ice with much difficulty. The fear of swallowing was very obvious. He agreed on three spoons.

*Second week*

The therapist fed him with very soft vanilla flavoured puddings. His grimaces were quite bad this time and he was on the verge of throwing up – but did not vomit. He drank a lot of water after every feedings indicating that the fear of choking still existed. Arief looked very stressful and rejected the fifth spoon. So he was not force to take more puddings. The therapist noticed that he just swallowed and did not chew the food.

Reward system was again set-up here. He always asked the therapist if he could play computer games on her computer. The agreement was, he would be given five minutes of computer games for every spoon that he ate and it would begin in the coming session.

*Third week*

Deep breathing exercise was introduced to reduce his anxiety and stress. The therapist helped him to do jaw exercise involving jaw movements (open mouth widely and close, twisting to left and right and chewing exercise – without food). He was also taught to move his tongue from side to side to help him control food in the mouth when he began to consume solid food.

For eating session, there was not much of a difference - he took four spoons of chocolate flavoured very soft puddings. He still had a glass of plain water in his hand and quickly drank after every feeding. So as a reward he wall allowed to play computer game for 20 minutes after the session.

He was encouraged not to show grimaces and his facial reaction after each feeding improved. Arief's mother who accompanied him this time was asked to bring very soft rice porridge for the coming session. More importantly, Arief agreed to try.

*Fourth week*

This session began with breathing exercise followed by chewing and tongue movement exercises. Arief had never chewed anything before and hence he did not have the skill. Chewing and controlling food in his mouth could be quite challenging for him. This was very important as the therapist needed to prepare him for solid food. The concern was, he might get chocked if he simply swallowed the food and to redevelop his confidence could be more challenging.

The porridge looked almost like puree. It was rather tough to convince him that he would be alright if he eats. He was ready with two bottles of plain water this time. Arief tried to delay the feeding by asking the therapist a lot of questions – about the weather (it was raining heavily outside at that time) and about her students that he knew. He also made a lot of excuses by going to toilet, checking on who was walking outside the therapist office and sometimes pretended to look for his mother. He even hid under a table when the therapist answered a friend call at her office door.

The therapist reminded him of what have been agreed in the previous session that he would eat and would be rewarded according to the number of spoons he took. After much persuasion and much difficulty, the therapist managed to feed him five spoons of porridge. He was on the brink of throwing up but managed to control.

Arief was encouraged to continue eating at home. When asked to suggest a person whom he preferred to feed him, he named the family maid, Bibik Ema. The therapist made a call to his maid and informed her about Arief's suggestion and made him talk about the request by himself. He was also asked to write about this in his session report. This is a kind of collaboration contract between the three of us – the therapist, the client and the care provider. He was rewarded with 25 minutes of computer games after the session.

#### *Fifth and Sixth Weeks*

Sessions in fifth and sixth weeks respectively still focused on his eating. The quantity of porridge had increased and at times the therapist managed to feed him up to 10 spoons. He still refused to chew and continued drinking water immediately after every spoon but with less quantity. Another significant observation was Arief could not identify taste differences. Drinks and food were always 'delicious' (*sedap*) to him. There was a time when I asked him about the taste of plain porridge, his response was 'salty' (*masin*). His mother conveyed to the therapist that when his grandfather who came home from a vacation asked him to taste salt from the Dead Sea, he replied that the taste was 'delicious' (*sedap*).

The therapist also helped him to hold his own spoon and put food into his mouth. This action was to develop independency and give him some empowerment and sense of responsibility. To reinforce his behaviour, the reward was not only on computer game but also ice-cream treats and buying book at the shops in the university compound. This reinforcement will be presented later in the psycho-educational approach.

#### (d) Assigning Homework and Tasks

Giving homework and tasks assignments between sessions are vital parts of the therapy process. What this might involve varied. In working with Arief, as mentioned earlier, at the start of the therapy, the therapist asked him to keep a diary of what he did between the sessions. He was not asked to write about his anxiety or incidents that provoke feelings of anxiety or fear toward certain things as he was not able to communicate much and express his feelings and emotion in the initial sessions. He usually wrote about things that he enjoyed doing such as an outing with his family. But when he came back, for the next session we discussed about his feeling and his answer was always "enjoyable" (*seronok*).

As the therapy progressed to another phase, the assignment given consisted of exercises to cope with problem situations of a particular kind. Arief was asked to write on what he had done and experience in the therapy session. At this stage, he was encouraged to write his feelings, emotion and wishes in the report. He also mentioned about his aspirations in education and career. As we proceeded into the third year, Arief was able to spell many words correctly, read his own report of activities at home faster and wrote better. Capital letters and small letters were still mixed-up. He also reported about the amount of food he consumed at home.

Several assignments were given to Arief. The first was to continue with jaw and chewing exercise. His mother was asked to help him with the chewing skill with an aid of a baby teether. The second was to encourage him to have hobbies which outcome could be used to make inferences to his problems related to eating. The first assignment was to rear fish, which the parents agreed to buy a small aquarium and a few pairs of gold fish. He was given the responsibility to feed the fish every morning before going to and coming home from school. Like fish which need to be fed to live, we also discussed why he also needed to eat his breakfast before he left home and eat again for lunch when he reached home. This developed a consciousness in him on why he need food and must eat every day.

Secondly, the therapist suggested to his mother to prepare several flower pots and encourage him to plant tree that could produce flowers or fruits in a short duration. He should also be given the responsibility to take care of the tree, including watering and fertilizing it. These assignments were aimed to help him develop awareness that fish and trees need food to live and survive. Subsequently, he was also made to understand why human being must consume enough food and good nutrition is important for their bodies. In the same way, Arief also need to eat good food to make him strong and healthy.

At this point, the CBT approach seemed to work quite well to dispute and restructure his negative thoughts about food and eating and the cognitive-behavioural techniques planned for him managed to accomplish an important desired goal of the psychotherapy which was helping him to eat.

#### (e) Re-evaluating the Problem and Goal

In CBT approach, therapy goals and strategies have to be continually monitored and evaluated. Thus it is important to note that the goal of therapy is to dispute his irrational beliefs, restructure his distorted thoughts and eventually teach him new skills to more effectively manage his difficulties. Apart from that, he should be able to try to practice these skills outside the session and in his day-to-day life.

As Arief studied in a special educational need class, his mother reported that the lessons taught were more on the basic skills in reading, writing and arithmetic some drawing as well as handicraft activities. Thus, as extensively explained above, the homework and tasks given were practical, and involved trying out new behaviours, thinking strategies, etc. , rather than the kind of homework associated with his classroom learning.

There are no tests in CBT. Thus, tasks and activities that happened outside of sessions aimed to attribute improvement in his problems to his own efforts, in collaboration with the therapist and his family, especially his parents. Weekly reports from his parents were also utilized for the reevaluation of the problem and therapy goals.

It is important to note that Arief showed better participation in the therapy. By the third year, he was able to follow instruction, participated in therapy activities, and showed better eye contact when communicating with the therapist. His communication has also improved and could express his feelings and thoughts.

### iii. Psychoeducational Approach

"Psychoeducation is a professionally delivered treatment modality that integrates and synergizes psychotherapeutic and educational interventions" (Lukens & McFarlane, 2004, p. 206). They indicated that in many instances, the client and/or family are considered partners with the treatment provider on the basis that the more knowledgeable the care recipients and informal caregivers are, the more positive health-related outcomes will be for all. Hence, psycho education can be observed as a more holistic and competence-based approach, emphasizing health, collaboration, coping, and empowerment (Dixon, 1999; Marsh, 1992 in Lukens & McFarlane, 2004).

In working with Arief, the therapist believed that rather than focussing on working with him alone, the best possible results could be also realized when the psychoeducational intervention was initiated. The intervention was based on a collaborative partnership between the therapist, family and client. In this regard, as the therapy session progress, apart from direct therapist-client kind of relationship or rather expert-driven approach, we should also have indirect working relationship where family work together to come up with strategies for feeding the child takes charge of the child's development at home.

### **Family Involvement**

Family members often experience heightened level of worry when they have someone among them who refused to eat. Parents often feel vulnerable in their efforts to treat a child who totally reject food. However, family involvement is critical as they are an integral part of the treatment team. The chances that our children recover from an eating disorder will be increased with family involvement in supporting and maintaining coping strategies (Ekern, 2012).

In Arief's case, his parents' strong support and help provided positive impact in the treatment. He was accompanied by either parents, or sometimes both of them came together. They left Arief alone with me and joined us at the end of the session to discuss about their son's progress and also to receive further assignments from the therapist to work with Arief



at home. We planned on our roles and responsibilities – the therapist conducting the therapy and the parents providing support at home.

Family participation has also been demonstrated as effective method of treatment for many children with eating disorder (Robin, Gilroy & Dennis in Vaughan, 2000). As Arief preferred to be fed by his family maid, the parents needed to make sure he ate the three main meals – breakfast, lunch and dinner and also reduce the quantity of water between each spoon.

The therapy also requires family working together to come up with strategies for feeding the child. Other than fish rearing and little agricultural activities, Arief's parents and the therapist also plan for other intervention strategies outside the session including improving his academic achievement and at the same time enhancing his self-esteem as well as psychosocial skills. Besides that, his other interest and strength were also explored. His parents sent him to tuition class and music lesson. A retired music director who came to know about our treatment strategies and his interest in music offered to give him free piano lessons.

Since Arief was in a special need class, he was given the privilege of staying longer in primary school. His parents made a request to the school to allow him to take the national assessment test for primary school which was compulsory for normal students. His examination result would determine if he qualified to study in regular classrooms under the Malaysia Ministry Education's inclusive education.

### **Limitation of the Study**

Arief's treatment took almost three years. It is a rather long series of therapy. Sometimes the therapist could not see him for almost two months due to several reasons. Sometimes the parents could not take him for therapy sessions as his mother was busy with her food catering business and his mother was busy with his work commitment. The therapist also change her workplaces twice in the three years. Apart from that, Arief's case was the first child eating disorder problem handled by the therapist. A lot of research work and references had to be made to really understand the nature of the problem and to work on the right and feasible treatment plan, especially involving a child with borderline autism, dyslexia and ADHD.

### **Recommendations for Further Study**

"Feeding problems, including those exhibited by children who have established patterns of eating, are not homogenous. Thus, treatment strategies should be selected individually based on existing eating patterns and potential maintaining variables" (Bachmeyer, 2009, p. 50). It is interesting to note that the treatment process of a child with complete food rejection problem is even more difficult but therapists and other professionals must trust that it is possible. The affected children might come from diverse family background along with different kinds of health problems. Eating problems themselves are complicated. Thus, additional research for prevention measures and treatment intervention must be carried out as a treatment strategy designed for one child probably might not work on other child or in other words it cannot be replicated for another child. Apart from that, parents' or other adults' in the family attention is also need to maintain appropriate mealtime behaviour.

### **Summary and Conclusion**

The therapist believed that the treatment was successful. The goal of therapy which was to help him to eat was achieved. The intervention was carefully planned and carried out as this was the first experience of this therapist handling this type of eating disorder specifically total food rejection. What made it more challenging was that he has borderline dyslexia and autism and ADHD. To gain his focus, attention, and participation was sometimes tough and required a rather high level of patience and passion.

Nevertheless, there were several factors that contribute to success of the therapy. Firstly, it was Arief trust on the therapist and also the unconditional positive acceptance on the therapist side. Once strong trust had been developed, his resistance towards the therapy activities was minimized. He was always looking forward to come to the therapy sessions. The pre and post intervention strategies for each session required careful preparation and lots of readings as this was the first time that the therapist was encountered with the problem in her years of practice. Furthermore, there is so little written on the topic of childhood food phobias and what more complete food rejection. Most literature groups it together with difficulty swallowing. However, application of CBT approach in the therapy appeared fruitful. In understanding the development of Arief's problem and the progress of his treatment, we might need to agree with Albert Ellis postulation in his ABC model that "...people experience undesirable activating events (A) about which they have rational and irrational beliefs (B) which lead to emotional, behavioural, and cognitive consequences (C). Rational beliefs lead to functional consequences, while irrational beliefs lead to dysfunctional consequences" (David, Szentagotai, Eva, & Macavei (2005), p. 176). This opinion was really helpful in designing the intervention strategies.

Arief had to wait too long before he could consume solid food. Paediatricians and nutritionist believed that babies who are not introduced to solid foods until later in the first year may have a difficult time learning to eat different textures and flavours of foods. This was what exactly happened to Arief. Nonetheless for Arief's case, his parents believed that it was better late than never. Their tireless effort, support and cooperation facilitated the treatment procedure and process and eventually made a breakthrough to the treatment. The therapist terminated the session when Arief started to eat and had shown psychosocial improvement but Arief and his mother always report his progress through phone calls. He was still lacking in chewing skill. To develop skills and confidence for him to take solid food like rice, vegetable, fruit and other food associated with the Malay culture, and also eradicate the food phobia will require another long journey. Nonetheless, it is a pleasure to receive report from his parent that he had neither have serious health problems nor he had been admitted to hospital after the therapy termination, and more importantly, once he started to eat.

## References

- American Psychiatric Association. (2000). *Diagnostic and statistical manual of mental disorders* (4<sup>th</sup> ed. , text rev. ). Washington, DC: Author
- Bachmeyer, M. H. (2010). *An evaluation of motivating operations in the treatment of food refusal*. PhD (Doctor of Philosophy) thesis, University of Iowa. Retrieved March 3, 2014. <http://ir.uiowa.edu/etd/637>
- Bachmeyer, M. H. (2009). Treatment of Selective and Inadequate Food Intake in Children: A review and practical guide. *Behavior Analysis in Practice*, Spring, 2 (1): 43–50 Retrieved June 22, 2014. <http://www.ncbi.nlm.nih.gov/pmc/articles/PMC2854063/>
- Chatoor, I. , & Ganiban, J. (2003). Food refusal by infants and young children: Diagnosis and treatment. *Cognitive and Behavioral Practice*, 10 (2), 138–146.
- Cherry, K. (2012). Introduction to Operant Conditioning. Retrieved July 25, 2012. <http://psychology.about.com/od/behavioralpsychology/a/introopcond.htm>
- Dahl, M. , Eklund, G. & Sundelin, C. (1986). Early feeding problems in an affluent society. II. Determinants. *Acta Paediatrica Scandinavica*, 75, 380-7.
- David, D. , Szentagotai, A. , Eva, K. , & Macavei, B. (2005). A synopsis of rational emotive behavior therapy (REBT): Fundamental and applied research. *Journal of Rational-Emotive & Cognitive-Behavioral Therapy*, 23, 175-221. Retrieved April 12, 2014. <http://dx.doi.org/10.1007/s10942-005-0011-0>,
- Douglas, J. (2002). Psychological treatment of food refusal in young children. *Child and Adolescent Mental Health*, 7, 173–180.
- Ekern, J. (2012). Teen, Adolescent and Children's Eating Disorders – Eating Disorder Hope. Retrieved February 6, 2014. <http://www.eatingdisorder.hope.com/>

- Field, D. , Garland, M. , & Williams, K. (2003). Correlates of specific childhood feeding problems. *Journal of Pediatrics and Child Health*, 39 (4), 299-304.
- Gardner & Shaw (2008). *Behavioral problems of infancy and preschool children (0–5)*. *Rutter's Child and Adolescent Psychiatry*, 5th edition. Edited by M. Rutter, D. Bishop, D. Pine, S. Scott, J. Stevenson, E. Taylor and A. Thapar. UK: Blackwell Publishing
- Grohol, J. (2013). DSM-5 Changes: Feeding & Eating Disorders. *Psych Central*. Retrieved December 3, 2013. <http://pro.psychcentral.com/2013/dsm-5-changes-feeding-eating-disorders/004412.html>
- Guterman, J. , & Rudes, J. (2005). A solution-focused approach to rational-emotive behavior therapy: Toward a theoretical integration. [Electronic version]. *Journal of Rational & Cognitive-Behavioral Therapy* 23 (3), 223-244. Retrieved January 16, 2007, from ProQuest database
- Hay P. P, Bacaltchuk J, Stefano S, Kashyap P. (2009). Psychological treatments for bulimia nervosa and bingeing. *Cochrane Database of Systematic Reviews*: 2009: 4 CD000562 [PubMed]
- Kerwin, M. L. E. (1999). Empirically supported treatments in pediatric psychology: Severe feeding problems. *Journal of Pediatric Psychology* 24 (3). 193-214.
- Kirschenbaum, H. & Henderson, V. L. (Eds) (1990). *The Carl Rogers Reader*. London: Constable.
- Landreth, G. L. , & Bratton, S. (2000). Play therapy. *Journal of Counseling and Human Development*, 31 (1), 1-12.
- Lukens, E. P. , McFarlane, W. R. (2004). Psychoeducation as Evidence-Based Practice: Considerations for Practice, Research, and Policy in "Brief Treatment and Crisis Intervention" Vol. 4 No. 3, <sup>a</sup> Oxford University Press 2004
- Martin, B. (2007). In-Depth: Cognitive Behavioral Therapy. *Psych Central*. Retrieved November 23, 2014. <http://psychcentral.com/lib/in-depth-cognitive-behavioral-therapy/000907>
- Murphy, R, Straebl, S, Cooper, Z & Fairburn, C. G. (2010). Cognitive Behavioral Therapy for Eating Disorders. *Psychiatr Clin North Am*. Sep 2010; 33 (3): 611–627. doi: 10.1016/j.psc.2010.04.004
- Rodriguez, K., (n. d. ). *Applying an Integrated Approach to a Case Example: Cognitive Behavioral Therapy and Person-Centered Therapy*. Retrieved July 4, 2012. <https://www.academia.edu/443748/>
- Schacter, D. L. , Daniel T. Gilbert, D. T. , Daniel M. Wegner, D. M. (2010). *Psychology*. Macmillan: Worth Publisher
- Staiano, A. (2003). Food Refusal in Toddlers With Chronic Diseases. *Journal of Pediatric Gastroenterology & Nutrition*, 37 (3), 225-227. Retrieved May 2, 2012. [http://journals.lww.com/jpgn/Fulltext/2003/09000/Food\\_Refusal\\_In\\_Toddlers\\_With\\_Chronic\\_Diseases.4.aspx](http://journals.lww.com/jpgn/Fulltext/2003/09000/Food_Refusal_In_Toddlers_With_Chronic_Diseases.4.aspx)
- Vaughan, (2000). Effective Treatments for Anorexia and Food Refusal in Children *J Am Acad Child Adolesc Psychiatry*. 1992 Sep;31 (5): 847-52. Retrieved Mac 21, 2013 [http://www.vanderbilt.edu/AnS/psychology/health\\_psychology/FoodRefusal.htm](http://www.vanderbilt.edu/AnS/psychology/health_psychology/FoodRefusal.htm)
- Zimmerman, B. (2010). Food Refusal. Retrieved April, 23, 2013. [foodrefusal.com](http://www.foodrefusal.com)

---

## Teaching Contemporary and the Role of the Teacher in the Classroom with the Student Centered

**Dr. Prof. Ass. Fatmir Vadahi**

University of Shkodra "Luigi Gurakuqi" Albania,  
Faculty of Education,  
fatmirvadahi@gmail.com

**Mr. sc. Dritan Ceka**

University of Shkodra "Luigi Gurakuqi" Albania,  
Faculty of Education dritanceka@hotmail.com

**Mr. sc. Anila Jaku**

University of Shkodra "Luigi Gurakuqi" Albania,  
anila2010@hotmail.co.uk

### Abstract

*Major changes occurring in the last session in the field of technical and technological tools and recent International Development in the field of education have made a fundamental change in contemporary teaching. Traditionally in Albania education is conducted in the traditional manner teacher was the one who had the main burden while the students were told otherwise spectator or regular headphones. Various changes and reforms in the education field has necessitated changing the way of teaching and have made changes. Today education conditions have changed and taking into account the various investment funds, whether from government or various international organizations have made the traditional method has been implemented to date in Albania be replaced with modern teaching method or the method with different spoken teacher in class with the student center. Today modern teaching techniques have made teaching more attractive for students but also for teachers. Work instructional techniques develop students' creativity, freedom in expression, convenience class. Also classroom setting has a special significance, because it helps to escort students among themselves and work in groups through modern techniques and learning is more productive for students. Modern techniques are very important factor in the work of teachers today they assist their learning except that they also help influence the creativity of the students in the classroom, or otherwise the students to feel the comfort of the people in the class.*

**Keywords:** Teaching, modern techniques, teachers, students

### 1. Introduction

Given that we live in a time that is rich in information and resources to acquire knowledge, it is important to develop skills for knowledge acquisition faster and better. Teaching is a complex relationship between teachers and students, among students themselves, among them students, between students and school administration. Teaching requires a complex skills and attitudes of teachers. Some claim that teaching is based on the knowledge of teachers to plan and develop learning, knowledge about the content to be taught to students. Teaching traditional school far more care about the learning content than the student who learns that content. Furthermore learning process based on verbal learning without being associated with environ- in which the students live and work. Teaching is not just an intellectual and practical activity, but also moral. Effective teaching is a result of positive emotions. A good teacher tries to understand the feelings, desires, inner thoughts pupils, discusses advises and guides. The role of teachers in the classroom with the student center is to facilitate

---

the learning of children based on their needs and interests. In student-centered classroom students get the content, gain skills and develop as individuals and to the whole class is determined by knowing the interests and needs of students in the classroom. Teaching is a form of emotional labor or otherwise can say is emotional practice which involves emotional understanding and is an inseparable part of the work of the pupils in the classroom. From the perspective of working with the students at the center and work based on competences, it is important to motivate students learning resources and stimulate their progress. While textbooks are valuable sources of learning, student's access information learned not only in textbooks. Access and use of a broad spectrum of learning resources, to plan and to realize the learning process in the classroom will avoid learning the routine and provide learning opportunities for learning. Teachers use instructional resource centers to enrich their materials and methods teachers use learning resources that encourage and promote the acquisition of relevant knowledge, developing skills, values and attitudes that lead to the gradual mastery of key competencies. Teaching traditional school far more care about the learning content in school than pupils who learns that content. Furthermore learning process based on verbal learning without being associated with the environment in which the student lives and works. Teaching is associated learning is an activity where the teacher interacts with one or more students.

## **2. The purpose of the research and study objectives**

The purpose and objectives of this research is to investigate whether teachers work more modern teaching techniques that NIAC student centered classroom, a teacher knowledge NIAC modern teaching techniques, he use it in everyday work with students etc.

## **3. Research question, hypothesis and methodology of the paper**

This goal is a description of the current situation in Shkodra schools and Ulcinj. The survey was conducted from grade 1 to 9 in elementary schools. Development has been directly questions the teacher responses were received from teachers who are in the process of working with the students.

The hypothesis of the current teachers or have knowledge of modern teaching techniques that aim NIAC learner-centered?

**4. The importance of research** initiated by the fact that the training of students or teacher training absent additional funding is not made any teaching training who are in the work that a long time and still today use or words work traditional teaching methods.

## **5. Topics of this research are:**

To distinguish the activities of the students in the classroom.

To distinguish methods for the assessment of knowledge of students by teachers.

To distinguish between the methods that teacher uses during the lesson.

To assess the need for change in teaching and learning, taking into consideration the student needs.

## **Contemporary Teaching**

Teaching upgrade the modern based on the knowledge, skills and values that offers an experience that bring students from certain areas they come from. The teacher is the one who should recognize at the same time create a range of teaching strategies to respond to the needs, interests, motivations, attitudes, experiences and requirements of students in the classroom. In the process of teaching is important that the teacher is confident in the abilities and potential students. Students learn easier and better when they are encouraged, when they assessed the level of proficiency of their learning. In this way students will be more motivated to create standard, take responsibility for the manner, style and their

opportunities for learning. It is very important that teaching be based on the principle of linking the work of the school with everyday life. This means to put the students in a real life context, where his knowledge will find fulfillment in real life situations and problematic. Learning should be seen as something that belongs directly to them, as something that belongs to them to build and enrich it. Every modern society is interested to form responsible citizens, capable citizens who will lead the national processes and human values in global society. This will not be achieved without recognition of respect for human rights and freedoms in general, and without recognition and realization of children's rights in particular.

Modern teaching among others encourage and enables the student to be active in the learning process, pays attention to the needs, interests of students, develop initiative and independence for students to learn, develop students' responsibility for achievements to highlight the needs, interests different talents and learning, inclusion of students actively etc. Teaching contemporary inter alia requires the active inclusion of students, individual and group skills, develops skills mutual learning, develops organizational skills and work such as the division of responsibilities, finding the right information, educational placement, teacher interaction students etc. Based on contemporary teaching strategies concluded that essential feature of the success of student learning is precisely the "partnership between teachers and pupils who finds himself realized numerous methods and interactive techniques that constitute its content" where one program that promotes interaction is Developing Critical Thinking Reading and Writing.

### **Planning and organization of learning**

Planning and organization of learning requires more than traditional planning of teaching hours, always based on the achievement of learning outcomes to key competencies, according to the potential and interests that students encounter, then individual differences of the different styles of learning communication and their reports in class, active participation of students in the implementation of new learning new situation, engage students in active mode. It is clear that we cannot talk about perfect mastery of teaching, but based on the content of the work of teachers, in our experience and in the European advanced beyond; a good lesson must necessarily contain some main elements:

To be completely clear objectives are feasible.

Students are given the opportunity to organize their work.

Lessons are to gain students' interest.

Language students be rich and developed etc.

Planning and organization of learning is fundamental to teaching masters involved in the practical work of teachers in the classroom and they are: planning and preparation, development of the teaching, learning management, classroom climate, assessment of student progress, reflection on teaching and appraisal etc. these are some of the basic skills of teaching with student centered. Without learning planning is one of the distinguishing features of teacher mastery as it relates to the daily operation of teachers in the classroom. It's more important to focus on knowledge of the subject teachers and students in early learning, presentation, continue learning, reinforcement learning outcome in classroom management, student motivation, communication with students in their assessment and teaching. There are many opinions today to assess the mastery of teachers. Although there are many opinions and different, they have the following common side. When the teacher teaching methods selected based on previous knowledge and abilities of students. Strategies that he selects students should bring success. This does not mean that we should hesitate to use new methods and techniques. Although personal preferences affect the methodological choices, the teacher continually seeks opportunities to further develop teaching skills.

### **Teaching and assessment process**

Changes in society make the teachers to cope with new tasks in their classes. They face different ways of teaching and other tasks that must be tailored to the students and how they learn, although they are not sure what other changes await in the future. In recent decades, political, social, economic and environmental, as well as the development of science and technology have made every aspect related to school to be reviewed and revised, including the assessment of students. Until recently, the assessment in the classroom is considered as a mechanism for providing a learning index, which has

taken into account a predicted pattern: teachers teach, test the knowledge of students, see their achievements based on those and more than that. Schools in the 21st Century represent the idea of individualized approach which respects the abilities and efforts of each child to create his own way of learning. Teachers who represent this opinion are directed towards the child that is in center the learning process, while the teacher only creates the environment which reflects this perspective. Assessment as an integral part of teaching and learning should serve to prepare the students for the skills needed to achieve the 21st century differs from traditional assessment or words contemporary 21st century.

Traditional assesment	Contemporary assesment
In traditional evaluation is often provided in writing with alternative response assessment means open to evaluation forms	Assesment consists of open ways to teach
Time for assesment	Timing of assessment Assessment is continuous throughout the entire school year
The grade depends only on the basis of a knowledge control rating depends on many things	Assesment depeds of many things
Assesment depends on grades	Rating marked with grade rating is oriented progress
Assessment instruments are subject to change norms for assessment instruments subject to different criteria	Assessment instruments are subject to change norms for assessment instruments subject to different criteria
The evaluation process is separate from the teaching evaluation process related to the learning process	Assesment is related bu learning process
Success depends on the memorization of information presented in the certain	Success depends on the memorization of information presented in the certain moments of success is determined through cooperation and negotiation over a longer period
Knowledge depends on linguistic skills	Understanding measured by linguistic ability (language) and logical / mathematical understanding is measured in the choice of real-life problems
The correct answer is testimony to the efforts and learning of students' views of students used to understand their perception and that those views are included in the next content resides teaching	The views of students used to understand their perception and that those views are included in the next content resides teaching

### **Traditional Assessment Assessments of 21st Century contemporary**

In traditional evaluation is often provided in writing with alternative response assessment means open to evaluation forms

Timing of assessment Assessments is continuous throughout the entire school year

The grade depends only on the basis of a knowledge controlling rating depends on many things

Rating marked with grade rating is oriented progress

Assessment instruments are subject to change norms for assessment instruments subject to different criteria

The evaluation process is separate from the teaching evaluation process related to the learning process

Success depends on the memorization of information presented in the certain moments of success is determined through cooperation and negotiation over a longer period

Understanding measured by linguistic ability (language) and logical / mathematical understanding is measured in the choice of real-life problems

The correct answer is testimony to the efforts and learning of students' views of students used to understand their perception and that those views are included in the next content resides teaching

### Characteristics of a successful modern teaching as perceived by pupils and teachers

According to students, characteristics of a successful teaching are: gravity at work, clarity in teaching, assessment right, to use different methods during the explanation, object recognition, sense of humor, love of students, recognition of students' psychological side, counseling etc. Students teacher describes how effective teachers who have professional preparation, communication skills, creativity, is utilizing the new teaching techniques, originators, modest, and teacher who uses a sense of humor. During the discussion it became clear that one of the main characteristics of a successful teacher was established good relationship with students. According to the students, a teacher is good, when there is good ability to communicate with students, when students understand the situation when advising, respects, is close to them and good behavior.

Teacher's responses	Students responses
Seriousness in the work	Professional Preparation
Knowing the psychological side of expressive	Student's ability
To have a sense of humor	To retrieve different teaching strategies
Be a hard worker	Correctness, Attitude
Keeping different activities	Use of new teaching techniques

Characteristics which were praised by students and teachers for a successful were professional ways of teaching. Cognitive characteristics discussed the most were: professional preparation, variety of teaching methods, the use of attractive, clarity in teaching, expressive skills, knowledge of the case, implementation of the educational program, the fair valuation. An effective teachers, according to them, is a teacher who appreciates straight and equips students more opportunities to demonstrate their learning. According to contemporary teaching successful students are those who explain the clarity of explaining the main features of the unit development, etc. also teaching successful contemporary or evaluate those teachers who use modern teaching techniques. Some of the features of a modern teaching as perceived by teachers and learning are:

### Responses students' responses teacher

Seriousness in the work Professional Preparation

Knowing the psychological side of expressive ability students

To have a sense of humor To retrieve different teaching strategies

Be worker correctness, attitude

Keeping different activities use of new teaching techniques

The role of the teacher is to analyze, plan and implement the learning process through teacher lead at all stages of the theoretical and practical. The role of students is learning to acquire knowledge, develop cognitive skills, to form habits, skills and attitudes.



## Teaching and learning

Teaching and learning are fundamental concepts and actions in achieving educational goals and objectives, and education, in terms and conditions of the institutional organization of the event composite and individual and social value. Teaching and learning the historical development have undergone many changes, which are reflected both in the overall organizational structure, and in particular its structures, which are reflected in the constituent elements of teaching articulation of the various stages of the process of teaching work in whole. Today when we talk about contemporary learning, we can say that this activity has reached the highest level of development in terms of the process of recognition and learning, both in terms of shapes and didactic strategies for organizing actions and functional development of forms and other actions of the teaching work. Learning and teaching process are a didactic communications activities planned and organized, with implementing the objectives and tasks of learning, this activity that takes place under the leadership of teaching and full interactive engagement of students. Learning as pedagogical activity takes place on the organizational structure of external and of internal organization, which expressed stages of working-educational progress and reports to interactive character interactions promote participation in training. As organized process, teaching is an activity which achieved the realization of a certain goal and tasks set. We mainly didactic literature teaching is two models:

1. Direct teaching, with the objective of focusing on rapid achievement of mastery of facts, rules and the formation of habits for them, and content of the course is divided into small steps that easily absorbed; the learning process is supervised by teachers.
2. The teaching of indirect central objective of student involvement in the review and investigation, which helps in the formation and development of concepts in the form of models. Teaching through questions that directs students leads them to discover and generalize, by evaluating their responses. Teaching as interpersonal activities, is the act of teaching directed by the teacher, who plans and organizes the development of the teaching process and learning, to develop processes with students and other collaborators in learning, which has purpose to analyze and evaluation of teaching work to develop. Teaching as a rational process of organizing ergo-didactic activity takes place on the requirements for the transmission and acquisition of human experience, summarized and collated the contents of the plan and the curriculum, the development of vocational skills and positive attitudes of students.

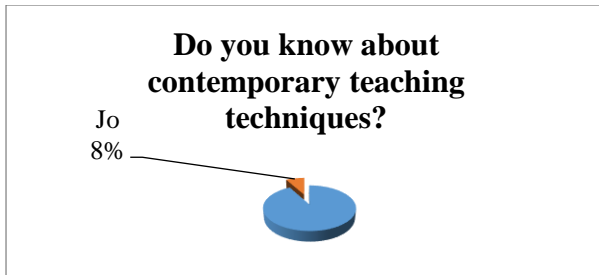
## Techniques that NIAC Methods- Student in the Center

Given that recent developments in the field of education are making new strides in improving the quality of teaching have also changed the method of teaching or words departure from traditional teaching methods to modern teaching method focusing in Ores learning to discussion and debate thus presenting the arguments for a matter of two opposing groups to the listeners, following a standard performance. An important factor which helps a modern teaching are the conditions in which the teaching, learning tools play an important role in the progress of learning such as radio, television, illustration through pictures etc. For now developed a modern teaching methods and student-centered techniques in the teaching process used an entirely techniques and methods. In modern school, apply not one, but a range of teaching methodologies, common of which is the placement of students in the center. By such methodology would mention: Teaching and students through projects, teaching and programmed lessons, learning and discovering, teaching and learning by solving problems and active learning etc. Methods and learning techniques are standard procedures that use teachers in collaboration with students for presenting and developing materials teaching activities to achieve goals and learning objectives. In the literature related to learning methods, in our country and beyond, there is a tendency to give priority to those methods indication that put into action the student, is the interaction between the parties participating in the lesson. Today in the process of contemporary teaching there are a range of techniques that NIAC aim to improve teaching, number of techniques is great but we will only focus to some techniques that are more in use, but will look at research analysis paper how NIAC knowledge and working teachers with modern teaching techniques. Today in use are a range of modern techniques in teaching starting from Brainstorming techniques, Wien diagram, five range, cluster, concepts table, Insert technique, technique save last word for me, learning techniques etc.

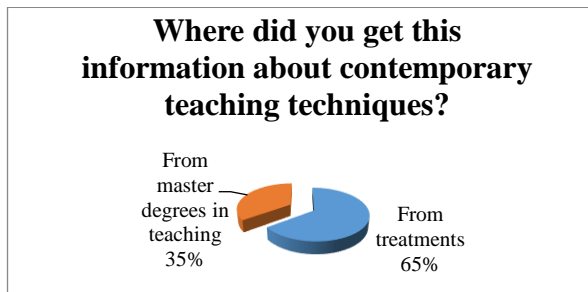
## 6. Analysis, interpretation of data

According to data obtained from the field and discussions we have had with the teacher have these results that will be presented graphically illustrated.

A) In the first question you have showed teachers if you know modern techniques of teaching have these results: 92% of them declared for Yes to NIAC knowledge of contemporary techniques of student-centered teaching and 8% of them declared that not. It is obvious that the majority of teaching NIAC knowledge of modern techniques of teaching the student center.

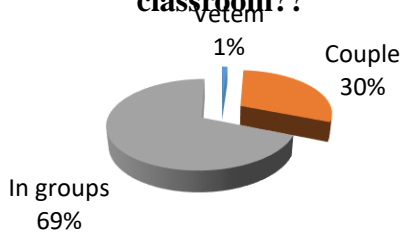


B) The second question turns out you get this knowledge on modern techniques of teaching 65% of teaching declared by teaching while 35% declared by the master in teaching postgraduate studies. Teachers are trained through various programs, the majority part of them are part of the training received by new acquaintances on improving teaching techniques, and the development of modern teaching.



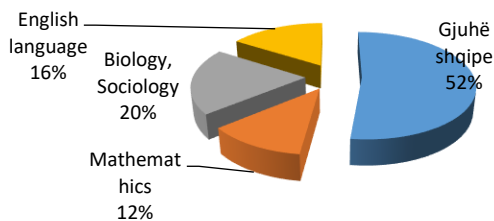
C) When asked how you set the students in the class considering lowering the student forms have the following results: In the group are reduced 69% of the students, the couple is seated 30% and 1% are sitting on. The majority of students are clearly sitting in groups then 30% are sitting couple but mostly are sitting male female and 1% are those children who wish to be alone and have no desire to join their friends in class mainly consist of Roma and Egyptian community.

### How did you place students in the classroom??



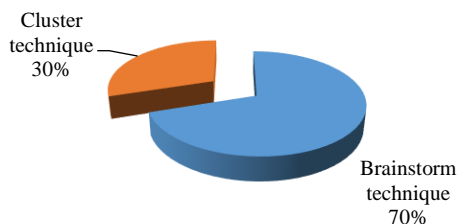
D) The question in cases in which the retrieve mostly retrieve contemporary teaching techniques have the following results: 52% declared that the techniques used in the case of the Albanian language, 20% of them stated that they use in letting Nature and Society, 16% of teachers stated that they use in the teaching of English language and 12% in mathematics. From the results obtained shows that the use of techniques learner-centered teaching mostly realized in the case of the Albanian language.

### In which subjects did you mostly use these techniques?

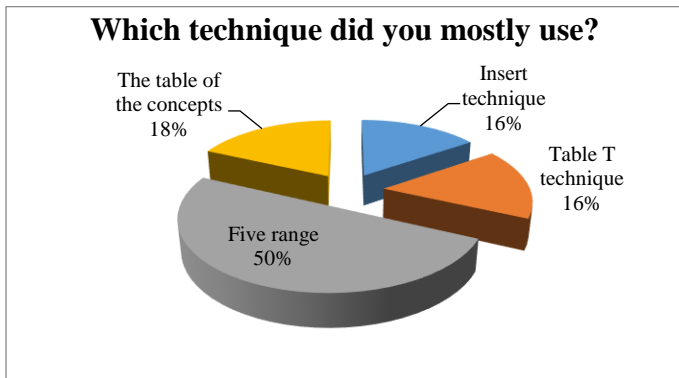


E) In the question which techniques usually start the class 70% of the teachers stated that the use Techniques Brainstorm. While 30% of them declared that the use Techniques cluster seen that the majority of teachers use in the early part ores in Introductory or stated differently in advocacy techniques Brainstorming.

### Which technique did you use in the beginning of the lesson?



F) The question of which techniques they mostly use a lecturer in the central part and the final part or the end of the class have these data: 50% declared to five range, 18% for Table Concepts, 16% for Insert technique and also 16 % Techniques Table T, shows that there is greater use five range techniques.



### Conclusions and Recommendations

Teaching and learning are two basic processes underlying together. The two together are important processes and difficult. Modern Teaching is a complex relationship between students and Teachers. For years has dominated the traditional teaching with the teacher teaching center, and now the roles have changed today in the modern teaching is student centered learning, necessity has led to changing needs and improve teaching. Using modern teaching techniques in modern teaching contributes to an efficient and successful teaching. The usage of teaching techniques enables students to develop critical thinking, as modern teaching learning develops through demonstration etc. Gradually the teacher's role has changed from an authoritarian personality in a cooperative personality, etc. helpful advisory.

- The Ministry of Education should improve environmental conditions for learning.
- To access training for all teachers who are in working process.
- School leaders should involve teachers in training.
- Train teachers to share experiences with their students.

### Bibliography

- Ismaili, Dr. Khadija, Teaching Tools and Critical Thinking, Pristina, 2013.
- Moses, Dr. Bardhyl, Teaching Methodology, Pegi, 2003.
- Manual, Planning and Evaluation of Education, KEC, Prishtina, 2001.
- Nuredini, Dr. Vaxhid, Theory of Learning, learner-centered, Pristina, 2012.
- Authors group, Teacher and Teaching, Vllamasi, Tirana, 2013.
- Fullan, Michael, The New Meaning of Educational Change, CDE, Tirana, 2010.
- Pupovci Tour, Child Rights and Ethics of Teaching, KEC
- Xhejlane Ali, How to be a Successful Teacher, spark, Pristina, 2012.
- Zylfiu, Dr. Niyazi, Learning Theory and Didactic Processes, Pristina, 2011
- Zhitija. Mr. Majlinda, Role of Teachers in Classrooms Learner CENTER

---

## The Distribution in International Marketing - Correlation between International and Local Channels in Kosovo

Hidajet Karaxha PhD candidat

hidajeti\_21@hotmail.com

Halit Karaxha PhD candidat

[halitkaraxhaekonomik@hotmail.com](mailto:halitkaraxhaekonomik@hotmail.com)

Prof. Dr. Ilija KRISTO

ilia.kristo@yahoo.com

### Abstract

*Nowadays, with all these turbulent markets, the international channels are becoming more and more important. The motivation of channel members is an important characteristic in building the relations between international and local channels. The distribution channels in countries in transition can be spread and not effective. Therefore an adequate design of the firm's strategies about marketing should be responsible for the changes between distribution channels in different countries. Sometimes this can require the delegation of marketing functions beyond national affiliates in businesses activities in promoting prices and making the products available for consumers in different countries. The globalization of markets is a phenomenon that has received great attention and is being broadly debated in all levels. In every process of globalization, the distribution of products and services between and inside local industrial markets is very important. The globalization of markets and the reorganization of distribution are interdependent processes that include changes in markets structures. In enhanced national markets, kosovar companies in order to satisfy customer requirements try to specialize the distribution levels of products and services treated with increased pressure to develop a communication in countries of the region and Europe, in dissemination of information that ease the free flow of information and products in national and international borders. This paper contains empirical data that were collected through questionnaires and interviews, and secondary data as well based on reviewing the existing literature about international distribution – the correlation between national and local channels. The final compilation of the questionnaire, the methodology and the sample were realized by analyzing the determining factors that affect the distribution in international markets. The research was realized with the owners, directors, managers and other company holders in Kosovo. The methods that were used in this paper were quantitative and qualitative methods. The sample is intentional (not probable).*

**Keywords:** international marketing, international distribution channels, the design of international channels, the motivation of the international and local channel members.

### International marketing

The international marketing includes business activities designed to plan, to stir up fares, to direct the goods and services of the company for the consumers in different states. (Cateora PH & Gilly M. & Graham J 2011, p. 10). Many companies face the severe competition which is more global and potential in learning international activities, finding their individual clients and widening their aspirations as a result of a global approach in the international marketing (Mühlbacher H. & Leihns H. & Dahringerp L. , 2006, P. 41). According to an approved proposal by AMA (American Marketing Association) the international marketing is a multinational planning process and the execution of concepts, fares, promotion and dissemination of ideas, goods and services to create exchanges in the individual and organizational level (Onkvisit S. & Shaë J. 2004, p. 3).

### International channels of distribution

The international marketing includes the performing of business activities designed to plan, to stir up fares, to direct the goods and services of the company for the consumers in different states. (Cateora PH & Gilly M. & Graham J 2011, p. 10). The international specialists of marketing are conducted by a wide range of channel alternatives. The cooperation of effective channel systems between and inside different markets, presents a difficult challenge conducted by a lot of mediators. At the other extreme, the distribution channels at countries in development can be spread, not effective or doesn't exist at all (Kotler Ph. , Armstrong G. , 2011, p. 354). A challenge of managing an international business is the direct investments in operations in other countries. Many companies first start in the field of international marketing, gain experience and gradually changing their tactics of international marketing in the field of research with the developed plans. Despite the means that are used to enter a foreign market, a company can make a small investment or none at all, which means that its involvement in the marketing can be limited to sell a product (Cateora PH & Gilly M. & Graham J 2011, p. 19). The companies are fully engaged to get involved in the international activities of marketing. These companies are after markets in the whole world to sell their products that are a planned result. This planning doesn't include only the marketing, but also the production of goods outside the international markets (Cateora PH & Gilly M. & Graham J 2011, p. 21). The analysis of distribution channels in contemporary conditions consists in correlation between economic operators from all the levels of production and distribution to the customer's door. This means that the relations should be built not only with customers but with the main suppliers and mediators as well (Segetlija Z. & Mesarić J. & Dujak D. ,2011,p. 793). The international channels of marketing are becoming more and more important. The satisfaction of channel members is a main characteristic in the relations between international and local channels (Schmitz C. & Wagner T. , 2007, p. 5). The distribution channels refer to internal channels (like sales through internet and telephone) and external channels like retailers, partners, distributors, resellers, commercial alliances, suppliers etc. (Munusamy J. & Chelliah Sh. , 2011, p. 2). All countries have laws that regulate marketing's activities in promoting, developing products, labeling, prices and distribution channels (Cateora PH & Gilly M. & Graham J 2011, p. 204). The marketing strategies of the company have to be responsible for the changes in the distribution channels between countries. This may require the delegation of marketing functions beyond the national affiliates (<http://www.att.com>, p. 389).

### The design of international channels

In order to support the growth of international market and the integration of economic activities in the world, it is crucial to have an effective distribution with effective cost. The challenge with the global management of distribution is to structure a responsible supply chain, enough flexible to confront the changes in customers demand and to enable the benefits of the production, focused on the objectives that must be achieved (Osman L. & Westgerd M. , 2008, p. 1). The design of the distribution channel includes the description of the existing distribution channel, by evaluating the environmental impact and other factors that affect the company by defining the needs of consumers and channel's objectives and the evaluation of alternatives to choose the mediators of marketing channels (Gudonavičienė R. & Aljosiene S. 2008, P. 74). The modeling of marketing channels requires the analysis of consumer's needs, to set the objectives of the marketing channel, the identification of the main alternatives of the marketing channel and their evaluation (Kotler P. & Armstrong G. , 2011, p. 351). Many companies want to follow the international sales through advanced communication, in the diplomacy aspect through business links, international agreements, and in the technology aspect as well, through telecommunication and transport, advanced communication by designing the channels for the international business (Laurvick J. 1999, p. 1). The design of channels through international perspectives should be seen as a development of alternative structures of channels for international distribution that are defined by the special approaches for international involvement of marketing. The foreign production asks from the corporations strategic considerations of the levels that go beyond the scope of channels design. **Indirect exportation** means that a firm sells its products in foreign markets, but doesn't have a separate division inside its organization, by not making a considerable effort in the field of international marketing. **Direct exportation** means that the producer takes direct initiative in the export and delegation of duties for others for direct export, to make market contacts, market research, training, physical distribution, to prepare the export documentation, prices and many other duties that will be taken by the department of export itself. **The selection of an appropriate structure** means to choose the best alternative for the distribution in foreign markets (Bert R. 2004 & 2013).

### The motivation of the local and international channel members

Motivation is important so that the channel members will agree on acting as mediators, and share their commitment and sources for the producing lines. The key to an effective motivation is to understand the needs and problems of the channel members (Osman L. & Eestgerd M. , 2008, p. 11). The three main aspects of the motivation for channel members are: 1. The recognition of the needs and problems of channel members; 2. To offer support to them in accordance with their problems and needs; 3. To ensure leadership through effective use of channel power (Bert R. 2004 & 2013, p. ). The relations between the channel members are an increasingly important source in creating competitive advantage (Björkman M. ,2011, p. 1).

## Research results

In countries going through transition like Kosovo, we can note a degree of non-effectiveness of distribution channels. Therefore, in this context, in an advanced market economy the international channels of marketing are becoming more important. Kosovar enterprises are giving attention to building stabile relations between international and local members.

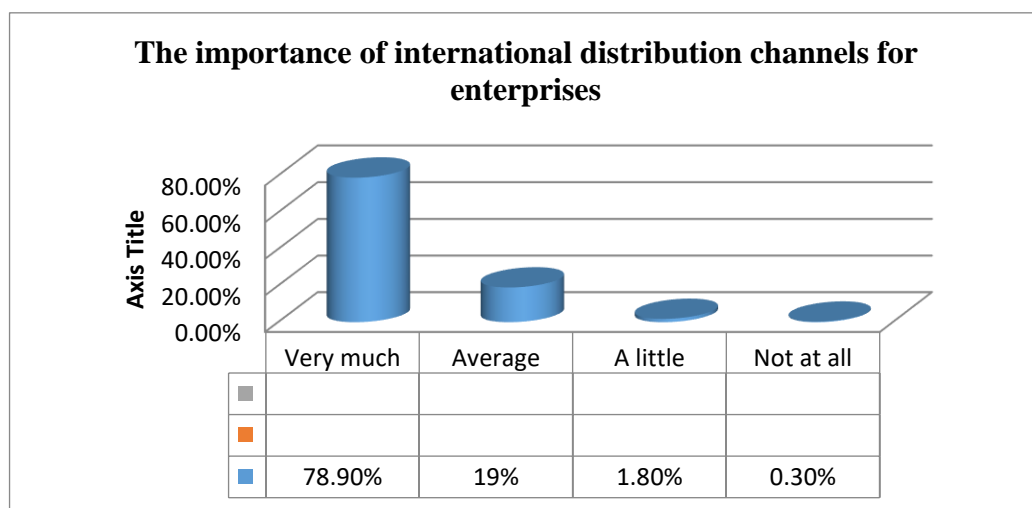
Table 1. The importance of international distribution channels

The importance of international distribution channels for enterprises	%
Very much	78.9 %
Average	19 %
A little	1.8 %
Not at all	0.3%
	100%

Source: the evaluation of authors based on the research results

From the interviewed enterprises 78.9% of the respondents said that international channels are very important, 19% of them said that their importance is average, 1.8% said that they are a little important and and only 0.3% said that they don't matter at all.

Chart 1. The importance of international distribution channels



Source: the evaluation of authors based on the research results

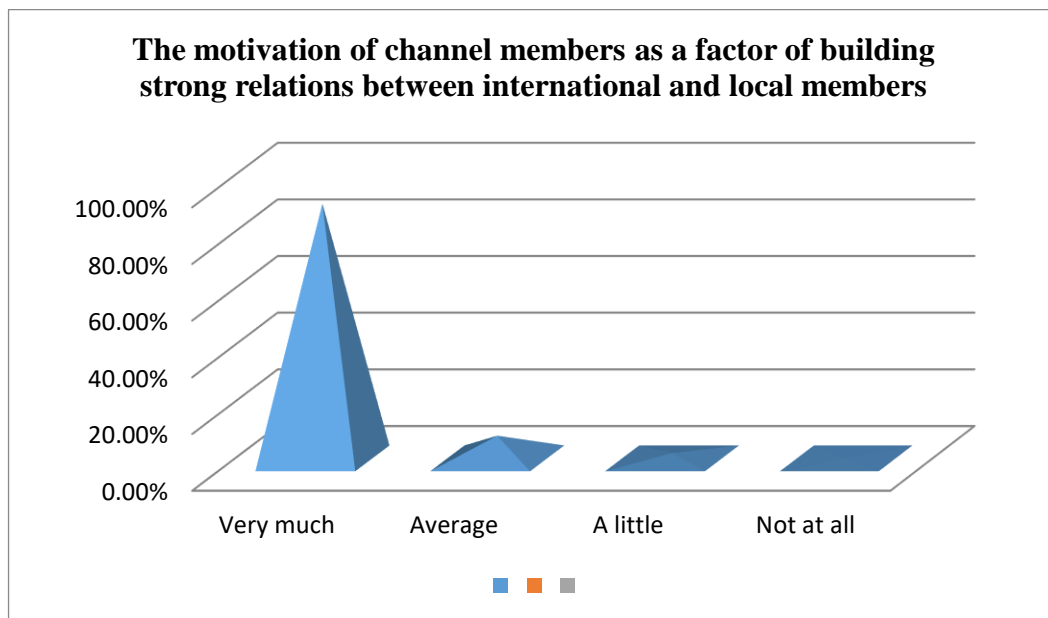
Table 2 - The motivation of channel members as a factor of building strong relations between international and local members.

The motivation of channel members as a factor of building strong relations between international and local members	%
Very much	89.9%
Average	8%
A little	1.9%
Not at all	0.2%
	100%

Source: the evaluation of authors based on the research results

The motivation is an important factor for the channel members to reach agreement on acting as mediators, in order to share their engagement and the available resources. From the interviewed enterprises we notice that motivation has an impact on solving the problems between channel members. From the respondents, 89.9% said that the motivation of channel members is very important in building strong relations between international and local members, and only 0.2% said it didn't have any impact at all.

Chart 2. The motivation of channel members as a factor of building strong relations between international and local members



Source: the evaluation of authors based on the research results

The changes in the market's structure and the globalization of markets are issues that have attracted the attention of many enterprises that deal with distributing the goods and services inside and out of the country.

Table 3. The streamlining of distribution and market's globalization

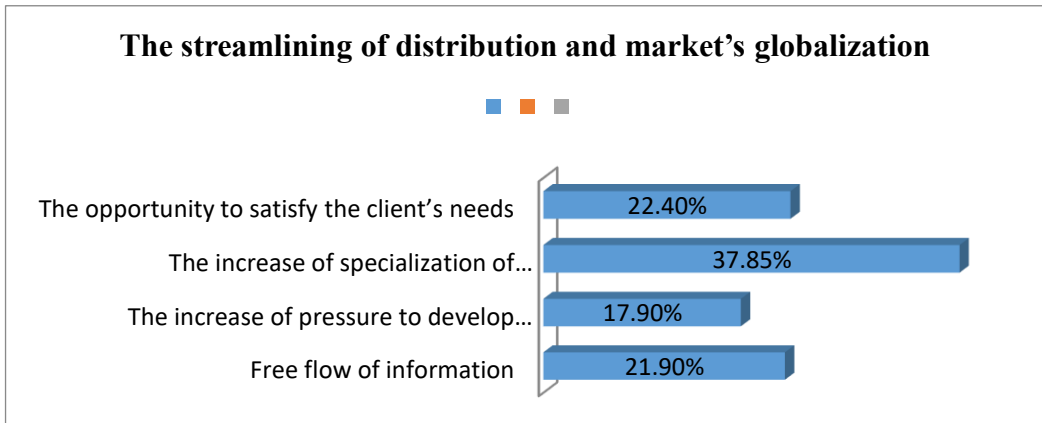


<b>The streamlining of distribution and market's globalization</b>	<b>%</b>
Free flow of information	21.9%
The increase of pressure to develop communication with the countries of the region and Europe	17.9%
The increase of specialization of distribution channels for goods and serviced beyond the national borders	37.85%
The opportunity to satisfy the client's needs	22.4%
	100%

Source: the evaluation of authors based on the research results

From the table results we can see that the streamlining of distribution for the kosovar enterprises in 37.85% has brought higher specialization in the level of the distribution of goods and services through national and international borders, 22.4% could satisfy they client's needs and, 21.9% have increased the free flow of information, 17.9% have increased the pressure to develop communication with the countries of the region and Europe.

Chart 3. The streamlining of distribution and market's globalization



Source: the evaluation of authors based on the research results

Many Kosovar enterprises have profited from their experience in the international marketing field that has had a positive impact in designing strategies and tactics of development plans in the field of distribution.

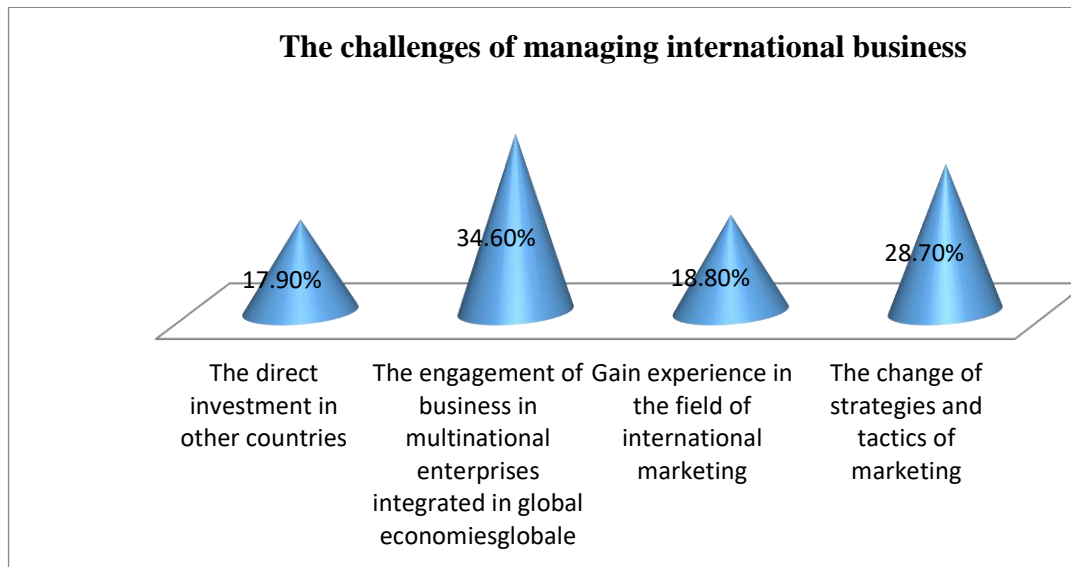
Table 4. The challenges of managing international business

<b>The challenges of managing international business</b>	<b>%</b>
The direct investment in other countries	17.9%
The engagement of business in multinational enterprises integrated in global economies	34.6%
Gain experience in the field of international marketing	18.8%
The change of strategies and tactics of marketing	28.7%
	100%

Source: the evaluation of authors based on the research results

From the table we can see that for 34.6% of the interviewed enterprises the main challenge of managing the business is the engagement of business in multinational enterprises integrated in global economies, for 28.7% the main challenge is the change of strategies and tactics of marketing, for 18.8% it is the to gain experience in the field of international marketing and for 17.9% it is the direct investment for operations in other countries.

Chart 4. The challenges of managing international business



Source: the evaluation of authors based on the research results

From the interviewed enterprises we can see that the organization of sales is realized through telephone and internet, retailers, wholesalers, distributors and market alliances.

Table 5. The design of distribution channels through international perspectives and international distribution

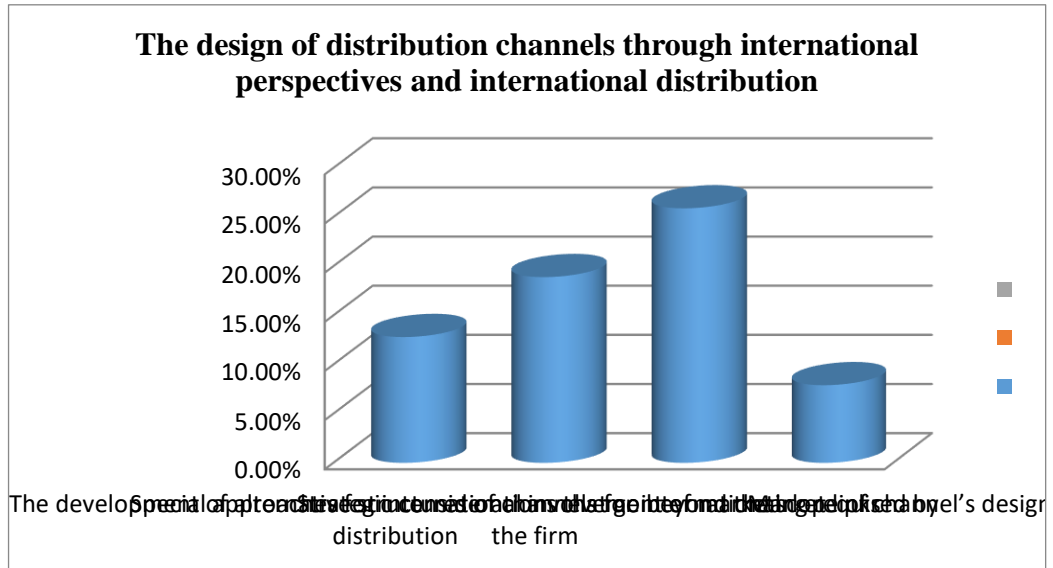
The design of distribution channels through international perspectives and international distribution	%
The development of alternative structures of channels for international distribution	12.8%
Special approaches for international involvement of marketing required by the firm	18.9%
Strategic considerations that go beyond the scope of channel's design	25.9%
Market links	7.9%
International agreements on technology, telecommunication and transport	28.4%
Advanced communication	6.1%
	<b>100%</b>

Source: the evaluation of authors based on the research results

Based on the table we can see that 28.4% of the kosovar enterprises see the design of distribution channels from the international perspectives as an international agreement in the aspect of technology, telecommunication and transport, 25.9%

9% see it as a strategic consideration that goes beyond the scope of channel's design, 18.9% see it as a special approach for international involvement of marketing required by the firm.

Chart 5. The design of distribution channels through international perspectives and international distribution



Source: the evaluation of authors based on the research results

### Conclusions and recommendations

The international marketing include business activities designed to plan, to stir up fares, to direct the goods and services of the company for the consumers in the international level. At the other extreme, the distribution channels at countries in development can be spread, not effective or don't exist at all. Therefore it is a challenge of business management to develop effective cooperation between channel systems in national and international markets and the integration of enterprises in global economies. We recommend further research on designing distribution channels in national and international levels and the creation of a guide for the development of marketing strategies from the producers. The use of many types of resellers in a channel, by using transversal and direct international channels and the design of the strategy for the management of conflicts in the channel and the modeling and design of international distribution channels.

It is recommended for the kosovar enterprises to raise the opportunities to:

- Higher specialization in the level of distribution;
- Wider communication between the countries of the region and Europe;
- The dissemination of information that would enable the free flow of goods through national and international borders;
- Reorganization of distribution and the globalization of markets;
- The design of distribution channels through international perspectives.

### List of References

- 
- Bert R. (2004 & 2013) Marketing channels- Drexel University, Thomson, South –western Björkman M. ,2011, "Investigating Channel Push Branding" The Case of Konftel, Umeå School of Business
  - Cateora PH & Gilly M. & Graham J (2011), "International marketing "15th ed. , p. cm.
  - Gudonavičienė R. & Alljosienė S. (2008), "The Specific Features of Marketing Channel Design" ISSN 1392-2785 ENGINEERING ECONOMICS. 2008. No 1 (56) ECONOMICS OF ENGINEERING DECISIONS Includes index.
  - Kotler P, & Armstrong G. , (2011), Principles of Marketing, 14th Edition, Pearson Prentice Hall
  - Laurvick J. 1999, "Channel Management"- Gaining perspective for global distribution, International Business 470 School of Business and Administration University of Washington.
  - Mühlbacher H. & Leihns H. & Dahringerp L. , (2006), "International Marketing: A Global Perspective, Third Edition, High Holborn House 50–51 Bedford Row London WC1R 4LR
  - Munusamy J. & Chelliah Sh. , 2011, "INTERNATIONAL DISTRIBUTION STRATEGY: A CASE STUDY IN MALAYSIA", Business and Management Review 1 (1): 1-18, March, 2011,
  - Onkvisit S. & Shaw J. 2004, "International Marketing" Analysis and strategy, Fourth edition, Simultaneously published in the UK, USA and Canada by Routledge 29 West 35th Street, New York, NY 10001 and by Routledge 11 Neë Fetter Lane, London EC4P 4EE
  - Osman L. & Westgerd M. , 2008, "International distribution channels"- from the perspective of exporting companies, Luleå University of Technology.
  - Schmitz C. & Wagner T. , 2007, p. 5 "Satisfaction in International Marketing Channels: A Local Channel Member Perspective" Journal of Marketing Channels, Vol. 14 (4) 2007 Available online at <http://jmc.haworthpress.com>
  - Segetlija Z. & Mesarić J. & Dujak D. ,2011" IMPORTANCE OF DISTRIBUTION CHANNELS - MARKETING CHANNELS - FOR NATIONAL ECONOMY" University of J. J. Strossmayer, Faculty of Economics in Osijek

---

## Usage of EduBlogs Among Malaysian Secondary School Students

Dr. Arumugam Raman

Yahya Don

Yaakob Daud

University Utara Malaysia

[arumugam@uum.edu.my](mailto:arumugam@uum.edu.my)

### Abstract

*Most of the western countries are used Edublogs successfully in their classroom (Primary Tech, 2015). However in Malaysia the use of Blogs in education is still in its initial stages. This study is to inspect the level of acceptance of this technology, the UTAUT (Unified theory of acceptance and use of technology) model is used to infer individual students' technology acceptance by explaining the variants in Behavior Intention (BI). This study is conducted on 53 Form 4 secondary school students from Kuala Muda District. The students are all studying the same subject (Science) and they are exposed to Edublogs. A set of questionnaire, in the UTAUT Model which is developed by Venkatesh et al. (2003), is used to collect data which is then descriptively analyzed by using IBM SPSS Statistics Version 20 dan SmartPLS 2.0. The findings of the study found that Performance Expectancy (PE) ( $\beta=0.4210, p<0.01$ ), Social Influence (SI) ( $\beta=0.2450, p<0.01$ ) and Facilitating Conditions (FC) ( $\beta=0.1350, p<0.01$ ) have positive influence towards 'Behavioral Intention' (BI). The value  $R^2 = 0.412$  showed that 41.2% of the variants in the application of Learning zone can be explained by Behavioral Intention (BI). The findings of this study which are hoped to help encourage instructors and students to use this technology in their learning and teaching processes have proven that EduBlogs are beneficial and effective for learning and teaching processes.*

**Keywords:** *EduBlogs*, Unified theory of acceptance and use of technology (UTAUT), Performance Expectancy (PE), Effort Expectancy (EE), Social Influence (SI), Facilitating Conditions (FC).

### 1. Introduction

*EduBlogs* are considered to be educational social software which can give students a social presence (Anderson, 2005). Social presence "is correlated with student satisfaction and higher scores on learning outcomes" (Anderson, 2005) and has been defined as the ability to present oneself "to the other participants as real people" (Garrison, Anderson & Archer, 2000). Blogging functions as a means for students to pursue the individual activity of recording their experiences for the purpose of revisiting and reflecting upon those experiences (Xie & Sharma, 2005). While evidence has shown that educational blogging is not a new phenomenon, the use of blogs in teaching and learning in schools is new in Malaysia. Google search confirms that there are limited researches in this area. Therefore, this study is providing an additional literature on blogging in Malaysia schools. The main aim of this study is to identify the acceptance level of Malaysian students towards blogging technology based on proposed UTAUT model. Song and Chan (2008) found that while the acceptance of the use of blogs as learning tool among Malaysian students were encouraging, there are some challenges to be considered when using the blog as a learning tool. Their study also shows that these students are ready to use this tool to be part of their learning atmosphere. However, in order to exploit and leverage the potential benefits of blogging in Malaysian schools the acceptance level should be addressed first. Figure 1 shows the world's most popular education blogging service.

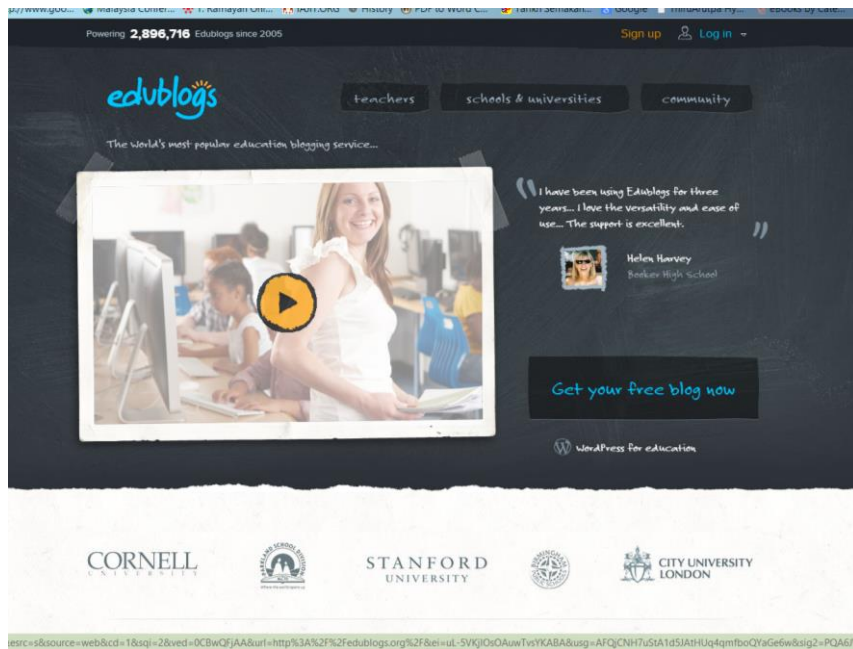


Figure 1 Edublogs. org

## 2. Literature review

Numerous research studies on educational blogging assures healthier learning prospects, encourages communication and collaboration. In their research study on blogging, Williams and Jacobs (2004) pointed out the prospective lies in the fact that blogs offer students with "high level of autonomy" and provides greater opportunity for contact among the students. They also found that the students were highly positive of the use of blogs as a learning tool, increased interactivity and reflective activities. In another noteworthy study, Ferdig & Trammel (2004) intensely proposed that compared to asynchronous discussion forums, blogs are more effective in increasing interactivity that is conversational. The authors added that in this conversational atmosphere, student-teacher liaison is more likely to develop. Active learning and higher order thinking is also improved in this environment. Indeed there have been reports of some achievement across various academic levels (Betts & Glogoff, 2004; Chong & Soo, 2007; Du & Wagner, 2006; Glogoff, 2005; Ramaswami, 2008; Williams & Jacobs, 2004). Still others have reported on how blogging had resulted in students writing more and writing better (Ramaswami, 2008). In fact, blogging has even been stated to have heightened critical thinking and problem-solving skills (Ocker & Yaverbaum, 2001, cited in Kim, 2008).

UTAUT Model is technology acceptance model which was developed by Venkatesh et al. (2003). This model was developed to describe the acceptance of a technology among users. This model describes four main constructs namely; 1) Performance Acceptance which is defined as how far a user believes that using the system can help him or her to achieve a skill in his or her work performance (Venkatesh, Morris, Davis, & Davis, 2003); 2) Effort Expectancy means the level of ease which is related to the use of the system (Venkatesh et al. , 2003); 3) Social Influence which is classified by UTAUT is how far a user believes that a person who is more important than him or her thinks that he or she should use the technology (Venkatesh et al. , 2003); and 4) Facility Conditions that refer to how far the technology ease the organization and how a user believes that the organization and technical infrastructure that exist can support the use of the technology (Venkatesh et al. 2003). The first until the third constructs are the direct determiner for BI and the fourth direct determiner is Use Behavior (UB) that measures the possibility of an individual to use the technology (Venkatesh et al. 2003). The role

of gender which has a strong and permanent basic psychology (Venkatesh *et al.* 2003), age, experience and the voluntary use are claimed to decrease the effect of the four main constructs towards BI. This model has been developed through the study and integration of eight other developed research models which have been used such as The Theory of Reasoned Action (TRA), Technology Acceptance Model (TAM), Motivational Model (MM), Theory of Planned Behavior (TPB), Model Combining the Technology Acceptance Model and Theory of Planned Behavior (C-TAM-TPB), Model of PC Utilization (MPCU), Innovation Diffusion Theory (IDT), and Social Cognitive Theory (SCT).

The research 'Assessing User Acceptance toward *Blog* Technology Using the UTAUT Model' which was conducted by Pardamean and Susanto (2012) found that the e-learning media interactive function is able to attract the students' interest and attention. They have agreed that e-learning media is also suitable for collaboration and shared knowledge. This explains that social factors and environment or Social Influence (SI) is a strong booster for students to use blogs in their e-commerce learning and teaching. In the research 'Interactive Whiteboard Acceptance: Applicability of the UTAUT Model to Student Teachers' by Wong *et al.* (2013), found that teachers get involved in the 'Smart Board' technology when they see the value and benefits. This shows that the policy makers and curriculum designers have to spell out the advantages of using the technology and organize training sessions on how to use it effectively. The high level of Effort Expectancy (EE) will result in high Behavioral Intention (BI) among teachers to use the 'Smart Board' technology. According to El-Gayar *et al.* (2011), in their study 'Student's Acceptance of Tablet PCs and Implications for Educational Institutional Technology & Society', the main determiner towards the acceptance of PC's Tablet is the students' attitude, which is followed by Performance Expectancy, (PE), Facilitating Conditions (FC), Effort Expectancy (EE) and Social Influence (SI).

## 2.1 Hypotheses

Research Hypotheses:

- Ho1: Performance expectancy (PE) has a positive effect towards Behavioral Intention (BI).
- Ho2: Effort expectancy (EE) has a positive effect towards Behavioral Intention (BI).
- Ho3: Social influences (SI) have a positive effect towards Behavioral Intention (BI).
- Ho4: Facility conditions (FC) have a positive effect towards Behavioral Intention (BI).

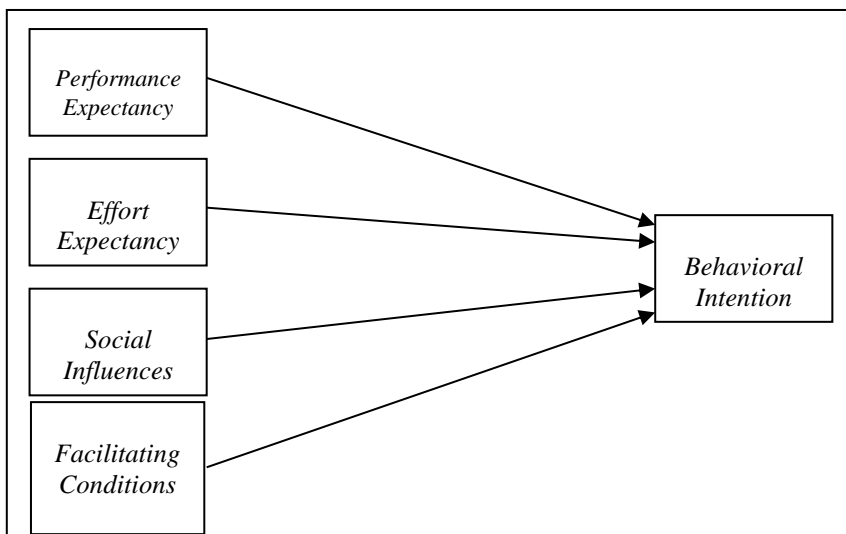


Figure 1 Conceptual Framework of Study

### 3. Methodology

This study is quantitative in nature by using 30-item questionnaire, developed by Venkatesh *et al.* (2003), which consists of Likert 1 – 5 scale from totally disagree (1) to totally agree (5). This questionnaire was translated, validated and distributed to all the participants involved in this study. The sampling for this study consists of 53 Form 4 secondary school students. Each participant is given the questionnaire right after they have been exposed to *Edublogs* teaching and learning in their subject session. The data is then analyzed using IBM SPSS Statistics Version 20 and SmartPLS 2. 0.

### 4. Findings

Table 1 shows the number of respondents involved of which 25 are male (47. 17%) and 28 are female (52. 83%). This shows that the number of respondents differ by 3 (5. 66) between the two genders.

Table 1 Gender of Respondents

Gender	Frequency	Percentage (%)
Male	25	47. 17
Female	28	52. 83
Total	53	100

According to Hair *et al.* (2010), the level of reliability of an instrument is shown when the responses are consistent. Table 2 shows the reliability of each construct. UTAUT Model is reflective in nature and Hair *et al.* (2011) posits that composite reliability (CR) must exceed 0. 7, reliability of items (loadings) must exceed 0. 70, convergent validity (AVE) must exceed 0. 50 and the square root of discriminant validity AVE for each construct must be higher compared to the correlation with other constructs (Fornell- Larcker, 1981).

We used Cronbach's alpha ( $\alpha$ ) coefficient to measure inter item consistency of our measurement items. Table 2 shows the alpha values. The values are above 0. 6 as suggested by Nunnally and Berstein (1994).

Table 2

Cronbach Alpha value  $\alpha$

Construct	Cronbach Alpha $\alpha$
Performance Expectancy (PE)	0. 76
Effort Expectancy (EE)	0. 68
Social Influence (SI)	0. 79
Facilitating Conditions (FC)	0. 71
Behavioural Intention (BI)	0. 84



4.1 *Convergent Validity*

Average Variants Extracted (AVE) is used as general measurement to determine convergent validity for each construct. The AVE value, 0.5 or higher shows that each item completes a part of the item variant. However, an AVE less than 0.5 indicate that, on average, more error remains in the items than the variants explained by the construct.

Table 3 Convergent Validity

Construct		<i>Loadings</i>	<i>AVE</i>	<i>CR</i>
Performance Expectancy (PE)	PE1	0.8650	0.6187	0.9059
	PE2	0.7520		
	PE3	0.8120		
	PE4	0.8910		
	PE5	0.6410		
	PE6	0.7310		
Effort Expectancy (EE)	EE1	0.7810	0.6699	0.9239
	EE2	0.8310		
	EE3	0.7410		
	EE4	0.8610		
	EE5	0.8600		
	EE6	0.8300		
Social Influence (SI)	SI1	0.8621	0.7393	0.9189
	SI2	0.9110		
	SI3	0.8541		
	SI4	0.8091		
Facilitating Conditions (FC)	FC1	0.8010	0.6886	0.9297
	FC2	0.8510		
	FC4	0.7610		
	FC5	0.8740		
	FC6	0.8980		
	FC7	0.7850		
	Behavioural Intention (BI)	BI1		
BI2		0.9240		
BI3		0.7070		
BI4		0.7640		

From Table 3, it shows that loading value (items) exceeds 0. 7 except PE5 and FC4, but PE5 and FC4 are retained because its omission does not increase AVE. However, item FC3 is omitted because the loading is very low (0. 027). Convergent validity exists because AVE for every construct exceeds 0. 50.

Table 4 Construct Correlation Matrix

	Performance Expectancy (PE)	Effort Expectancy (EE)	Social Influence (SI)	Facilitating Conditions (FC)	Behavioural Intention (BI)
Performance Expectancy (PE)	<b>0. 7866</b>				
Effort Expectancy (EE)	0. 6012	<b>0. 8185</b>			
Social Influence (SI)	0. 5112	0. 6036	<b>0. 8598</b>		
Facilitating Conditions (FC)	0. 2132	0. 5136	0. 3270	<b>0. 8298</b>	
Behavioural Intention (BI)	0. 3258	0. 2168	0. 2141	0. 3261	<b>0. 8141</b>

#### 4. 2 Discriminant Validity

According to Fornell dan Larcker (1981), when the average square root of extracted variants exceeds the correlation value between all the variables, then discriminant validity exists (Table 4). From Table 4, it can be summarized that there exists discriminant validity where BI, AVE<sup>2</sup> (BOLD) is greater than correlation indicator in EE, FC, PE and ST. However, in indicator for EE, the AVE<sup>2</sup> is greater than the correlation indicator in FC, PE and SI.

Nevertheless, in the indicator for FC, the AVE<sup>2</sup> (BOLD) is lower than the correlation in the indicator for PE and SI. Consequently, in the indicator for PE, the AVE<sup>2</sup> (BOLD) has become higher again from the correlation in the indicator for SI.

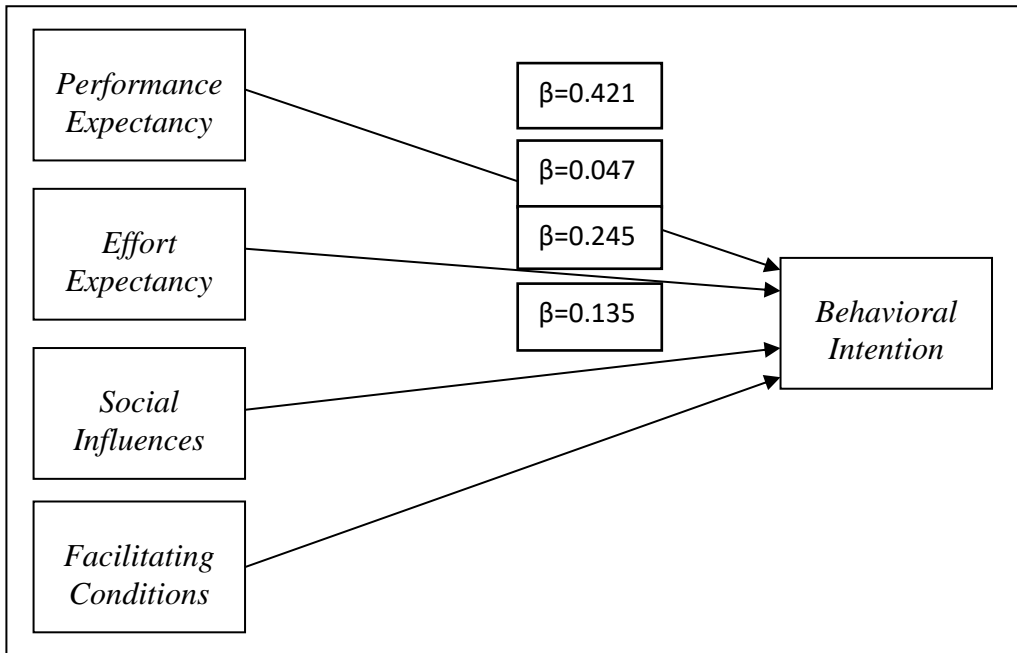
Based on Table 5, it shows that path coefficient ( $R^2$ ) for each construct (latent variable) that shows difference in the level of correlation can be explained. The result shows Performance Expectancy (PE) ( $\beta=0. 4210$ ,  $p<0. 01$ ), Social Influence (SI) ( $\beta= 0. 2450$ ,  $p<0. 01$ ) and Facilitating Conditions (FC) ( $\beta=0. 1350$ ,  $p<0. 01$ ) have positive influence towards Behavioral Intention (BI). Therefore,  $H_{01}$ ,  $H_{03}$  and  $H_{04}$  are accepted, because the value  $R^2 =0. 412$  shows 41. 2% of the variance in behavioral intention can be explained by the extent of PE, EE, SI and FC.

Table 5

Path Coefficient and Hypotheses Results

Hypotheses	Relationship	Coefficient ( $\beta$ )	t value	p value	Result
$H_{01}$	PE $\rightarrow$ BI	0. 4210	2. 6120	0. 0117	Accepted
$H_{02}$	EE $\rightarrow$ BI	0. 0470	0. 2111	0. 8336	Rejected

$HO_3$	$SI \rightarrow BI$	0.2450	3.1240	0.0029	Accepted
$HO_4$	$FC \rightarrow BI$	0.1350	2.566	0.0132	Accepted



## 5. Conclusion

The findings of this study are parallel with the findings in the study done by Pardamean & Susanto (2012) who found that the media interactive function of e-learning can attract the interest and attention of the students. They also agreed that e-learning media is suitable for collaboration and sharing of knowledge. This clearly shows that social and environment factors or SI is the booster for students to use blog in their e-commerce learning. To hasten the implementation of blog in e-commerce learning, encouragement and support from peers is vital. The findings in this study are similar with El-Gayar *et al.* (2011) where they found that the main determiner of Tablet PCs acceptance among students is the students' attitude followed by PE, FC, EE and SI but the result of this study is dissimilar in terms of gender influence in The UTAUT Model which can be seen in the study by Alfonso *et al.* (2012). Their study aimed at testing the gender effect with a sample of 2,175 users of Electronic Document Management System (EDMS) at the Portuguese City Council. The result showed that gender when related to PE with BI proved to have a strong relationship among male than female. However, further research needs to be done with regards to time allotted for the students and also computer skills among the students to get a better picture of the acceptance of *Edublogs* among other students in Malaysia.

Our study was conducted with secondary school students, compared to many other studies which are conducted with graduate students (Betts & Glogoff, 2004; Efimova & de Moor, 2005; Freeman *et al.*, 2006; Hernandez-Ramos, 2004; Xie & Sharma, 2005). Self-disclosure and the establishment of a social presence was one of the primary uses of blogging for the eight students. Other studies have also found that self-disclosure is one of the most common forms of online communication (Joinson, 2001; Joinson & Paine, *in press*). Students showed that they are naturally inclined to disclose personal information, and found that this aspect of social presence encouraged greater involvement in the online

community. Further research may reveal improved strategies for incorporating acts of self-disclosure into online community activities.

## Reference

Afonso, C. M. , Roldán, J. L. , Sánchez-Franco, M. , & Gonzalez, M. de la O. (2012).

The moderator role of Gender in the Unified Theory of Acceptance and Use of Technology (UTAUT): A study on users of Electronic Document Management Systems. *Presented at the 7th International Conference on Partial Least Squares and Related Methods*, Houston, Texas, USA.

Anderson, T. (2005). *Distance learning – Social software’s killer ap?* Paper presented at the Open and Distance Learning Association of Australia, Breaking the boundaries: The international experience in open, distance and flexible education. <http://www.unisa.edu.au/odlaconference/PPDF2s/13%20odlaa%20-%20Anderson.pdf>

Betts, J. D. , & Glogoff, S. J. (2004). Instructional models for using weblogs in elearning: a case study from a virtual and hybrid course. Paper presented at the syllabus 2004

conference, San Francisco, CA, July. Retrieved 05. 01. 09, Available from: <http://download.101com.com/syllabus/conf/summer2004/PDFs/w01.pdf>.

Chong, E. K. M. , & Soo, W. M. (2007). Adaptive learning through blogging: a case study in music teaching. In C. Shegar, & R. A. Rahim (Eds. ), *Redesigning pedagogy: Voices of*

practitioners (pp. 15e31). Singapore: Pearson.

Du, H. S. , & Wagner, C. (2006). Weblog success: exploring the role of technology. *International Journal of Human-Computer Studies*, 64, 789e798.

Efimova, L. , & de Moor, A. (2005). *Beyond personal webpublishing: An exploratory study of conversational blogging practices*. Paper presented at the 2005 Proceedings of the 38th Hawaii International Conference on System Sciences. <http://csdl2.computer.org/comp/proceedings/hicss/2005/2268/04/22680107a.pdf>

El-Gayar, O. F. , Moran, M. , & Hawkes, M. (2011). Student’s acceptance of tables

PCs and implications for educational instructions. *Educational Technology & Society*. 14 (2). 58-70.

Freeman, W. , & Brett, C. Dixon, J. , Kostuch, L. , MacKinnon, K. , McPherson, G. , Paradine, A. , Qiu, M. , & Symington, D. (2006). *Weblogging as a part of academic practice: Reflections on graduate students’ early experiences*. Paper presented at the 2006 International Association for Development of the Information Society Virtual Multi Conference on Computer Science and Information Systems. [http://www.iadis.org/Multi2006/Papers/17/S026\\_EL.pdf](http://www.iadis.org/Multi2006/Papers/17/S026_EL.pdf)

Ferdig, R. E. , & Trammell, K. D. (2004). Content delivery in the 'blogosphere'. *T H E Journal*, 31 (7), 12-20

Fornell C. & Larcker D. F. (1981). Evaluating structural equation models with

unobservable variables and measurement error. *Journal of Marketing Research* 48: 39-50.

Garrison, R. , Anderson, T. , & Archer, W. (2000). Critical inquiry in text-based environment: Computer conferencing in higher education. *The Internet and Higher Education*, 2 (2-3), 87-105. [http://communitiesofinquiry.com/documents/Critical\\_Inquiry\\_model.pdf](http://communitiesofinquiry.com/documents/Critical_Inquiry_model.pdf)

Glogoff, S. (2005). Instructional blogging: promoting interactivity, student-centered learning, and peer input. Available from: Innovate, 1 <http://www.innovateonline.info/>

[index.php?view=article&id=126](http://www.innovateonline.info/index.php?view=article&id=126), retrieved 04. 12. 08.

Hair J. F. , Black W. C. , Babin B. J. & Anderson R. E. (2010). *Multivariate Data*

*Analysis*. 7th Ed. Upper Saddle River, New Jersey: Prentice Hall.

- Hair, J. F. , Ringle, C. M. , & Sarstedt, M. (2011). PLS-SEM: Indeed a silver bullet. *The Journal of Marketing Theory and Practice*, 19 (2), 139-152.
- Hedgebeth, D. (2007). Gaining competitive advantage in a knowledge-based economy through the utilization of open source software', *The journal of information and knowledge management systems*, 37 (3), 284-294.
- Hernandez-Ramos, P. (2004). Web logs and online discussions as tools to promote reflective practice. *The Journal of Interactive Online Learning*, 3 (1). <http://www.ncolr.org/jiol/issues/PDF/3.1.4.pdf>
- Kim, H. N. (2008). The phenomenon of blogs and theoretical model of blog use in educational contexts. *Computers & Education*, 51, 1342e1352.
- Ocker, R. J. , & Yaverbaum, G. J. (2001). Collaborative learning environments: Exploring student attitudes and satisfaction in face-to-face and asynchronous computer conferencing settings. *Journal of Interactive Learning Research*, 12, 427e449.
- Oye, N. D. , Iahad, N. A. , & Zairah Ab. Rabin. (2011). A model of ICT acceptance and use for teachers in higher education institutions. *International Journal of Computer Science & Communication Networks*. 1 (1), 21-40.
- Pardamean, B. , & Susanto, M. (2012). Assessing user acceptance toward blog technology using the UTAUT model. *International Journal of Mathematics and Computers in Simulation*. 1 (6). 203-212.
- Ramaswami, R. (2008). The prose of blogging (and a few cons, too). T. H. E. Journal, Available from: [http://www.thejournal.com/articles/23562\\_3](http://www.thejournal.com/articles/23562_3), retrieved 18. 12. 08.
- Song, H. S. Y & Yuen, M. C. (2008). Educational blogging: A Malaysian university, students' perception and experience. In Hello! Where are you in the landscape of educationaltechnology? Proceedings ascilite Melbourne 2008. <http://www.ascilite.org.au/conferences/melbourne07/procs/song.pdf>
- Venkatesh, V. & Zhang, X. (2010). Unified theory of acceptance and use oftechnology: U. S. vs. China. *Journal of Global Information Technology Management*,. 13, (1), 5-27.
- Ven katesh, V. , Morris, M. , Davis, G. , Davis, F. , DeLone, W. , McLean, E. , Jarvis, C. , MacKenzie, S. , Podsakoff, P. , & Chin, W. (2003): User acceptance of information technology: Toward a unified view. *INFORM MANAGEMENT* 27, 425-478
- Venkatesh, V. , Morris, M. G. , Davis, G. B. , & Davis, F. D. (2003). User acceptance of information technology: Toward a unified view. *MIS Quarterly*, 27 (3), 425–478
- Williams, J. B. , & Jacobs, J. (2004). Exploring the use of blogs as learning spaces in the higher education sector. *Australasian Journal of Educational Technology*, 20 (2), 232e237
- Wong, K. T. , Teo, T. , & Russo, S. (2013). Interactive whiteboard acceptance : Applicability of the UTAUT model to student teachers. *Asia Pacific Edu Res*. 22 (1). 1-10. DOI 10. 1007/s40299-012-0001-9.
- Xie, Y. , & Sharma, P. (2005). Students' lived experience of using weblogs in a class: An exploratory study. [http://ernie.concordia.ca/ra\\_levin/weblogs\\_and\\_higher\\_education.pdf](http://ernie.concordia.ca/ra_levin/weblogs_and_higher_education.pdf)

---

## Formation of linguistic culture of pupils by working with vocabulary

**Doc. Dr.. Kledi Satka (Shegani)**

University of Tirana, Faculty of History and Philology  
Linguistics Department,  
e-mail. kshegani@yahoo.com, tel. 00 355 6922 38 076

**Doc. Dr. Albana, Deda (Ndoja)**

University of Tirana, Faculty of History and Philology  
Linguistics Department,  
e-mail. albanandoja@hotmail.com, tel. 00 355 685398773

### Abstract

*The main purpose of education in the elementary school is that the pupils get the basics of thinking and speech development and to create conditions for the formation of different concepts. For this reason, in this initial period of child's education, it is of first importance the work of vocabulary which is directly connected with the addition of images of the child for the physical and social environment that surrounds him, the exercise of speech and addition of the active reserve of the vocabulary of the pupils. This process essentially realizes the organization of thoughts, multiplies and optimizes social, emotional, communicative and cognitive behavior by mobilizing all the energies of the child and identifying specific trends in the formation of everyone. Highlighting examples from the work of teachers with vocabulary, as a means to stimulate imagination and logical thinking, we will try to analyze the primary role of the culture of the word, which is considered foremost as a precise expression of different images and concepts. The most effective method is exactly the one that gives priority to the continuous and systematic discovery of connections of word and imagination, object and image in order for them to enter the consciousness of pupils not as separate things, but as systematic knowledge of reality and of denominations or ways of saying that serve them to express themselves.*

### From A to Z of the culture of language (from the first letter of the alphabet to the last letter)

Development and learning are the result of the interconnection of the biological maturity and environment, including the social and cultural world where the child lives.

From A to Z of the culture of language, the child progresses to practice new skills gained from experience and motivated by learning through social interaction and relationships with others. Work for establishing pupils' culture of speaking first presupposes continuous perfection of their ability to use the mother language in all forms of its practical implementation, both orally and in writing.<sup>1</sup>

The main purpose of education in the elementary school is that the pupil gets the basics of thinking and speech development and to create conditions for the formation of different concepts. For this reason, in this initial period of child's education, it is of first importance the work with vocabulary, which is directly connected with the addition of images of the child for the physical and social environment that surrounds him, the exercise of speech and addition of the active reserve of the vocabulary of the pupils. Education in fact can not be considered only as a technical issue through which information is processed, it is a complex activity, which tries to adapt the culture with the requirements of members of a society, but on the other hand also adapt their knowledge to the requirements of this culture.<sup>2</sup>

---

<sup>1</sup> Gjokutaj, M., *Gjendja dhe perspektivat e zhvillimit të lëndës së gjuhës shqipe në shkollën tetëvjeçare, në "Kurrrikula dhe shkolla", Gjuhë shqipe dhe leximi letrar*, 5, Tiranë, 2003, f.62-82.

<sup>2</sup> Bruner J., *La cultura dell'educazione, nuovi orizzonti per la scuola*, Fetrineli Editore, 2000, faqe 56

---

Work with dictionary should be extended to all subjects. This is for the simple reason that the contact of children with the language of books leaves multiple traces and sometimes we encounter mechanical use of words or analogous construction of nonexistent words. For example a child, after hearing the tale of shark "peshkagen", addressed teacher with the words: "Now tell us a tale with "peshkamace". Such examples show that in the first two years of elementary school, children are still associated with a talk where frequently are used words that do not express their imagination, sometimes even contradict the linguistic facts. The semantic link of the word star (like orb: Morningstar, the stars are in the sky; the star as a symbol of a five-corner sign: the starfish, it is a star "is beautiful", was born with a star "lucky") is among the simple links, but for a child it is not so simple to make the linguistic link be responsive to his imagination. The child who already knew the word star like orb that looks only at night, listening to the starfish word asked the question: *why was night at the sea?*

The child is thus expanding the meaning of the words already learned. For example, he may have learned the word "first" because he himself is in the first class. Now, he is learning that the same word can have other meanings, such as to be first in the queue, or the first letter of a book. In its entirety, the system of understanding of the child, thus the semantics, not only grow in size, but also deepens the meaning at the same time.

### Word and image

Lexicon can be considered as a kind of "mental dictionary" in which a person has stored the words from an early age, the amount of which increases progressively over the years. From this "dictionary" we take whenever we need the word and put it in the right lexical and semantic context. According to Bruner, intellectual development is influenced by the way in which human beings gradually learn to present the world through action, image and symbol<sup>1</sup>.

The most effective method is exactly the one that gives priority to the continuous and systematic discovery of connections of word and imagination, object and image in order for them to enter the consciousness of pupils not as separate things, but as systematic knowledge of reality and of denominations or ways of saying that serve them to express themselves. The culture of speech is therefore, first and foremost, the precise expression of various images and concepts. From the observed examples we have noticed that children have established with the language a report, which in its early stages passes through notional grammar, which is the frame of reference within which the child starts to move by dealing with language. According to Deon,<sup>2</sup> the starting point is the so-called "notional grammar", exactly the grammar which consists of basic concepts that are close to the child (movement, time, eating, etc. ), and serve as points of reference in linguistic logical flow while the child reaches its full disposition, transmitting meanings that are channeled according to available means of a language and to child development in its linguistic environment.

Child's personality, his intelligence and expressive language are developed step by step in conjunction with adults, peers and the environment where he is living. Efforts for culture of speech are in fact attempts for the culture of child's thinking, for the education of his images and imagination.

Relying on intuitive knowledge of the child is important for two reasons: the first is the motivation: when children have their own theories about the process, means that they are interested in the problem in question and have overcome the stage of a simple description of the problem. The second relates to the value of education in the development of thinking of a child; towards a logical understanding.

Practice has shown that generally in the children of first classes there are quite a lot of discrepancies between the word and its imagination. Sometimes children have images, but not enough words to express. This is because the word is learned without knowing the meaning or it is connected with an inaccurate and incomplete image.

To enrich the vocabulary of pupils, it is important the course of knowledge of nature, through which children become acquainted with nature, environment and society, even through concrete observations, excursions and experiments, so that for each new word, pupils form strong links with what it is called. Thus, there is the possibility to have complete sensations and perceptions of objects, objects and their properties. When the pupil has never seen an object, it is difficult or impossible to visualize it.

---

<sup>1</sup> Bruner J., La cultura dell'educazione, nuovi orisonti per la scuola, Fetrineli Editore, 2000

<sup>2</sup> Deon V., La grammatica suggerita dai bambini *nè Italiano e Oltre* Nr. 4, 1993

It is clear that the teacher to expand the vocabulary of pupils must rely on the experience of the pupils, in familiar things to them, but always, this experience or knowledge of the essence and characteristics of various items must be enriched with other knowledge. The more obvious are the images of objects that pupils study the stronger and the stable will be links of the word with its meaning, and the greater will be the opportunities for uses of figurative and semantic extensions of the type of polisemy. This regards, of course, to the fact that the recognition of nature, of its objects and phenomena is endless; it is added and continuously enriched with new details, through which also comply the related names. Thus for example the words: bear, roaring, fences teeth, tearing etc. children may have heard and learned even before they enter school, through their parents' stories, tales, conversations with adults etc. but their understanding get clear only when they visit the zoo, or see a teaching movie etc. where they notice specifically what they have heard of it.

Another way is reliance in the description given in the dictionary of Albanian language, in presenting their similarities and differences from other types of relevant gender. In this case it is child's imagination to perform the connection of new meanings to those well known, so it happens often that images for new objects are not be the same for all pupils in a class, they differ, being close or far from the truth, depending on the clarity of the explanation presented, but also the experience of personal knowledge of each one. Thus for ex. in the course of the Knowledge of Nature the pupils faces the phrase spaceship. Different pupils in different areas visualize this word in different ways, depending on the knowledge and experience acquired previously. Those who live in coastal cities, of course, have a better knowledge of ships, their size and type, hence the name of the new spaceship is for them more accessible to the imagination; this can be said for those who have seen the documentary and films concerning sea, ships etc. , and is quite elusive for those residing in different areas, non close to the coast, especially in remote mountain areas.

In cases like this, when the child's is enriched with new words through the mediated images, illustrations are an important element in the enrichment of child's vocabulary. This relates primarily with the generalized character of different denominations. For example the word animal used in the course of Knowledge of Nature should be understood by children as comprising all kinds of animals, wild or domestic, although they can be very different from the appearance, size and way of living.

Thus, knowledge of nature is the course through which pupils enter deeply into polisemy and homonymous and synonymous richness of Albanian language.

Words such as: world, block, bloom, subject, leaf, smell, etc. . , should take all their breadth of meaning, so that the name is associated with clear images. For the meanings of the verb *bloom* "cel" are effective compound words such as: *çel derën*, *çelin lulet*, *çelem në fytyrë*, *çelën zogjtë*, *çeli koha* etc.

Of course that explanation of the meanings and the difference between them will not be so metalinguistic, but mainly through getting free compound words or sustainable typical for the respective meanings.

Exactly by phrases and sentences which consist of compound words that are of interest us, the child not only knows polisemy of words, but also the penetration of figurative expressions and of different shades of stylistic value. Thus for example for the word *erë*, (smell/wind) through sentences in which it is contained: a strong wind blows; autumn wind, windy spring; smell the flower; good smelling, stink; etc. , it is made the distinction of its first meaning "wind" from the second meaning: "fragrance"; on the other hand, precisely through compound words that explain the second meaning, fragrance (as good smell, stink, flower smell) it is created the opportunity to understand the phraseology "it smells" "the trick is understood, the secret is revealed".

## Conclusions

In conclusion to the discussion and examples that we brought above, we can say with conviction that **the language of children should be considered as the foundation of formatting a human personality, which runs from stuttering and baby-talk to the imagination and processed and logical thinking**. Nowadays, everywhere in the world, and also in Albania, as a result of increased incentives of "electronic discourse" (games with sounds, words, and musical sounds etc. ) and the cartoons that are provided by television channels, videotapes or DVDs, it is observed an acceleration of the overall mental and linguistic development of children.

It is necessary to expand more the concept of forming linguistic culture to pupils considering these basic directions:



- a) Enriching morphological system of speaking to pupils with a sufficient amount of different parts of the lecture (*names, adjectives, verbs, pronouns, adverbs, prepositions, conjunctions, particles, exclamations*);
- b) Processing and clarification of difference between the words of the same root and words with similar roots;
- c) Enriching pupils' speaking, i. e. recognition of such categories of words such as synonyms, antonyms, homonymy, epithets, comparisons, phraseology and sustainable compound words equivalent to a word or term etc.

This process essentially realizes the organization of thoughts, multiplies and optimizes social, emotional, communicative and cognitive behavior by mobilizing all the energies of the child and identifying specific trend in the formation of everyone.

## Literature

Shkurtaj, Gj. , (2003) Sociolinguistika, SHBLU ,Tiranë.

Shkurtaj Gj. (2004) *Etnografi e të folurit të shqipes*, SHBLU, Tiranë.

Jerome,B. , (2002), *La cultura dell'educazione, nuovi orisonti per la scuola*, Fetrineli Editore.

Marazzini C. , (2001) *Il perfetto parlare. La retorica in Italia da Dante a Internet*, Roma, Carocci.

Deon V. , (1993) *La grammatica suggerita dai bambini në Italiano e Oltre Nr. 4*.

Pontecorvo, C. , Ajello, A. M. Zucchermaglio, C. (1995). *I contesti sociali dell'apprendimento. Acquisire conoscenze a scuola, nel lavoro, nella vita quotidiana*, Milano, Ambrosiana.

Fishman J. , (1965) *Who speaks, what language, to whom and when*, "La linguistique"<sup>2</sup>.

Koutsouvanov, E. , (1993) *Television and child language development*, International Journal of Early Childhood 25 f. 27-32.

Buzan, T. , (2006) *Truri i fëmijës*, Botimet "Max".

Gjokutaj, M. , (2003), *Gjendja dhe perspektivat e zhvillimit të lëndës së gjuhës shqipe në shkollën tetëvjeçare, në "Kurrikula dhe shkolla"*, Gjuhë shqipe dhe leximi letrar, 5, Tiranë.

---

## The Relationship between Culture and Organizational Commitment among Chinese primary School Teachers

**Arumugam Raman**

Universiti Utara Malaysia  
arumugam@uum.edu.my

**Lim Tse Ying**

Universiti Utara Malaysia  
lim1706@yahoo.com

**Rozalina Khalid**

Universiti Utara Malaysia  
rozalina@uum.edu.my

### Abstract

*The purpose of this study is to identify the relationship between school culture and organizational commitment. The study focused on twenty three Primary Chinese Schools (SJKC) in Kota Setar, Kedah, Malaysia. 200 teachers were randomly selected to be the respondents where they were asked to complete the School Culture Inventory (SCI) (Maslowski, 2001) questionnaire to test the school culture while Organizational Commitment (OC) (Meyer & Allen, 1990) to examine teachers' commitment. Descriptive statistics of the SPSS (Statistical Package for the Social Sciences) version 19.0 were used to analyze the data to determine the frequency, percentage, mean and standard deviation. Using Alpha Cronbachs, the reliability test of the instrument is 0.90. To test the school culture and organizational commitment, statistical methods, descriptive and inferential statistics were used. Data collected was found to be not normal (K-S test) where Spearman correlation  $p \leq 0.05$ . Findings indicate that school culture is related to organizational commitment. Dimensions of human relations, open system, rational goal, internal process showed positive and significant relationships with organizational commitment, thus, proving that school culture is a predictor of organizational commitment.*

**Keywords:** School Culture, Organizational Commitment, Chinese Primary School

### 1. Introduction

To materialise Mission 2020, the important aspect that needs to be addressed is the schools' organizational culture, teachers' commitment and school efficacy (Education Development Blueprint 2006-2010, 2007). Previous researches done showed the factor that impedes school success is the school organizational culture (Hopkins, 2005). Thus, in order to increase the quality of education we should focus on this factor.

Although similar curriculum is used throughout the schools in Malaysia, the school culture between the schools still differ. According to Marimuthu (1990), school culture consists of values, beliefs, knowledge and traditions, thinking styles and behaviours which are different from other social institutions. So, although schools are provided with the same infrastructure and work force the achievements of the schools still differ (Sharifah Md Nor, 2000; Huberman, 1992; Bolman & Deal, 1991). This proves that school leadership plays an important role in determining school culture (Sergiovanni, 2000; Deal & Peterson, 1999).

The performance of a school relates closely to teachers' high commitment for without it, the schools's target will be difficult to achieve. The effectiveness of teaching and learning depends on teachers' quality (Abdullah dan Aion, 2005). Teachers who are highly committed will ensure that every tasks delegated are completed successfully. Teachers' commitment is related to work performance and the ability to create and consolidate new ideas in their teaching, having influence on their students' achievement, and teachers' attitude towards the school (Tsui & Cheng, 1999).

Studies about school culture in Malaysia and effective schools are still scarce (EPRD, 2004). Although studies conducted overseas are vast, majority are empirical qualitative studies and thus the data collection are from small schools (Colley, 1999; Kelley & Bredeson, 1987). Other studies on school culture only focussed on comparison between secondary schools (Cavanagh & Dellar, 1998; Pang, 1996). Therefore, this study aims to identify the school climate or culture at a primary chinese school (SJKC) in the district of Alor Setar and its relationship with teachers' commitment towards the school.

A study by Pang (1998) focussed on school culture in secondary schools in Hong Kong. Pang (1998) identified the school culture profile based on the composite score on four variable; bureaucratice relationship, culture relationship, authoritarian monitoring and laidback monitoring. However, Pang (1998) did not analyze the profiles to identify types of secondary school cultures. Thus, this study tends to explore the existence of types of secondary school cultures. The knowledge about school culture and values is vital. Schools can use this study to identify their own school cultures and display values that work towards their school success. If school cultures are identified, school administrators will be able to plan and implement appropriate actions to improve their schools.

Commitment also relates to the achievement of the organization's aims (Mintzberg, 1989). An effective should have committed teachers towards achieving the school's vision and mission. A study by Kushman (1992) showed that there is a strong relationship between commitment and school culture, collaboration and school climate. Nir (2002) stated that teachers' commitment is also related to the efficacy of the school, work performance, work satisfaction and students' achievement. Committed teachers are more motivated to work towards change and are responsible (Firestone & Pennell, 1993) more sensitive, dedicated and diligent (Elliot & Crosswell, 2003). Therefore, this study will focus on school culture and teachers' commitment of SJKC.

## 1.1 Objectives

The objectives of this study is to identify the school culture based on the dimensions such as human relation, open system, rational goals and internal process in SJKC in the district of Alor Setar in Kedah. This study also aims to examine the relationship between school culture and teachers' commitment.

- i.*To identify school culture dimensions at SJKC in the district of Alor Setar in Kedah.
- ii.*To identify the relationship between school culture and organizational commitment.

## 2. Literature Review

Fullan dan Hargreaves (1996) defines culture as beliefs, assumptions, and hope in terms of school operations. School culture is also defined as school beliefs and values that are shared together or agreed upon as true and accurate Hobby (2004). School culture aspects can be identified through similar content and strength (Maloswki, 1993). Content refers to basic assumption meaning, norms, and values shared together by the school community.

According to Pang (2006), the strength of a culture is a combination of a clear definition of values and the level of values and norms practices. The strength of a culture relates to the social control that suits the school's values and norms. A weak school culture generates teachers who only follow the set guidelines and do not act innovatively. A strong school culture will influence various values, norms, beliefs, symbols, traditions and language which will color the students' future. The school community has to be exposed to and practice good and effective moral values in line with the National Philosophy of Education (NPE) (Asmawati Suhid, 2005). School culture has to be identified and understood so as to increase school's performance and achieve the NPE objectives (PIPP 2006-2010, 2007).

Ng (2006) who conducted a school culture study in a normal primary school (SK) and SJK in Malaysia found that SK schools display hierarchy culture compared to SJK. The findings showed that younger teachers in SK respect their seniors, are

humble and respectful; and maintain the good name of their schools. On the other hand, in SJK the teachers were more individualistic, selfish and outspoken although they know their words may hurt others and cause conflict.

Deal and Kennedy (1982) and Peters and Waterman (1982) suggested that the culture of an organization gives a great impact on the organization especially in terms of performance and commitment. Teachers' commitment is identified as one most critical factors to determine future performance of education and schools (Huberman, 1993). Teachers' commitment is related to work performance and the ability to create and consolidate new ideas in their teaching, having influence on their students' achievement, and teachers' attitude towards the school (Tsui & Cheng, 1999). To maintain the energy and the working spirit, teachers should uphold their personal commitment towards work (Day, 2004).

There is positive relationship between organizational culture and organizational commitment among the Chinese community in Taiwan according to a study by Chow et al (2001). The dimensions such as innovation, aggression, respectful, and stability showed a strong relationship with commitment and work satisfaction. Team work showed average relationship. A study by Ritche (2000) showed that organizational culture has an influence and effect on the performance of an individual and organization.

There is positive relationship between secondary school teachers' commitment with school culture according to Jones (1998). 11 schools in New Jersey were tested by Jones (1998) to examine the relationship between commitment and school culture by involving the school administrators and teachers as respondents. The result showed that the relationship between variables such as loyalty, work environment, happiness, and information sharing among colleagues have positive relationship with commitment.

Three factors that influence teachers' commitment in schools are personal, school and system (Elliot dan Crosswell, 2001). Personal factor refers to personal daily life. Professional factor denotes to the importance of involvement and responsibility towards the profession. School factor relates to positive relationship with colleagues and the feeling of ownership while system factor refers to control, support, and teachers' influence towards the reform processes done. Lack of support from colleagues, students'parents and school administrators may influence teachers' commitment. It is difficult to be in schools that do not support change and development (Elliot & Crosswell, 2001).

Lee et. al. (2010) suggested the orientation of school aims as an important factor that affects teachers' commitment. The relationship between the teachers, especially a collaborative relationship is one important factor suggested by several researchers in their studies on school culture and teachers' commitment ( Paine dan Ma, 1993 ). The result findings of the study done by Wang et. al. (2007) showed that school culture affects teachers' commitment towards the school. Therefore, if a school increases the strength of its school culture, teachers will increase their loyalty. The literature review showed that the role of school culture is closely related to teachers commitment. The variables that relates to school culture have significant relationship on teachers' commitment towards school. The researcher aims to identify the relationship between school culture and teachers' commitment towards school.

There are five null hypotheses that will be studied here.

- Ho1: There is no significant relationship between school culture and teachers' commitment.
- Ho2: There is no significant relationship between human relations dimension and teachers' commitment.
- Ho3: There is no significant relationship between open system dimension and teachers' commitment.
- Ho4: There is no significant relationship between rational goal dimension and teachers' commitment.
- Ho5: There is no significant relationship between internal process dimension and teachers' commitment.

### 3. Method

Since this study involved a huge number of respondents and there were differences between schools, a quantitative approach was suitable to be employed Pang (2006). Stratified random sampling was appropriate for mixed populations because this method could reduce the sample error, decrease variants, and give correct assumptions (Gorard, 2001), a less sample count and nearly represent a perfect population (Johnson & Christensen, 2004). Size Determinant Table for

educational research activities built by Krejcie and Morgan (1970) was used to determine the research sample and 228 teachers chosen from among several SJKC in the district of Kota Setar through simple random sampling were used as research sample.

To identify the school culture dimensions which focus on organizational efficacy values, questionnaire constructed by Krejcie dan Morgan (1970) was employed whereas to examine teachers' commitment Organizational Commitment (OC) (Meyer & Allen, 1990) questionnaire was used. Section A consisted of teachers' personal information such as gender, marital status, age, ethnic group, years of teaching experience, years of teaching in the school and level of education. Section B involved 4 school culture dimensions which contained 10 to 11 items for each dimension (human relationship (1-11), open system (12-21), rational aims (22-31), internal process (32-42) and five options were given; Never (N), Very Seldom (VS), Seldom (S), Often (O), Very Often (VO). Section C dealt with teachers' commitment which involved 24 items based on Organizational Commitment (Meyer & Allen, 1990) questionnaire. 5 Likert scale was given; 1= Disagree (D), 2= Slightly Disagree (SD), 3= Slightly Agree (StA), 4= Strongly Agree (StA) and 5= Very Strongly Agree (VSA).

The pilot study was conducted at an SJKC in the district of Kubang Pasu to test the validity of the instrument. 45 teachers completed the questionnaire and data analysis showed Alpha Cronbach Coefficient Value ( $\alpha$ ) = 0.95 which meant the instrument was suitable to be used in the real study.

### 3.1 Data Collection

After attaining the approval to conduct the study from EPRD and from the Education Department in Kedah, the researcher distributed the research instruments to the selected schools together with the documents listed below:

1. Letter to the Principal/Headmaster
2. Letter to the Teachers
3. A copy of approval letter to conduct the research

The respondents were given seven days to complete the questionnaire. Data collected was analysed by using SPSS (Statistical Package for the Social Sciences) version 19.0. To describe sample characteristics and school culture dimensions, frequency, average, standard deviation, and percentage were used. Anomaly test were also conducted. Spearman Correlation test were used to identify the relationship between school culture and teachers' commitment.

## 4. Results

### 4.1 Demographic Information

Research sample needed was 228 SJKC teachers in the district of Kota Setar. Although 240 sets of research instruments were distributed, only 210 were returned with the return rate of 87.5%. But only 201 questionnaires could be analysed. Descriptive analysis was used to explain the respondents' information in terms of gender and marital status. Based on Table 1, there were 18 male teachers (9.0%) and 183 female teachers (91.0%) involved.

**Table 1** Respondents' distribution based on gender

Gender	Number of respondents	Percentage (%)
Male	18	9.0
Female	183	91.0
Total	201	100.00

Table 2 shows the mean result of the overall culture which is 4.31. Human relationship has the highest mean value which is 4.49. The mean for other dimensions are high; with human relationship (4.49) the highest, open system (4.23), rational aims (4.07), internal process (4.43).

**Table 2** Mean and Standard Deviation for school culture

School Culture Dimensions	Mean	SD
Human Relationship	4.49	0.60
Open System	4.23	0.37
Rational Aims	4.07	0.45
Internal Process	4.43	0.75
Overall	4.31	0.53

To determine that the data collected is normal, anomaly test was conducted. Table 3 below shows the test result.

**Table 3** Anomaly Test for school culture and teachers' commitment

	Kolmogorov-Smirnov <sup>a</sup>	Shapiro-Wilk
Culture	.000	.000
Commitment	.000	.000

Shapiro - Wilk (W) test was .702 ( $p < .05$ ) for school culture whereas for teachers' commitment Shapiro – Wilk (W) Test was .647 ( $p < .05$ ). From the results, it showed that anomaly was not observed and so Spearman Test was used to test the relationship between school culture and teachers' commitment.

#### 4.2 Hypothesis testing

**H<sub>0</sub>1 : There is no significant relationship between school culture and teachers' commitment.**

Based on Table 4, the correlation analysis using Spearman test finding showed positive significant relationship between school culture and teachers' commitment ( $r = .501, p < .05$ ). This result rejected H<sub>0</sub>1. The analysis finding showed that a

high practice of school culture will result in high level of teachers' commitment. The correlation value between school culture and teachers' commitment was averagely high.

**Table 4** Spearman Correlation between school culture variables and teachers' commitment variables

Variables	Teachers' Commitment	
	Correlation Value (r)	Significant
School Culture	.501**	.000

Hypotheses	Hypotheses Statements	Method Testing	of Correlation Value	Test Findings
H <sub>02</sub>	There is no significant relationship between human relationship dimension and teachers' commitment at SJKC.	Spearman correlation	.998	Rejected
H <sub>04</sub>	There is no significant relationship between open system dimension and teachers' commitment at SJKC.	Spearman correlation	.500	Rejected
H <sub>05</sub>	There is no significant relationship between rational aims dimension and teachers' commitment at SJKC.	Spearman correlation	.502	Rejected
H <sub>06</sub>	There is no significant relationship between internal process dimension and teachers' commitment at SJKC.	Spearman correlation	.502	Rejected

Note:  $p \leq 0.05$

Correlation analysis result using Spearman test in Table 5 showed positive significant relationship between human relationship dimension and teachers' commitment ( $r = .998, p < .05$ ) statistically. This result failed to accept Ho<sub>2</sub>. The high positive relationship showed that a high level of human relationship was able to increase the level of teachers' commitment and vice versa.

The relationship between open system dimension and teachers' commitment was also positive and significant ( $r = .500, p < .05$ ) which also rejected Ho<sub>3</sub>. The result showed that high level of open system practice resulted in high level of teachers' commitment and vice versa. Similarly with Ho<sub>4</sub>, there was positive significant relationship between rational aims and teachers' commitment ( $r = .502, p > .05$ ) which failed to accept Ho<sub>4</sub>. With this, there was an averagely high relationship between both variables. The positive significant relationship showed that high rational aims brought about high teachers' commitment. Finally, the result for Ho<sub>5</sub> was also significantly positive ( $r = .52, p < .05$ ) which showed an averagely high positive relationship between internal process dimension and teachers' commitment. This result failed to accept Ho<sub>5</sub>. The positive significant relationship showed that an effective internal process resulted in high teachers' commitment and vice versa. Overall, human relationship dimension showed a high correlation value  $r = .998$  compared to other dimensions which gained  $r$  value,  $r = .50$ .

## 6. Discussion

This study was conducted to identify the relationship between school culture and teachers' commitment at SJKC in Kota Setar district. This section will discuss the research questions and the findings. There are four school culture dimensions namely human relationship, open system, rational aims and internal process in this study. Overall, the mean score for all the four dimensions were high which exceeded 4 in the 5 Likert scale. The result finding showed that human relationship dimension is the dominant culture in SJKC with the mean value of 4.49.

This finding is similar to the study by Maslowski (2001) in Holland. According to Maslowski (2001), schools in Holland showed a higher score in the human relationship dimension compared to the other dimensions. In addition, the result found is also in parallel with the result by (2003) in a university in the state of Ohio. According to Berrio (2003), the university culture focused on flexibility, human consideration, and sensitivity towards customers.

A journal written by Johnson (2002) also claimed that a small size school can bring about a better school culture. This is due to the fact that teachers are more focused on their students because of the small number of students and they have good relationship with the students' parents. According to Gruener (2005), schools with high human relationship will produce a high number of successful students.

The findings of this study are similar to the study done by Peterson and Deal (1999) who claimed that schools with high culture practice such as having the same goals and display good relationship with the surrounding community will increase teachers' commitment in schools. Peterson (2002) stated that schools with low culture practice will decrease the level of teachers' commitment to increase school achievement. The characteristics of low culture practice such as unclear vision and mission, no cooperation and unfriendly attitude with the surrounding community will decrease teachers' commitment.

Nevertheless, the finding of this study differs from the study findings by Ng (2006) which showed that the culture in SJKC did not emphasize on human relationship and internal process, instead, more focus is given to rational aims and open system. Ng (2006) said that teachers in SJKC are more individualistic in achieving the aims. They are more outspoken although their words might hurt other peoples' feelings and result in conflict. According to Ng (2006), teachers in SJKC are more responsible in undertaking their tasks because by doing so, they will be acknowledged.

Similarly, in a study done by Barth (2002), it was found that the dominant dimension is rational aims. His result finding is similar to the result by Yaakob (2007) who concluded that the dominant dimension in primary schools in Kedah is rational aims such as efficacy values, chasing aims and the success of aims orientation. The finding of this study proved that school culture has positive significant relationship with teachers' commitment at SJKC in Kota Setar district. From this result, research questions have been addressed and explained elaborately.

In materializing Vision 2020, the human capital needed originate from schools. School functions as the main education institution which is responsible to disseminate quality education to the children of our nation. Thus, teachers, as the main player in schools, should increase the quality of our education.

The government has realized that committed teachers will help in materializing the nation mission by practicing good school culture. Thus, school culture has been included in the Malaysian Education Blueprint (2013 – 2025).

The finding of this study has mentioned that human relationship dimension is the dominant school culture. So, school sustenance program, parents' financial resources and EDRP have encouraged the involvement of the PTA and parents in the program organized by the schools. Parents' support and involvement is important towards the success of the school programs and the increase of teachers' commitment.

In conclusion, the government especially the Ministry of Education should give emphasis on school culture which has impact on teachers' commitment. Teachers' commitment will increase if they work in a good school culture. Teaching and learning will become more effective. School excellence will be achieved. The mission and vision of the Ministry of Education will materialize. Thus, education in Malaysia can be at par with other countries in the world.

## References

Abdullah H. & Ainon M. (2005). *Kemahiran interpersonal untuk guru*. Kuala Lumpur: PTS Publications & Distributor Sdn. Bhd-



- Aelterman, A. , Engels, N. , Van Petegem, K. , & Verhaeghe, J. P. (2007). The well-being of teachers in Flanders: The importance of a supportive school culture. *Educational Studies*, 3 (33), 285–298
- Akta Pendidikan 1961. (1984). Kuala Lumpur: International Law Book Service.
- Anderman, Eric M. ; And Others. (1991) Teacher comitment and job satisfaction: The role of school culture and principal leadership. Retrieved from <http://files.eric.ed.gov/fulltext/ED375497.pdf>
- Asmawati, S. (2005). Pengajaran adab & akhlak Islam dalam membangunkan modal. *Jurnal Pengajian Umum* (8), 167-177.
- Barth, R. S. (2002). The culture builder. *Educational Leadership*, 59 (8), 6-11.
- Berrio, A. A. (2003). An organizational culture assessment using the competing values framework: A profile of Ohio State University Extension. *Journal of Extension*, 41 (2), 1-12.
- Bolman, L. G. , & Deal, T. E. (1991). Reframing organizations. San Francisco: Jossey-Bass.
- Cavanagh, R. F. , & Dellar, G. B. (1998). The development maintenance and transformation of school culture. Retrieved from <http://files.eric.ed.gov/fulltext/ED418962.pdf>
- Cheng, Y. C. (1993). Profiles of organazational culture and effective school. *School Effectiveness and School Improvement*, 4 (2), 85-110.
- Chow, M. , Carol, D. , Ruben, L. , & Laurie, O. (2001). School reform organizing in the San Francisco Bay area and Los Angeles, California. Oakland, CA: California Tomorrow.
- Colley, K. M. (1999). Coming to know a school culture. Retrieved from <http://scholar.lib.vt.edu/theses/available/etd-082599-222148/unrestricted/KColley.pdf>
- Cunningham, W. , & Gresso, D. (1993). Cultural leadership: The culture of excellence in education. Needham Heights, MA: Allyn and Bacon.
- Day, C. (2004). A passion for teaching. London: Routledge Falmer.
- Deal, T. E. , & Kennedy, A. A. (1982). Corporate cultures: The rites and ritual of corporate life. Reading, MA: Addison-Wesley,.
- Deal, T. E. , & Peterson, K. D. (1990). The principal's role in shaping school culture. Retrieved from <http://files.eric.ed.gov/fulltext/ED325914.pdf>
- Deal, T. E. , & Peterson, K. D. (1999). Shaping school culture: The heart of leadership. San Francisco: Jossey-Bass.
- Elliott, B. , & Crosswell, L. (2003). Teacher commitment and engagement: The dimension of ideology and practice assocaited with teacherr commitment and engagement within an Australian perspective. Retrieved from <http://eprints.qut.edu.au/968/1/cro04237.pdf>
- Finnan, C. (2000). Implementing school reform models: Why is it so hard for some schools and easy for others? Retrieved from <http://files.eric.ed.gov/fulltext/ED446356.pdf>
- Firestone, W. A. & Pennell, J. R. (1993). Teacher commitment, working conditions, and differential incentive policies. *Review of Educational Research*, 63 (4), 489-525.
- Fullan, M. , & Hargreaves, A. (1996). What worth fighting for in your schools? Retrieved from <http://files.eric.ed.gov/fulltext/ED342128.pdf>
- Gorard, S. (2001). Quantitative methods in educational research: The role of numbers made easy. London: Continuum.
- Gordon, S. P. (2004). Profesional development for school improvement: Empowering learning communities. Boston: Pearson.
- Gruenert, S. (2005). Correlations of collaborative school culture with student achievement. *NASSP Bulletin*, 89 (45), 1-9.

- Hansen, G. and Wernerfelt, B. (1989). Determinants of firm performance: The relative impact of economic and organizational factors. *Strategic Management Journal*, 10 (3), 399-411.
- Hinkle, D. E. ,Wiersma, W. , & Jurs, S. G. (2003). *Applied statistics for the behavioral sciences*. Boston, Mass: Houghton Mifflin.
- Hobby, R. (2004). *A culture for learning: A investigation into the values and beliefs associated with effective schools*. The Hay Group Management Ltd.
- Hollins, E. (1996). *Culture in school learning: Revealing the deep meaning*. New Jersey: Lawrence Erlbaum Associates.
- Hopkins, D. (2001). *School improvement for real*. London: Falmer Press.
- Hopkins, G. (2005). Skilled leadership the key to improving test scores, study says. Education World Inc. Retrieved from [http://www.educationworld.com/a\\_admin/admin/admin188.shtml](http://www.educationworld.com/a_admin/admin/admin188.shtml)
- Hoy, W. K. , & Miskel, C. G. (2008). *Educational administration: Theory , research, and practice* (8th ed). New York, NY: McGraw-Hill.
- Huberman, M. (1992). *Successful school improvement*. Buckingham: Open Univesity Press.
- Huberman, M. (1993). *The lives of teachers* (J. Neufeld, Trans. ). London: Cassell Villiers House.
- Issac, A. F. (1991). High- and low-burnout schools: School culture aspects of teacher burnout. *The Journal of Educational Research*, 84 (6), 325-333.
- Johnson, R. B. , & Christensen, L. B. (2004). *Educational research: Quantitative, qualitative, and mixed approaches*. Boston, MA: Allyn and Bacon.
- Johnson, J. (2002). Do communities want smaller schools? *Educational Leadership*, 59 (5), 42-46.
- Jones, A. H. (1998). Ten points of debate in teacher education. *Teacher Educational Quaterly*, 25 (4), 23-34.
- Juhum, Muhammad. (2013). Hubungan budaya kerja, sikap terhadap kepemimpinan kepala sekolah, dan kepuasan kerja dengan komitmen organisasi guru smp swasta di Kecamatan Beringin Kabupaten Deli Serdang. Retrieved from <http://digilib.unimed.ac.id/hubungan-budaya-kerja-sikap-terhadap-kepemimpinan-kepala-sekolah-dan-kepuasan-kerja-dengan-komitmen-organisasi-guru-smp-swasta-di-kecamatan-beringin-kabupaten-deli-serdang-29358.html>
- Kelly, B. E. , & Bredeson, P. V. (1991). Measures of meaning in a public and in a parochial school: Principals as symbol managers. *Journal of Educational Administration*, 29 (3), 6-22.
- Krejcie, R. V. dan Morgan, D. W. (1970). Determining sample size for research education and psychological measurement. *Education and Psychological Measurement*, 3, 607-610.
- Kushman, J. W. (1992). The organizational dynamics of teacher workplace commitment: A study of urban elementary and middle schools. *Educational Administration Quarterly*, 28, 5-42.
- Lee, O. F. , Tan, J. A. , & Javalgi, R. (2010). Goal orientation and organizational commitment: Individual difference predictors of job performance. *International Journal of Organizational Analysis*, 18 (1), 129–150.
- Macneil, A. , & Maclin, V. (2005). Building a learning community democratic values. Retrieved from [http://cnx.org/contents/43c57343-bcb7-4066-8ac8-8f77d07c8884@2/Building\\_a\\_Learning\\_Community](http://cnx.org/contents/43c57343-bcb7-4066-8ac8-8f77d07c8884@2/Building_a_Learning_Community):
- Manual Kajian Tindakan EPRD. (2004). Putrajaya: Kementerian Pendidikan Malaysia.
- Maslowski, R. (1993). *A systematic approach of organizational culture*. Unpublished master's thesis, University of Twente, Netherlands.
- Maslowski, R. (2001). School culture and school performance: An explorative study into the organizational culture of secondary schools and their effects. Retrieved from <http://doc.utwente.nl/36122/1/t0000012.pdf>
- Maehr, M. L. , & Fyans, L. J. (1989). *School culture, motivation, and achievement*. Greenwich, CT: JAI Press.

- Meyer, J. P. , & Allen, N. J. (1990). The measurement and antecedents of affective, continuance and normative commitment to the organization. *Journal of Occupational Psychology*, 63 (1), 1-18.
- Marimuthu, T. (1990). *Pengenalan sosiologi Pendidikan*. Kuala Lumpur: Fajar Bakti.
- Mintzberg, H. (1989). *Mintzberg on management*. New York: Free Press.
- Najeemah M. Y (2012). School climate and teachers ' commitment : A case study of Malaysia. *International Journal of Economics Business and Management Studies*, 1 (2), 65–75.
- Nelson, D. L. , & Quick, J. B. (2002). *Understanding organizational behavior: A multimedia approach*. Cincinnati: South-Western.
- Ng, Y. M. (2006). *Principal leadership styles and management behaviour in two ethnic-cultural settings in Malaysia: A comparative case study*. Tesis Doktor Falsafah. Universiti Sains Malaysia, Minden.
- Nir, A. E. (2002). School-base management and its effect on teacher commitment. *International Journal of Leadership in Education*, 5 (4), 323-341.
- Ouchi, W. G. (1981). *Theory Z: How American business can meet the Japanese challenge*. Reading, Mass: Addison-Wesley Publishing Company.
- Paine, L. , & Ma, L. P. (1993). Teachers working together: a dialogue on organizational and cultural perspectives of Chinese teachers. *International Journal of Educational Research*, 19 (8), 675–697.
- Pang, N. S. K. (2006). The organizational values of Gimnaziala in Slovenia. *Education Management Administration & Leadership*, 34 (3), 319-343
- Pelan Induk Pembangunan Pendidikan 2006-2010. (2006). Retrieved from [http://www.smksqpusu.net/bahan/2007\\_plan\\_induk\\_1\\_5.pdf](http://www.smksqpusu.net/bahan/2007_plan_induk_1_5.pdf)
- Pelan Pembangunan Pendidikan 2013-2025. (2012). Retrieved from <http://www.moe.gov.my/userfiles/file/PPP/Preliminary-Blueprint-BM.pdf>
- Peter, L. , & John C. (2004). The effect of organisational culture and leadership style on job satisfaction and organisational commitment. *Journal of Management Development*, 23 (4), 321-338.
- Peters, T. , & Waterman, R. (1982). *In search of excellence*. London: Harper and Row.
- Peterson, K. D. (2002). Positive or negative? *Journal of Staff Development*, 23 (3), 10-15.
- Prosser, J. (1999). The evolution of school culture research. In J. Prosser (Ed. ), *School culture*, 1–14. London: Paul Chapman.
- Reza, S. , Jafar, R. S. , Mohammad, N. , Hasan, A. , & Shahrookh, K. (2013). The relation of organizational climate and job motivation with organizational commitment of new employed teachers of physical education of educations and training administration in Kermanshah Province. *Advances in Environmental Biology*, 7 (13), 4084-4088
- Robbins, S. P. , & Coulter, M. (2003). *Management (7th ed. )*. New Jersey: Prentice Hall.
- Sergiovanni, T. J. (2000). *The lifeworld of leadership*. San Francisco, CA: Jossey-Bass
- Sharifah, M. N. (2000). *Keberkesanan sekolah satu perspektif sosiologi*. Kuala Lumpur: Universiti Putra Malaysia.
- Schein, E. H. (1990). Organizational culture. *American Psychologist*, 4 (2), 109-119.
- Schein, E. H. (2004). *Organizational culture and leadership*. San Francisco: Jossey-Bass.
- Shore, L. M. , & Wayne, S. J. (1993). Commitment and employee behavior: Comparison of affective commitment and continuance commitment with perceived organizational support. *Journal of Applied Psychology*, 28, 774-780.

- 
- Tsui, K. T. , & Cheng, Y. C. (1999). School organisational health and teacher commitment: a contingency study with multi-level analysis. *Educational Research and Evaluation*, 5 (3), 249-268.
- VanderStoep, S. , Anderman, E. M. , & Midgley, C. (1994). The relationship among principal "venturesomeness" a stress on excellence and the personal engagement of teachers and students. *School Effectiveness and School Improvement: An International Journal of Research, Policy and Practice*, 5 (3), 254-271.
- Wan Mohd. Zahid. (1993). *Wawasan pendidikan, agenda pengisian*. Kuala Lumpur: Nurin Enterprise.
- Wang, H. K. C. , & Hwang, F. C. (2007). Study on organizational culture, organizational commitment and attitude toward organizational reform—comprehensive high schools as example. *The Journal of Human Resource and Adult Learning*, 3 (2), 189-198.
- Yaakob, D. (2007). *Budaya sekolah rendah: hubungannya dengan kepemimpinan, komitmen organisasi dan pencapaian akademik*. Tesis Doktor Falsafah. Universiti Sains Malaysia, Minden.
- Yukl, G. A. (2002). *Leadership in organizations* (5th ed. ). Englewood Cliffs, NJ: Prentice Hall.
- Zhu, C. , Devos, G. , & Fei, L. Y. (2011). Teacher perceptions of school culture and their organizational commitment and well-being in a Chinese school. *Asia Pacific Education Review*, 12, 319–328.

---

## The Role of Quality Management Practices in Improving the Efficiency and Effectiveness of Financial Services

Lura Rexhepi Mahmutaj

Faculty of Economics, University of Prishtina

“Hasan Prishtina,” [lura\\_rexhepi@hotmail.com](mailto:lura_rexhepi@hotmail.com); [lura\\_rexhepi@uni-pr.edu](mailto:lura_rexhepi@uni-pr.edu)

Gent Jusufi

Ph. D. student at Faculty of Economics and Management

Czech University of Life Science, [gentjusufi@gmail.com](mailto:gentjusufi@gmail.com)

Kujtim Zylfijaj

Department of Economy, Dardania University, [zkujtim@gmail.com](mailto:zkujtim@gmail.com)

Arta Koka Grubi

Department of Economy, Dardania University, [artakoka@gmail.com](mailto:artakoka@gmail.com)

### Abstract

**Purpose** – The purpose of this paper is to present a review of literature on the evolution and applicability of quality management practices in financial service organizations and key findings from secondary research in their efficiency and effectiveness. **Design/Methodology/Approach** – This paper presents some of the critical success factors and challenges that financial service faced by adopting quality initiatives. Also, it addresses benefits of Lean, TQM and Six Sigma which have improved performance in different organizations, by cutting costs and waste, as well as improving customer satisfaction. **Findings** – The result of this paper illustrates that most of the financial service organizations have adopted one or more of the quality initiatives in order to remain competitive. Some of them have faced difficulties during the implementation, because of the obstacles within organizations, which are more resistant to change compared to manufacturing ones. **Originality/Value** – This paper will have significant value to the financial service organizations and research community.

**Keywords** – Financial services, Quality practices, Six Sigma, Lean, TQM, BPR, Critical success factors, Challenges, Benefits

### Introduction

The importance of quality management practices has increased lately in financial service organizations. They are trying to adopt quality initiatives, such as Lean, Six Sigma, TQM and others in order to flatten organizations, improve communication speed, reduce their costs, defects, waste, and understand what customers' value in order to meet their expectations.

The areas which this paper discusses are the evolution of quality in financial sector, its reaction to adoption of quality programs accompanied by a brief difference between manufacturing and service organizations. Then, the quality management practices are analyzed by identifying two approaches, such as the applicability of quality initiatives in general based on surveys (Wilkinson *et al.*, 1995) and Li *et al.* (2001), and specific quality initiatives used by financial service sector. After that, critical success factors combined with pitfalls are analyzed by illustrating managers' contribution toward implementation of quality initiatives, as well as employees' and customers' influence on change and shift in organizational culture. Finally, this paper is followed by Quality management programs, such as Lean, TQM and Six Sigma by showing how financial service organizations have benefited from them.

**Evolution of Quality in Financial Services (FS) - a brief discussion on differences between manufacturing and service sector**

The global financial crisis has affected many industries, especially financial service organizations. In order to be competitive and remain in the market, financial service organizations are trying to adapt to the management changes and the complexity by implementing different quality initiatives to offer products and services with zero defects. Knights and McCabe (1997) state that in 1980s, competition was increased by having new entries in the market. In banking services, many customers were not satisfied with interest rates, so they changed the banks, or had second banking accounts. Longo and Cox (1997) pointed out that banks took in consideration their complaints, but the problem was that they were not doing things right initially. Because of new technology, high competition and high quality expectations of customers, companies needed to differentiate themselves by implementing quality initiatives. According to Knights and McCabe (1997), companies began to apply different quality initiatives, such as customer care, total quality management (TQM), business process re-engineering (BPR), team building, quality circles and others.

Companies adopted one of these quality initiatives, but the most challenges they face were associated with changes of existing organization's culture and management styles (Knights and McCabe, 1997). Also, resistance to change in middle management was a problem for implementation of quality programs (Wilkinson *et al.*, 1995). This showed that it takes time to enforce strategic change in organizational culture, because managers were using traditional way, and they were not willing to give power to employees and consider their suggestions (Knights and McCabe, 1997). According to Longo and Cox (1997), organizations should be more flexible and challenge the status quo practices in order to have transformation of culture that fit to the vision. Cultural change doesn't involve only new norms and procedures, but also exchanging values and motivating employees to change their behaviors with new practices in place.

By adopting quality initiatives, most of the companies increased awareness of the importance of quality, which increased satisfaction of customers and developed communication within a company. Still, it is hard for them to measure the benefits of quality (Wilkinson *et al.*, 1995). The majority of companies didn't have an increase in profitability (Knights and McCabe, 1997). Also, Wilkinson *et al.* (1995) claimed that quality is expensive for companies usually in the beginning when they adopted one of the quality initiatives by hiring consultants.

The service and manufacturing companies are different in number of ways. According to Troy and Schein (1995), the main difference between them is that service companies are fully concentrated in customer service, while manufacturing companies are concentrated on productivity. Service sector takes in consideration employees' views by different surveys and is likely to give recognition to them more than manufacturing companies. Also, Longo and Cox (1997) pointed out that there is a stronger relationship between managers and employees in financial service organizations comparing to manufacturing companies. However, the degree of the control of quality in manufacturing sector is higher than in financial sector because they control products before delivering to customers, while financial sector cannot control quality before having access with customers by providing service to them. Indeed, most of the organizations in financial services are enforced to implement quality initiatives. Top management should know the way to transmit changes that fit to customers' needs and wants, as well as employees' satisfaction.

### **Quality Management Practices in Financial Services – a review of literature**

In the literature, it is possible to find many studies about quality management practices in the financial services sector. These studies have been developed in two different approaches. The first approach is based on surveys related to the general application of quality management programs in the largest financial companies within different countries. For example, Wilkinson *et al.* (1996) explore different quality initiatives in 96 of the UK largest financial services companies and also, Li *et al.* (2001) reports the results obtained in the Hong Kong's banking between 1997 and 2000. The second approach is related to the application of different quality management programs in specific cases as TQM, BPR and Six Sigma. In the next paragraphs these two approaches are outlined and some examples are used to support the understanding of the role of the quality management programs in financial services.

The first approach of the quality management practices in financial services consists of an analysis of the general applications of these initiatives. According to Wilkinson *et al.* (1996) the quality initiatives have permeated the financial sector; 91% of the organizations in their survey reported that they had implemented one or more quality initiatives. It was found that some companies use different initiatives according to different objectives. That is the case of BPR which is used to reduce costs, TQM has been seen as a holistic approach, culture change is related to the employees, and customer care

and service quality are used to look at the customers. Other finding is that only the 12% of the surveyed financial organizations have perceived the implementation of quality initiatives as successful.

Li *et al.* (2001) applied the study done by Wilkinson *et al.* (1996) in the Hong Kong's banking industry. They found that "while UK institutions focus more on meeting customers' needs and wants, HK banks tend to devote more effort to meeting service standards and providing prompt services" (Li *et al.*, 2001: 516). According to the success in the implementation of these initiatives only 7% said that they were very successful. At the end, it was concluded that a bank with a small size should avoid the BPR and use the incremental change strategy, while a bank with a large size should keep no more than two programs launching simultaneously.

The second approach is related to the implementation of different programs as TQM, BPR and Six Sigma in financial organizations.

*BPR*: Drew (1996) realized a survey about the implementation of BPR to 228 senior executives in key financial centers across North America. It was found that the most important criteria for choosing BPR projects are major customer service upgrade and cost savings. BPR projects in financial service firms achieved considerable improvements in cost savings (more than 50%), but often they were implemented in short time scales.

*TQM*: Longo and Cox (1997), Longo (1994) examines different aspects of the TQM implementation in UK and Brazil. The main conclusion of this study is that TQM is at a more advanced stage in UK than in Brazil, but the Brazilian managers are more optimistic than UK managers. Other survey about implementation of TQM in financial services industry was applied again by Longo & Cox (2000) to the UK Northeast financial organizations. The main findings of this survey were that the major reasons for applying TQM are the competitive pressures, customer demand for quality and desire to reduce cost. Also, it was suggested that there is a positive link between quality, profitability, cost effectiveness and team work, even though there was evidence that "TQM is ineffective in reducing labor turnover or absenteeism" (Longo and Cox, 2000: 22). Llorens and Verdu (2004) analyze the relationship between the number of years that the firms have implemented TQM and the impact of their performance. It was concluded that "TQM produces improvement in the performance of the financial companies that implement it" (Llorens and Verdu, 2004: 116) and also, the pioneer companies in TQM have better results than other companies which take more time to implement it.

*Six Sigma*: Antony (2006) illustrates different applications of Six Sigma in financial organizations as the study done by Rucker (2000) in Citibank with significant reduction in the callbacks number, credit processing time, the cycle time between the order by the customer and the service, and statement processing cycle time. Other case is JP Morgan, which reduced "flaws in its customer-facing processes such as account opening, payment handling and cheque-book ordering" (Antony, 2006: 237). Jacobsen (2008) illustrates an application of Six Sigma in Latin-America in one of the world's largest lenders with significant advances in response time for initial credit decisions. Cox and Bossert (2005) analyze the case of the implementation of Six Sigma in the Bank of America showing results as the drop of defects across electronic channels, decreased errors in all customers' delivery channels and segments, as well as increase of new checking accounts.

In general, the success of quality programs depends of specific characteristics of each organization such as size, culture, employees, customers, region, time and objectives. Some of the programs are more effective in specific goals, and others are used as a holistic solution. It is a common practice to use two or more programs at the same time depending of the objectives of the organizations. These programs have shown effectiveness in the operation but they haven't been successful in the human aspect.

### **The critical success factors (CSFs) and pitfalls/challenges in implementing QM programs in FS**

The research of any quality improvement program comprises the issue of what are the success and failure factors for implementation. The literature provides a number of factors which contribute to the successful application of these initiatives, also, it outlines the challenges that are inherent for financial service organizations. The analysis of critical success factors defines the key ingredients for managers to contribute to the development process to enhance their chances for success.

Due to the recent unprecedented recession and fierce rivalry, identification of vital factors of successful implementation of quality management programs in financial service organizations has become much more important. As Henk de Koning *et al.* (2008) state reducing operational inefficiencies in financial organizations are of a great importance, because they comprise more than 20% of the total banking sector costs. Many banks and other financial service organizations are more than ever before interested in reducing these costs via adopting formalized quality management techniques and tools. Considering the critical success indicators for adopting these initiatives are essential for these organizations. According to Ayoob *et al.* (2003), Drew (1996), who summarized critical success factors identified by quality management gurus, and also Laszlo (1999), Antony and Bonuelas (2002), Antony *et al.* (2007), some of the most important factors can be represented as following (see figure 1).

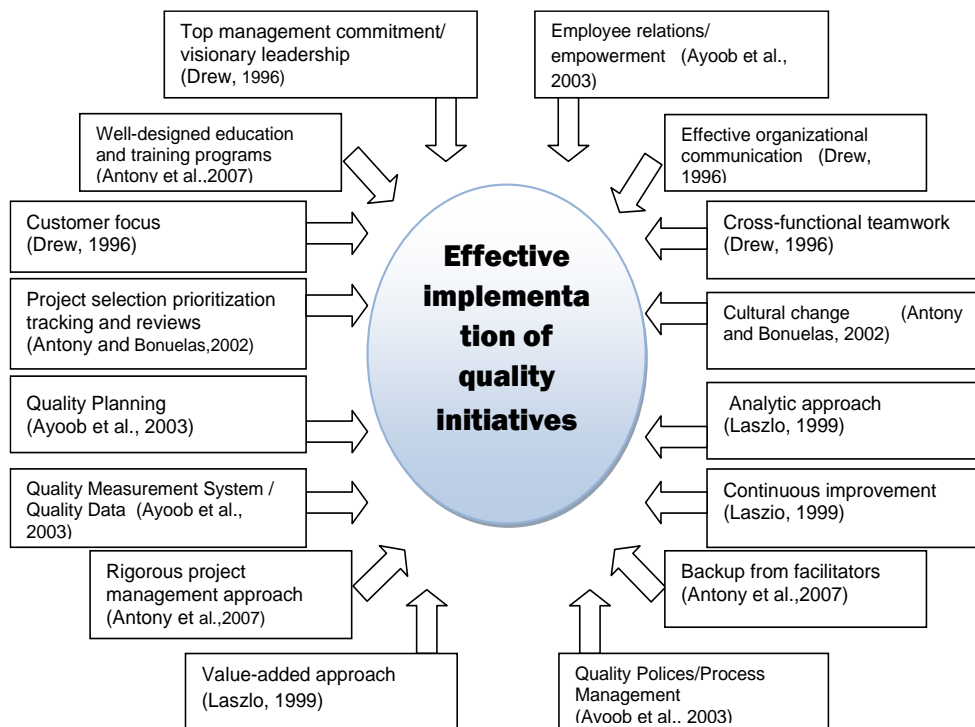


Figure 1 CSF in QM programs in FS Industry

Among these number of critical success factors, some of the most important factors were discussed in the literature especially from the perspective of financial service organizations. For example, according to Longo and Cox (2000), the results of the questionnaires sent to the managers of branches and the back-office of the biggest clearing banks and building societies in the Northeast of England identified top management commitment to be the most important quality initiative driver. Also, the survey held in Hong Kong's banking industry proved the top management commitment (75%) to be the main CSF for implementing quality initiatives. The other essential factor was employee involvement (69%) (Li *et al.*, 2001). As Newman (2001) stated on behalf of Albrecht and Zemke (1985), Schneider and Bowen (1995), Johnson (1996), Zeithaml *et al.* (1990), the employees play the most significant role in service delivery process and the quality of provision of services to external customers are significantly influenced by them. Krishnan (1999) emphasized the customer focus which ensures customer loyalty and long-term profitability for financial organizations.



Extensive literature review points that implementing quality management programs in FS organizations faces more hurdles compared to manufacturing firms. As Huq (2005) stated, greater concern and concentration on internal performance features cannot be easily aligned with the permanent transformation of customer needs and preferences. Service organizations cannot protect themselves from the erratic and irrational demands of the customers and conceal the operations from them because of the specific marketplace options.

A wide discussion of obstacles and challenges faced by these companies in the processes of deployment of various quality management initiatives comes up with a large list of them. The table 1 summarizes some of the important challenges mentioned by different authors as Gijo and Rao (2005), Larsen and Myers (1999), Antony *et al.* (2005) and Drew (1996) in accordance with the relative importance identified for each specific initiative.

Table 2 Challenges in QM in FS Industry

<b>Challenges</b>	<b>TQM</b>	<b>Six Sigma</b>	<b>BPR</b>	<b>Lean</b>
<i>Lack of Constancy of Purpose</i> (Gijo and Rao, 2005)	✓	✓	✓	✓
<i>Several initiatives at a time</i> (Li et al., 2001)	✓	✓	✓	✓
<i>Lack of in-depth knowledge of all the tools and techniques</i> (Drew, 1996)	✓	✓	✓	✓
<i>Improper Project Selection Criteria</i> (Gijo and Rao,2005)	✓	✓	✓	✓
<i>Lack of Resources</i> (Gijo and Rao, 2005)	✓	✓	✓	✓
<i>Lack of Coordination between Functions</i> (Gijo and Rao, 2005)	✓	✓	✓	✓
<i>Concentration on the Trivial Many rather than the Vital Few</i> (Gijo and Rao, 2005)	✓	✓	✓	✓
<i>Short Closure of Projects</i> (Gijo and Rao, 2005)	✓	✓	✓	✓
<i>Impatience to get Results</i> (Gijo and Rao, 2005)	✓	✓	✓	✓
<i>Accuracy and completeness of the data</i> (Antony et al., 2005)	✓	✓	✓	✓
<i>Source of the data (mostly in face-to-face interactions)</i> (Antony et al., 2005)	✓	✓	✓	✓
<i>The measurement of customer satisfaction</i> (Antony et al., 2005)	✓	✓	✓	✓
<i>Limited application of statistical tools and techniques</i> (Antony et al., 2005)	✓	✓	✓	✓
<i>Managerial resistance to change</i> (Drew, 1996)	✓	✓	✓	✓
<i>Strategic planning</i> (Larsen and Myers, 1999)	✓	✓	✓	✓
<i>Process delineation</i> (Larsen and Myers, 1999)	✓	✓	✓	✓
<i>Management support</i> (Larsen and Myers, 1999)	✓	✓	✓	✓
<i>Barriers between departments</i> (Li et al., 2001)	✓	✓	✓	✓
<i>Employee resistance to change</i> (Li et al., 2001)	✓	✓	✓	✓
<i>Economic pressures</i> (Li et al., 2001)	✓	✓	✓	✓
<i>Middle management resistance to change</i> (Li et al., 2001)	✓	✓	✓	✓
<i>Scepticism</i> (Drew, 1996)	✓	✓	✓	✓
<i>Customer resistance to change</i> (Drew, 1996)	✓	✓	✓	✓

The practical evaluation of these challenges was made in financial sectors in different countries. For example, the research of Hong-Kong's banking industry after the Asian financial crisis in 1997 and UK banking sector revealed interesting data concerning the difficulties encountered during the implementation of quality management initiatives. The major difficulties

in Hong Kong banks were barriers between departments (39%), employee resistance to change (34%) and organizational culture resistant to change (32%). In UK, the greatest hurdle which was identified is organizational culture resistant to change (65%), barriers between departments (49%), measuring quality (48%), middle management resistant to change (44%), and emphasis on short-term goal (42%) (Li *et al.*, 2001). Drew (1996) identified other factors as well, such as skepticism and customer resistance, in the USA and Canadian financial industry which hindered significantly the deployment of the initiatives there.

Concluding this section, it is worth to mention that financial service organizations have limited application of quality management practices. As opposed to manufacturing firms where the quality improvement tools techniques within an initiative are fully deployed, financial service companies face more challenges to implement them. The presence of CSFs in these organizations is constrained due to specific dimensions of service sector. Nevertheless, the best practices of banks showed a realistic and deliberate approach of lessening those difficulties.

### **Benefits from the implementation of QM programs such as Lean, TQM, Six Sigma**

Many researchers have studied the benefits of the implementation of Quality Management initiatives in the Financial Services sector. These benefits differ according to the period of time and the program implemented. In this section, we outline the benefits obtained from the implementation of quality initiatives or programs such as: Lean, TQM and Six Sigma. Finally, we have some conclusions related to the differences and similarities among these initiatives.

Wilkinson *et al.* (1996) show that the most marked positive impact of the quality programs in the financial institutions in UK are the increase in quality awareness, customer satisfaction, teamwork and communication, but aspects as absenteeism and turnover are not impacted in a positive way by the quality programs. In their findings, Li *et al.* (2001) mention that the most relevant benefits from the introduction of quality initiatives in the Hong Kong's banking industry are the customer satisfaction, efficiency and quality awareness but in a lower percentage of the companies surveyed compared to the study of Wilkinson *et al.* (1996), also it was indicated that apparently these programs do not have high effects over human factors, such as employee empowerment, employee turnover and employee absenteeism. It can be induced that there are similar results according to the benefits from the introduction of quality programs in both studies but they have had better effects in the UK financial services organizations.

*Benefits in Lean:* Lean is one of the quality initiatives that organizations use to improve performance of operations by efficiency, and reducing waste and costs. Planning and controlling operations efficiently is very important, because customers' satisfaction depends on them (Slack *et al.*, 2007). There are some financial service organizations that benefited by implementing lean techniques at low cost. According to Frost (2007), lean is very useful in financial services because it focuses on just in time and quality, which reduces costs of operations. By using lean, financial services reduced activities that are not valuable to customers and used this time to focus on processes which increase value to them. Boston Consulting Group (2008) states that banks should define operation model, find ways to implement changes by analyzing current culture, performance management, structure and costs. Teams are organized to make transformation of tools for improvement of operations. Then banks should focus on continuous improvement, which means when organizations meet demand by reducing the waste, and maintaining quality (Slack *et al.*, 2007). This can be done by training specialists to transfer knowledge of lean techniques throughout the organization. For example, a bank simplified the forms for loan approval by three days, which improved quality and added value to customers (Frost, 2007). Moreover, Boston Consulting Group (2008) discovered that customer had to wait four days for loan approval, and this was transformed to immediate approval, which increased customer experience and loyalty.

Carlebach (2007) points out a retail bank in UK, Barclays, which has used principles of lean that brought huge benefits. They focus on what customers' values in order to reduce waste and increase their satisfaction. Barclays benefited from lean by using value stream because of the problem of fraudulent online transactions. Introduction of lean techniques was done to fraud management team, such as listening to customers and know their needs, analyzing the current situation and implementing techniques to eliminate waste. In the end, this change was communicated to all levels of organization. This empowered employees, and motivated them to be more productive, as part of the change process in organization. Also, customers that were victim of fraud were refunded within one day, not three days as before and customers' complaints were reduced by 75%.

*Benefits in TQM:* Longo and Cox (2000), found that the implementation of TQM in the financial services organizations have had significant benefits in the increase of quality initiatives, customer satisfaction, number of customers and the profitability of the company showing a positive relationship between quality, profitability, cost-effectiveness and teamwork; however, they also discover that there are other expected effects, such as increase of employee morale, reduction of the labor turnover and decrease of absenteeism where the TQM has been ineffective.

*Benefits in Six Sigma:* Attenello and Uzzi (2002) recommend Six Sigma as an interesting alternative to have long term improvements in the quality of the financial institutions. Thus, there were mentioned six different benefits that the financial institutions can obtain applying Six Sigma. The first benefit is the more comprehensive understanding of the customers' requirements. The second is the reduction of cost because of the prevention of errors and elimination of rework and workarounds. The third is the help to the managers to make decisions based on statistical data and hard facts and not based on perceptions. The fourth is a "better understanding of what drives customer loyalty and how to build long-term and more profitable customer relationship" (Attenello and Uzzi, 2002: 19). The fifth advantage is the fact of avoiding radical cost savings measures that can damage the employees' morale, and the last benefit is that Six Sigma helps to bridge the gap between strategy and operations because of the possibility to link the performance measures to the business goals.

Antony (2006) presents the benefits from the adoption of the Six Sigma in service oriented companies. These benefits are the following: effective management decisions, increased understanding of customer needs and expectations with a great impact on customer satisfaction and loyalty, efficient and reliable internal operations, which leads to a higher market share, improved knowledge on tools and techniques for problem solving which have a positive impact on job satisfaction for employees, reduced number of non-value added operations which leads to a faster delivery of service, reduced variability in service performance, transformation of organizational culture to a proactive thinking and the last is the improved cross-functional teamwork. Antony *et al.* (2007) report other benefits achieved from the successful implementation of Six Sigma projects in service companies, such as improved customer satisfaction, reduced defect rate in service processes, reduced variability of key service processes, improved culture, reduced process cycle time, reduced service operational costs and increased market share. In the banking industries, they find evidence of reduction of customers complains and increase of customers satisfaction in Roberts (2004), reduction of internal and external call backs and reduction in credit processing time in Rucker (2000), significant reduction in the number of returned renewal credit cards in Keim (2001), reduction of trading errors and order corrections in Stusnick (2005), and more benefits in other financial companies, such as reduction in administration costs and reduction in the wire transfer processing time to customers.

It can be concluded that, in most of the cases, the implementation of quality programs in financial service organizations has brought high benefits in customer satisfaction and loyalty, efficiency, profitability and cost reduction, but these initiatives have not had a very positive impact in factors as increase of employee morale, reduction of absenteeism and decrease of turnover. It is explained by the radical decisions that have to be taken in the implementation of some quality programs. In general, the only program which has shown good benefits in the employees' environment is Six Sigma; the reason is that this program avoids radical cost savings measures that can damage the employees' morale (Attenello and Uzzi, 2002).

## Conclusion

Even though the majority of financial service organizations have adopted quality management programs, not all of them have achieved significant growth. There are many challenges that managers have to overcome. They understand why changes are needed, and the benefits that they will get by adopting quality programs. New skills and training are needed, and managers should spread the changes toward all levels of organizations, in order to ensure that they understand new ways (George *et al.* , 2004).

The success of these quality programs depends on specific characteristics of each organization, such as size, culture, employees, customers, region, time and objectives. It is needed to consider various critical success factors such as top management commitment, employee involvement, customer focus and others to ensure the success of their implementation. Financial service companies face much more challenges to implement quality programs than manufacturing firms due to specific marketplace choices and other limitations of this sector. However the analysis of financial industries of different countries represents that the importance of the hurdles faced by them has a great variation

from one country to another. It can be also concluded that these programs have shown high benefits in the operation, profitability and customer satisfaction in financial sector but they haven't been successful in human aspects.

## References

1. Antony, J. (2006), "Six sigma for service processes", *Business Process Management Journal*, 12 (2), 234-248.
2. Antony, J. , Antony, F. J. , Kumar, M. and Rae Cho, B. (2007), "Six sigma in service organizations: benefits, challenges and difficulties, common myths, empirical observations and success". *International Journal of Quality & Reliability Management*, 24 (3), 294-311.
3. Antony, J. and Bonuelas, R. (2002). "Key ingredients for the effective implementation of Six Sigma program" *Measuring Business Excellence*, 19 (4), 20-27
4. Attenelo, D. and Uzzi, J. (2002), "Achieving Six Sigma Quality in Financial Services", *Six Sigma Forum Magazine*, 18-22.
5. Boston Consulting Group (2008). *Banking on Lean Advantage*. Retrieved from <http://www.bcg.com/documents/file15159.pdf>
6. Carlebach, E. (2007, July/August). *What does 'lean' mean to employee communicators?* Retrieved from [http://www.connectconsultinggroup.com/downloads/lean\\_communications\\_essay\\_ezri\\_carlebach\\_jecm\\_julyaug2007.pdf](http://www.connectconsultinggroup.com/downloads/lean_communications_essay_ezri_carlebach_jecm_julyaug2007.pdf)
7. Cox, D. and Bossert, J. (2005), "Driving Organic Growth at Bank Of America", *Quality Progress*, February, 23-27.
8. De Koning, H. , De Mast, J. Does, R. J. M. M and Vermaat, T. (2008), "Generic Lean Six Sigma Project Definitions in Financial Services", *Quality Management Journal*, 15 (4), 32-45
9. Drew, S. A. W. (1996), "Accelerating change: financial industry experiences with BPR", *International Journal of Bank Marketing*, 14 (6), 23-35.
10. Frost, B. (2007). *Applying a Lean Six Sigma approach can generate rapid results in Six Sigma deployments*. Retrieved from <http://www.ssqi.com/breakthroughs/whitepaper-pdfs/EB-Lean-Services-012507.pdf>
11. George, M. , Rowlands, D. , and Kastle, B. (2004) *What is Lean Six Sigma?* George Group: McGraw-Hill, pp. 84-90.
12. Gijo, E. V. and Rao, T. S. (2005), "Six Sigma Implementation – Hurdles and More Hurdles", *Total Quality Management*, 16 (6), 721-725.
13. Hug, Z. (2005), "Managing change: a barrier to TQM implementation in service industries", *Managing Service Quality*, 15 (5), 452-469.
14. Jacobsen, J. (2008), "Improved Response Time Increases Revenue for Global Lender", *The American Society of Quality*, 1-4.
15. Keim, E. (2001), "Service quality six sigma case studies", *ASQ Annual Quality Congress Proceedings*, 188-93.
16. Knights, D. and McCabe, D. (1996), "An evaluation of quality in financial services: problems and prospects", *Managing Service Quality*, 6 (1), 18-21.
17. Knights, D. and McCabe, D. (1997), "Can a leopard change its spots?- seeking quality in financial services", *Managing Service Quality*, 7 (2), 102-105.
18. Krishnana, S. , Ramaswamy, V. , Meyer, M. and Damien, P. (1999), "Customer Satisfaction for Financial Services: The Role of Products, Services, and Information Technology". *Management Science*, 45 (9), 1194-1209.
19. Larsen, M. A. and Myers, M. D. (2005), "When success turns into failure: a package-driven business process re-engineering project in the financial services industry", *Journal of Strategic Information Systems*, 8, 395-417.
20. Laszlo, G. P. (1999), "Implementing a quality management program – three Cs of success: commitment, culture, cost", *The TQM Magazine*, 11 (4), 231-237.
21. Li, E. Y. , Zhao, X. & Lee, T. (2001), "Quality management initiatives in Hong Kong's banking industry: A longitudinal study", *Total Quality Management*, 12 (4), 451-467.
22. Llores, F. J. and Verdu, A. J. (2004), "Institutional Isomorphism and Performance: The Case of Financial Services", *Total Quality Management*, 24 (5), 103-119.
23. Longo, C. R. J. and Cox, M. A. A. (1997), "Total quality management in financial services: Beyond the fashion the reality has to take off", *Total Quality Management*, 8 (6), 323-333.
24. Longo, C. R. J. and Cox, M. A. A. (2000), "Total Quality Management in the UK financial services: some findings from a survey in the northeast of England", *Total Quality Management & Business Excellence*, 11 (1), 17-23.

- 
25. Longo, C. R. J. (1994), "Quality Management: An Assessment of Situation in Finance Sector in UK and in Brazil", School of Business Management, University of New Castle.
  26. McCabe, D. and Knights, D. (2000), "The human face of re-engineering in financial services". *Managing Service Quality*, 10 (2), 74-77.
  27. Newman, K. (2001), "Interrogating SERVQUAL: a critical assessment of service quality measurement in a high street retail bank". *International Journal of Bank Marketing*, 19 (3), 126-139.
  28. Roberts, C. M. (2004), "Six sigma signals", *Credit Union Magazine*, 70 (1), 40-3.
  29. Rucker, R. (2000), "Citibank increase of customer loyalty with defect-free processes", *Journal of Quality and Participation*, 32-6.
  30. Slack, N. , Chambers, S. , and Johnston, R. (2007) *Operations Management* pp464-474. Edinburgh Gate, Harlow, Essex: Pearson Education Limited.
  31. Stusnick, D. (2005), "Back to the future", *Quality World Magazine*, 19-23.
  32. Troy, K. and Schein, L. (1995), "The quality culture: manufacturing versus services", *Managing Service Quality*, 5 (3), 45-47.
  33. Wali, A. A. , Deshmukh, S. G. and Gupta A. D. (2003), "Critical success factors of TQM: a select study of Indian organizations", *Production Planning & Control*, 14 (1), 3-14.
  34. Wilkinson, A. , McCabe, D. & Knights, D. (1996), "Looking for quality: a survey of quality initiatives in the financial services sector", *Total Quality Management*, 7 (1), 67-78.
  35. Wilkinson, A. , McCabe, D. and Knights, D. (1995), "What is happening in quality in the financial services?", *The TQM Magazine*, 7 (4), 9-12.

---

## Information Literacy Primary School Students in the Czech Republic in International Comparison

**PaedDr. Zuzana Horváthová, Ph. D.**

Department of Law and Public Administration, Metropolitan University Prague  
zuzana.horvathova@mup.cz

**Assoc. Prof. Ing. Josef Abrhám, Ph. D.**

Department of Law and Public Administration, Metropolitan University Prague  
josef.abrham@mup.cz

### Abstract

*Increasing amount of information available becomes a reality of the contemporary global world. However, proper and effective use of information depends on a set of information management skills. Recently, information literacy has become one of the key elements of the educational process at a primary, secondary and tertiary level. The aim of this paper is to evaluate the ability of primary school students to manage information. The main part of the research output is delivered via own survey, which focuses on final-year students of primary schools in the Czech Republic. Information sources, ability to select them and to make decision or trustworthiness check belong among those primarily examined. Also an access to new information and decision-making ability of students in selection process and use of information is analysed. The results of the survey are compared with those provided by academic literature and by other international research in this field.*

**Keywords:** information literacy, basic education, Czech Republic, informatics and communication technology

### 1. Introduction

Information literacy has become an important prerequisite for successful processing in almost all fields of the current economy and society. The amount of available information continues to grow and increases the demand for the quality of its processing and handling. Thus information literacy has recently become in one of the essential parts of the educational process. Working with information in the educational process embodies itself in several ways. This is namely the ability of students to understand the text (literacy), skills in information and communication technologies including the internet and also the quality of the selection, classification and verification of information sources. Information skills are therefore subject to numerous research articles, various comparative studies at the international level as well as subject to methodologically oriented papers, which seeks to develop methods for measuring information literacy. This study represents a further contribution to the debate in the field.

The aim of this paper is to evaluate the ability of primary school students to manage information. The main part of the research output is delivered via own survey, which focuses on final-year students of primary schools in the Czech Republic. Information sources, ability to select them and to make decision or trustworthiness check belong among those primarily examined. Also an access to new information and decision-making ability of students in selection process and use of information is analysed. The results of the survey are compared with those provided by academic literature and by other international research in this field. The literature review also includes an overview of several methodological concepts of measurement information skills of students in primary and secondary schools, which were applied in the Czech Republic and the European Union.

## 2. Theoretical approaches to education and literacy in the contemporary information society

The increase in the importance of information literacy within the contemporary education and society is reflected in the academic papers that are covered in the following text. The emphasis is placed both on the assessment of the significance of information literacy in the works of theorists in the education field and also the different approaches to monitoring and evaluation of the information literacy.

On the basis of a research focusing on education and training in the information society, Dombrovská, Landová, Beneš and Rambousek came to the conclusion that although the educational potential of information technology opens up new possibilities for education in the information society, the approach of schools to the education has to be changed. If not, information technologies will not be a positive factor and will not make educational process more efficient, but rather they will only become a tool for upgrading the educational process, without its educational use in practice and continuing education (Beneš, Rambousek, 2005). The goal of modern education is a functional literacy and not the content of knowledge, as was the case in the past, which means interpretation and processing of not only statistical data (Dombrovská and Landová, 2004).

Fialová builds on the results of national research focused on students' opinions on the implementation of information technologies in education, where it was concluded that although information technology cannot replace the social interactions in the class and in the direct learning process, still with an appropriate use of computers (e. g. for a teamwork) pupils learn to work in a team and act as a single entity and thus the social conscience of individuals improves (Fialová, 2005).

Filipi defines information literacy as the ability to recognize the needs for information, the knowledge to find and use it effectively. He perceives this ability as a summary of skills to work with the most used software and internet use not only for communication but also for searching for and processing of information. ICT skills are seen as a unification and application of cognitive and technical skills and consist of five basic components, namely (Filipi, 2012, p. 11):

- Access: knowledge of gathering and getting the information via ICT;
- Manage: use of existing classification and organization scheme;
- Integrate: representation and interpretation of information via ICT;
- Evaluate: decision about relevance, usefulness, quality and efficiency of information;
- Create: creation of new own information, possibly using amendments and adjustments of the existing information via ICT.

Brdlička addressed the issue of integration of information education into curricula at primary and secondary schools. He understands the information education as a preparation for life in the information society where tutoring should not focus only on the computer but also on how to make appropriate use of this ability (Brdlička, 1998).

The trend in our modern society is using the internet, via computers one can easily and affordably communicate over long distances, seek information from diverse regions and sectors, to educate themselves, find jobs, work and shop. To make internet a benefit for individuals and not just a conduit for communication and spending leisure time by surfing or playing computer games, the pretty computer literacy is needed. In modern education the stress is put on children education in this area and from primary school these skills are taught. Adults are treated pretty same in this area as there is a necessity to have mastered at least basic skills related to the PC and ICT. The main reason is the competitiveness of individuals in the labour market, nowadays it is quite common that the given literacy is one of the requirements that are imposed on jobseekers by employers. The previous text shows that computer literacy is, together with functional literacy a part of the information literacy. An individual, who is not computer literate or functionally literate, can not necessarily be information literate. The relevant skills are necessary for current and future application and adaptation in the contemporary anamorphic society.

Mudrák considers the information education for a more cross-cutting discipline in many areas of education. That makes the discipline alone richer in terms of the content, ideology and also methodology, but at the same times that raises new questions and challenges to be addressed (e. g. the use of information technology in teaching physics, languages, mathematics and music). The concepts and relationships that show some stability in the dynamic environment of the

information society must predominantly become the content of educational training. Finally, the didactics of information education should respect the cross-curricular nature (Mudrak, 2005).

In recent years, a number of projects have been implemented in the area of information literacy. They map literacy and work with information technologies in international comparison. One example of those studies is a study called the International Computer and Information Literacy Study, where the students of the 8th grade of the elementary schools and the students of the grammar schools at the corresponding grade are tested. The project focuses on the implementation of international research and the subsequent use of results in educational policy and their own teaching practice at schools in the country. In 2013, the undertaken research was aimed at detecting differences in computer and information literacy of students in the surveyed countries, at verifying the relationship between the success of students and educational systems setting, at the effect of technological background of the students on their success in computer and information literacy as well as at the effects of socio-economic background of students on their results in computer and information literacy (Fraillon, 2013).

Another example of a widespread concept in the area of computer literacy and skills is a so called European Computer Driving Licence (ECDL), which includes a wide range of training and certification programs. ECDL is internationally recognized certificate of computer literacy. The contents of the tests are based on the ECDL syllabus. They are subject to scrutiny of the sole proprietor of the ECDL concept and of the testing methodology, which is a non-profit organization called Council of European Professional Informatics Societies (CEPIS). ECDL concept focuses on the labour market. The attention is paid to the successful and effective use of digital technologies (Neumajer, 2012).

A highly respected international comparative study is regularly published by OECD, so called PISA testing. This project focuses on mathematics, science and reading but also digital skills. From 2015, the testing in all areas surveyed runs electronically. As the most important skill of electronic reading is considered the orientation on sites which means quick browsing of the structure on non-linearly arranged websites. The students who did better managed to do so because they used a better strategy such as minimizing the visits of the irrelevant sites and vice versa finding quickly the requested ones. Test mechanisms in the PISA study simulate real situations. A student has the opportunity to work with simulations of a simple web-browser, which can be accessed on the pre-web addresses, pages and entire sites (Neumajer, 2012).

In the Czech Republic there has been recently undertaken a survey under the GAPARD programme, which focuses strongly in the area of working with information, it means on "information literacy" as such, and that applies to students already in elementary schools and then applies throughout the whole life. A technical use of ICT as a tool is somewhat less important than its meaning: work with information, their acquisition, processing and transmission to others. At the top of such prepared sites there is a set of tasks, through which a student goes in the course of testing. There are several types of tasks. Most often it is about solving a closed task, which has four alternatives and in order to determine the correct response, finding the relevant information on the website is needed. This website has usually set a few pages linked with references. In other tasks there are open questions that require answers creation. An example of this task is to send an e-mail through a web form. Everything is still ongoing in a simulated environment of the internet browser. The content of the e-mail should be a summary of information that can be found on the prepared site (Neumajer, 2012).

### 3. The research of information skills of students in the Czech Republic

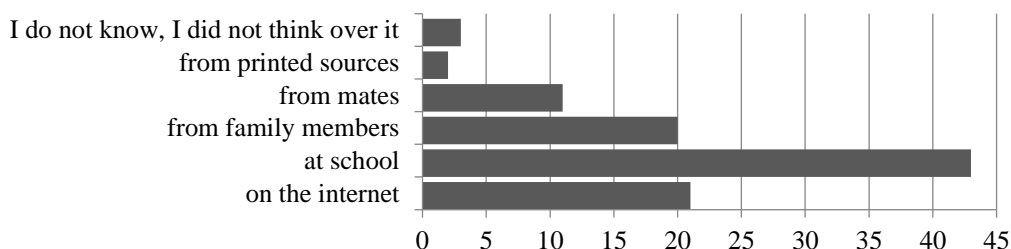
The research is based on survey that focuses on identifying sources where fifteen year-old students of the Czech schools get their information. The emphasis is also placed on the ways of verifying the information and factors that influence the decision making of the students. The questionnaire was designed as a dialogue between the interviewer and the respondent. The questions were ordered from simple to more complex ones. They were closed with a choice of either one answers or marking on the range of options from a completely positive response to a negative one. Almost all the issues have been given the opportunity to answer "I do not know / I did not think about it." The questionnaire was anonymous and the entire research was compiled on a sample of 470 respondents. The respondents were fifteen year-old students of secondary schools, grammar schools and apprenticeships from Prague and from the cities in the Central Bohemia. The questionnaire survey was carried out in the period from May to September 2014.

Based on the results of the survey seven answers to seven concrete questions will be discussed in the following text. These issues included the findings in the area of information sources, the information confrontation with the present level of



knowledge, the assessment of decision-making skills of the students and the verification of the quality and relevance of the information.

**Graph 1: Responses to the question „Where do you get most of your knowledge“**

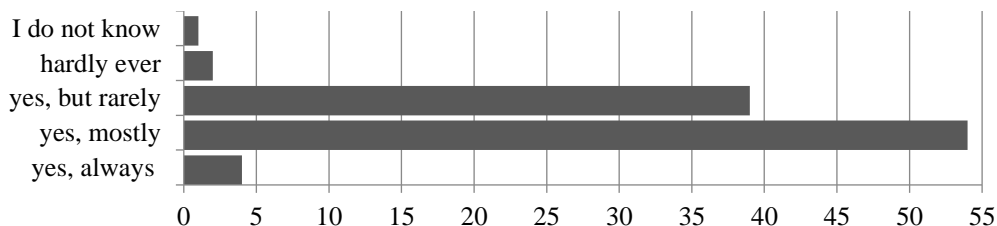


**Source: Own survey made in 2014**

From Graph 1, which illustrates the responses to a question about sources of information, it is clear that most information students receive at school, followed by the options „from family members“ and „on the internet“ which took almost the same position. In a much lesser extent students receive information from friends. The frequency of other offered options is negligible. Nearly half of the respondents use the educational process within the school as the main source of information. In contrast, almost a quarter of students stated that they obtained the knowledge on the internet and from individual family members. It can be therefore concluded that fewer than half of the students complete the compulsory education with the feeling that most of the knowledge provided to them was at school.

As for the second question, if they can confront the findings with their knowledge, the majority of respondents answered yes (Graph 2). The question was posed in order to investigate own opinion of the students on their ability to compare information and knowledge. The vast majority of students (97%) think that they have this ability, however with varying degrees of intensity. The answer "hardly ever/never" was chosen only by 2% of students. The frequency of the response "I do not know" is only 1% and thus indicates a group of students who do not think over the information and knowledge. It can therefore be noted that the vast majority of students believe that they are able to process and compare the information obtained. On the other hand, it should be noted that such a positive response may be questionable, and it would be reasonable to complete the given survey with testing of the answers obtained.

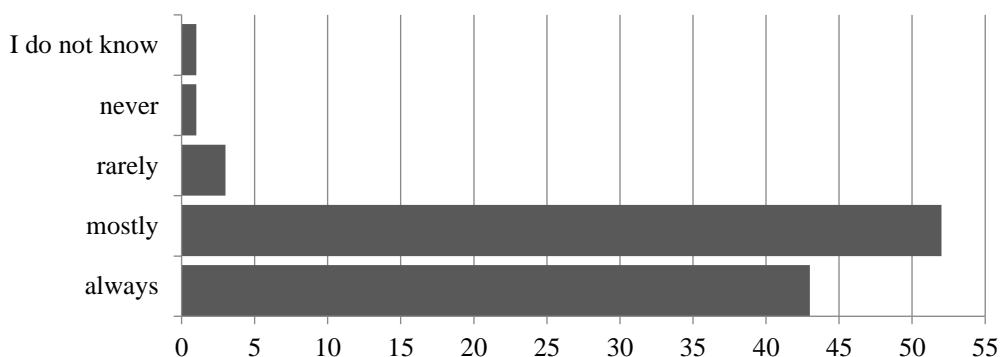
**Graph 2: Responses to the question „Are you able to confront the information with your existing knowledge?“**



**Source: Own survey made in 2014**

Graph 3 shows the frequencies of the response to the question whether the respondents are aware of the need for their independent decision-making when working with information. Depending on their self-reflection based on their age, the students mostly answered positively. The vast majority of respondents (95%) recognize the importance of decision-making, either „always“ or „mostly“ (more than 50% of responses). The question was included in the survey on purpose as the conditions of the contemporary society place increasing demands on decision-making abilities of pupils and students (e. g. when choosing the next stage of education, study abroad, future occupation, etc. ).

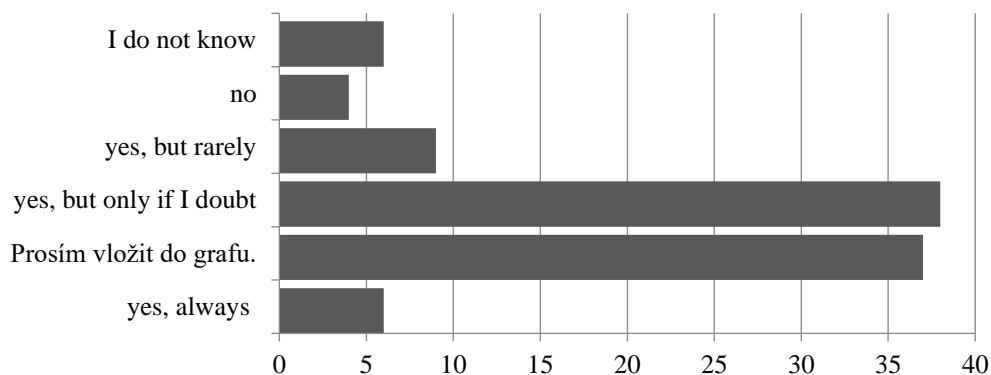
**Graph 3: Responses to the question „Are you aware of the need of own decision-making when working with the information? “**



Source: Own survey made in 2014

In another area of the research, which involved the verification of the information obtained, the respondents were generally positive. Almost 90% of those surveyed verify the quality of information, especially when they have some doubts. Furthermore, the verification is also abundant in terms of knowledge which is exceptionally interesting. The negative range of responses is almost negligible. The question was asked as to determine whether and what information the students verify. The scale of answers offered was closed with a range from extremely positive to completely negative.

**Graph 4: Responses to the question „Do you verify the information obtained? “**



**Source: Own survey made in 2014**

Another question further elaborated the way of verifying information. Table 1 presents a simplified matrix in which we can read how (in what sources) and how often students verify the information. From Table 1 we can observe that the most preferred source is the internet. Also the trust in the family and in case of half of the students the trust in the school is positive. The role of other sources offered is entirely negligible. The questions included a closed range of answers indicating the frequency on the scale of the options from totally positive to the negative ones. There was also an option „I do not know“ offered as the emergency one.

**Table 1: Responses to the question „How often do students verify the information in the following sources?“**

	Often	Sometimes	Seldom	Not at all	I do not know
At school	10 %	40 %	35 %	5 %	10 %
At home	40 %	42 %	13 %	3 %	2 %
On the internet (from one source)	42 %	37 %	17 %	3 %	1 %
On the internet (from more sources)	44 %	39 %	11 %	1 %	5 %
Combining more sources	12 %	28 %	33 %	16 %	11 %
In daily press	2 %	17 %	21 %	50 %	10 %
In books	6 %	15 %	32 %	38 %	9 %

**Source: Own survey made in 2014**

The last question of the questionnaire survey stems out from the hypothesis that the young man can be very easily influenced by the mass media, classmates and friends. A closed offer of the answers was compiled from the anticipated potential factors on the respondents at their age. Each answer offered contained a scale of the importance of the factors ranging from completely positive to completely negative. The answer „I do not know“ was inserted as an emergency one, however, the frequency of that one was very low and thus not conclusive. The responses clearly showed that the major factors influencing students' decision-making are at first the benefit for a given student and then the information obtained. Another important factor is the view of the family, followed by the recommendation of teachers at school. The opinion of the friends and decision-making of the majority have only a partial effect. An actual mood has only a marginal effect.

**Table 2: Responses to the question „Are students at this age influenced in their decision-making mainly by media and friends?“**

	Very important	Quite important	Not much important	Not important at all	I do not know
TV, radio	6 %	39 %	33 %	15 %	7 %

Opinion of friends	13 %	44 %	38 %	4 %	1 %
Opinion of majority	12 %	37 %	43 %	5 %	3 %
Recommendation of parents	32 %	45 %	19 %	3 %	1 %
Recommendation of teachers	27 %	46 %	23 %	2 %	2 %
Actual mood	14 %	12 %	25 %	45 %	4 %
Personal benefit	64 %	29 %	4 %	1 %	2 %

Source: Own survey made in 2014

The last question in the questionnaire featured the verification of the credibility of electronic information sources. It was assumed that the students consider the main sources of information those electronic ones. Internet sources are not only used to search for information, but also for self-education or spending leisure time by today's young generation (Table 3).

**Table 3: Responses to the question „To what extent do the students trust the information sources? “**

	Very credible	Quite credible	Not credible much	Not credible at all	I do not know
According to first offered sites by Google (or another viewer)	16 %	53 %	23 %	5 %	3 %
Wikipedia	33 %	44 %	18 %	4 %	1 %
Professional databases	46 %	29 %	1 %	1 %	23 %
Academic websites	39 %	25 %	11 %	4 %	21 %
Professional firms' websites	26 %	34 %	10 %	8 %	22 %

Source: Own survey made in 2014

The range of answers was once again closed and divided into a scale of two positive and two negative responses. The answer "I do not know" was re-launched as an emergency one. Since the aim of the question is to identify the views of respondents, the answer „I do not know" can be considered "I do not have that knowledge". The students probably do not know that source in the way that they do not use it. As "a very credible" information source were perceived technical or professional databases, followed by websites of academic institutions and professional firms. In contrast, the answer „I do not know" was the most frequent one with these sources. It can be therefore assumed that those who use these sources also trust them. However, almost a quarter of students probably do not know professional databases as a source of information, because they cannot assess their credibility. The information provided via Google and Wikipedia are considered by students predominantly as "more credible". However, with these sources, the answer „I do not know" emerged only in case of 3% of students. We can assume that students know these sources and perceive them as quite or very credible.

#### 4. Conclusion

The importance of information literacy for the educational process as well as for other professional life of the graduates is confirmed both by the theoretical concepts as well as by strategic documents at national and international level. The importance of working with information is increasing as a result of the development of modern technology and the knowledge economy.

Based on the results of a questionnaire survey one can say that working with modern communication technologies and computers for students of elementary schools in the Czech Republic is quite natural. Mostly, students seek information on information portals, which are normally accessible both to users as well as to the authors who make up the content of the website etc. However, these sources are out of control in terms of truth and objectivity. If the students verify the information, they use the same sources for verification as for their acquisition. It can be assumed that they use the same internet sources in order to test their knowledge as the internet is the second most common source for obtaining knowledge right after the school.

The examined respondents used books, newspapers and magazines very marginally. The influence of the media such as television and radio is smaller than in the case of the internet. A very positive finding can be a still significant effect of family and school on obtaining and verifying information as well as on the subsequent decision-making. In this context, it seems appropriate to increase a focus of the educational process in the Czech Republic and other European Union countries on the information and communication technologies. School facilities must fully exploit the potential of new information sources and verify the ability to work with them on the side of their students. In relation to the undertaken research one may recommend the application of simulations of web browsers, testing the ability of electronic reading, the assessment of the speed of scrolling over non-linearly arranged structures of web sites, etc.

#### 5. References

- [1] BENEŠ, P. , RAMBOUSEK, V. *Výchova a vzdělávání v informační společnosti*. In *Vzdělávání pro život v informační společnosti*. Praha: Pedagogická fakulta UK. 2005. s. 11. ISBN 80-7290-202-4.
- [2] BRDLIČKA, B. *Informační výchova na ZŠ z pohledu rodičů. Výsledky výzkumu mínění* [online]. [cit. 20. 2. 2015]. Praha, 1998. Dostupné na: <<http://it.pedf.cuni.cz>>
- [3] ČAJKA, RÝSOVÁ, L. : *Úloha univerzit v regionálním rozvoji*. In: Sborník z příspěvku z Mezinárodní geografické konference v Ostravě ve dnech 30. a 31. 8. 2004 „Geografie a proměny poznání geografické reality“, Ostrava: Ostravská univerzita v Ostravě, 2004 s. 377-382, ISBN 80-7042-788-4.
- [4] ČERNOCHOVÁ, M. , SIŇOR, S. *Využití ICT ve školní praxi jako příprava na celoživotní učení v informační společnosti*. In *Vzdělávání pro život v informační společnosti*. Praha: Pedagogická fakulta UK. 2005. s. 301. ISBN 80-7290-202-4.
- [5] DOMBROVSKÁ, M. ; LANDOVÁ, H. ; TICHÁ, L. *Informační gramotnost - teorie a praxe v ČR. Národní knihovna* [online], 2004, roč. 15, č. 1, [cit. 2013-11-12]. Dostupný z WWW: <http://knihovna.nkp.cz/NKKR0401/0401007.html>.
- [6] FIALOVÁ, I. *Názory studentů k implementaci informačních a komunikačních technologií do vzdělávání*. In *Vzdělávání pro život v informační společnosti*. Praha: Pedagogická fakulta UK. 2005. s. 377, 378. ISBN 80-7290-202-4.
- [7] FILIPI, Z. *Počítačová gramotnost a její zvyšování pomocí e-learningu u úředníků*. In *Information and Communication Technology in Education*. Ostrava: University of Ostrava, 2010.
- [8] FRAILLON, J. , SCHULZ, W. , AINLEY, J. (2013). *International Computer and Information Literacy Study: Assessment framework*. Amsterdam: IEA.
- [9] HOŠŤOVECKÝ, M. , MIŠUT, M. , PRIBILOVÁ, *Web based testing in science education*. In *Lecture Notes in Electrical Engineering In Innovations and Advances in Computing, Informatics, Systems Sciences, Networking and Engineering*, 2015, Springer International Publishing, ISBN 978-3-319-06772-8, pp. 247-254.
- [10] ICILS 2013 [online] *Mezinárodní výzkum počítačové a informační gramotnosti*, 2013, [2013-11-05]. Dostupný z WWW: <http://www.icils.cz>.

- 
- [11] KLEŇHOVÁ, M. , ŠŤASTNOVÁ, P. , CIBULKOVÁ, P. České školství v mezinárodním vzdělání. Praha: Ústav pro informace ve vzdělávání. 2010. ISBN 978-80-211-0604-8.
- [12] KOCOUREK, A. , MARŠÍKOVÁ, K. Shifts in Income Expectations of Czech Students at Selected Economic Faculties over the Years 2001 - 2012. In *Ekonomický časopis*. 2013. roč. 61, č. 4, s. 358-375. ISSN 0013-3035.
- [13] MUDRÁK, D. Přístupy k rozvoji didaktiky informační výchovy. In *Vzdělávání pro život v informační společnosti*. Praha: Pedagogická fakulta UK. 2005. s. 194. ISBN 80-7290-202-4.
- [14] NEUMAJER, O. Testování ICT dovedností v ČR - vybrané projekty a koncepty. Praha: Pedagogická fakulta UK. 2012.
- [15] RUBÁČEK, F. Porovnání přístupnosti webových prezentací středních škol v České a Slovenské republice. In *Technológia vzdelávania*. 2011. ISSN 1338-1202.

---

## Generation Y – Characteristics of Attitudes on Labour Market

Dr Agnieszka Stanimir

Wroclaw University of Economics,

Komandorska 118/120, 53-345 Wroclaw, Poland

agnieszka.stanimir@ue.wroc.pl

### Abstract

*The purpose of this paper is to present possible attitudes of Gen Y on the labour market, characteristics that can be used in the management of young employees. Second purpose of this paper is to find if the assessment of present job changed during time for Generation Y. Gen Y are persons almost adults but with a less than 35 years, they were born in the 80s and 90s of the twentieth century. This period is conventional and in each country the cohorts may be different. Affiliation to the generation Y depends on the culture, lifestyle, family and friends patterns, social surrounding. Deal (2007, p. 14) writes that all generations have similar values and "they just express them differently". In Parment (2013) may be find that identity, image and social networks have become increasingly important in the job seeking process. These same characteristics that also affect the perception of conditions of work and the obligation to work. Gen Y do not want to work as hard as the older generations. They don't believe that work is important part of life, but they tend to work-life balance. Because Gen Y are multitasking, so they willingness to learn new thing is stronger than in older persons. They are also ready to work hard, but only when their work is meaningful. After analysis of the ESS data, it was found that between Poles and the respondents belonging to the countries participating in the ESS there are differences in the perception of the present job, and that the attitude to work of Gen Y in 2004, was changed in 2010. The paper concludes with suggestions for the employers, how to manage Generation Y.*

**Keywords:** Generation Y, labour market, characteristics of the work and employees

### 1. Introduction

The objective of research concerns on detecting differences between four generations on labour market and analysis of changes in attitudes to work. The analysis allowed to determine the guidelines for managers of employees of Gen Y.

This article presents the results of research conducted on the Data ESS Round2 and Data ESS Round5 (ESS - European Social Survey). From the questionnaires were taken questions about assessment of current job:

- 1) Job is secure;
- 2) Job requires learning new things.

Each respondent chose one of the given response: Not at all true, a little true, quite true, very true. The analysis was conducted for the data from the years 2004 and 2010. In first period, the study group was aged 18-29 years (divided into two groups 18-24 and 25-29). Then were checked the attitudes after six years for these groups, so in 2010 the study group was aged 18-35 years. All persons from the age group 18-30 in 2010 belonged to the Generation Y, and respondents 31-35 year old belonged in 2010 to Generation X. Gender of respondents was also taken into consideration in analyses. In 2004 in survey (ESS Round2 and ESS Round5) participated respondents from 26 countries, and in 2010 from 28 countries.

Generation Y (Gen Y, Millennials, Yers) is the best educated group in the current labour market. They are the youngest, but they realize their knowledge and skills, they want to be equally, respectfully treated. Generation Y grew up with free access to modern technologies, therefore, their ability to use ICT in their everyday lives and work are much better than workers from other generations. Generation Y grew up in the age of globalised economy "surrounded by mobile phones and the Internet" (Barwińska-Malajowicz, p. 302) e-mails, e-commities. For them Internet is that place where they may find everything.

Gen Y are born in the 80s and 90s of the twentieth century. Therefore, this group includes people who are already functioning the labour market (age 25-34), those that are starting a job search (18-24) and the youngest Yers who are completing their training (14-17). The youngest group of Yers after entering the labour market will be even more surprising for the other generations, their ability to use modern technology will become more natural.

In the labour market, there are still three other generations: Traditionalists (1922-1945), Baby Boomers (1946-1964), Generation X (1965-1980). Each of these generations behaves differently in the labour market, but it should be noted that the difficulties indicated by one generation are other advantages. Bałowska (2013, p. 10) writes that " Each generation has its own occupational preferences and its own market needs". Can be identified the conventional age cohorts in each country, however, this distribution may be different. Apart from the most frequently mentioned four generations could in fact be several other groups of the population.

Traditionalists (Veterans, Silent Generation, Matures, see for ex. Parry and Urwin (2011)) traditionalists are the oldest people that currently the most frequently are no longer working, but it is still among them a group of professionally active (compare Figure 2). People of this generation are very loyal employees, a fully respect for the authority. They are very involved in their work. They are not open to changes. Thrifty and preferring cash payments, what is related to their risk aversion. They are strongly attached to respect of procedures.

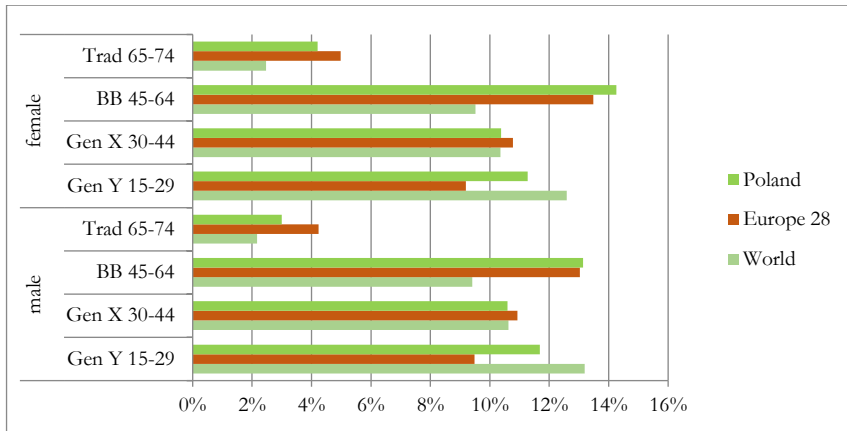
Baby Boomers (BB) are persons who were born after WWII during the demography explosion. Parment (2013) indicates that the baby boom started earlier in the US than in Germany, where the phenomenon was inhibited by the destruction and poverty after WWII. Sometimes this group is divided into two generations: Boomers I (Traditionals, born 1946-1954) and Boomers II (Generation Jones, born 1955-1965) (Schroer, 2015). They differ of their objectives, priorities, scope of use of available technology and dealing with money. However, it can be concluded that all the Baby Boomers have similar attitude to work. They are loyal and say that hard work should be associated with the position, prestige and career advancement. BB move their family away into the background when they have to fulfil their professional duties (Bałowska 2013). Greater financial opportunities and the availability of higher education degrees focused them on career. (Loretto 2015). Baby Boomers are in many cases the parents of Xers and even Yers. It Baby Boomers gave the Xers and Yers access to better living and modern technology.

Generation X is also called "Baby Busters, Twenty something, and the F-you generation" (Acar 2014, p. 12). As Ruthus (2014) explained, people from generation X are individualistic career-oriented, so they are looking for development opportunities in work, they make pragmatic and rational decisions. They appreciate family life. They have a respect for work. Although they are sceptical, they are loyal to their employer. They like to be independent. Because Xers grew up in a period intensified technological developments, their expectations of quality of life are much higher than those of previous generations. "Freedom is more important to them than money and titles" (Ruthus, 2014. p. 7). The result of the study of Gursoy et al. (2008, p. 451), which was carried out by in-depth focus, is the main characteristic of Gen X as: "Respond to instant gratification, Work to live, Identify with the lone ranger, Friends in high places".

Independently of gender, the share of Yers in the World population exceeds the share of generation X, BB and Traditionalists (Figure 1). For the population of Europe in 2010, the percentage of men and women of Gen Y is lower than the other groups that functioning in the labour market. In Poland there are more persons of Gen Y than Xers and Traditionalist.



**Fig 1:** The percentage rate of people in 5 age groups in the total population of Poland, Europe and World.

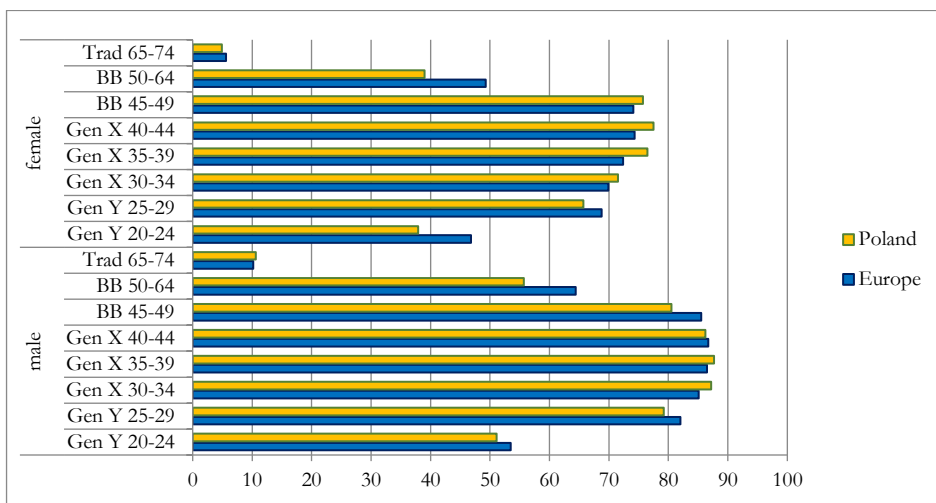


Source: own elaboration on data from OECD, EUROSTAT [demo\_pjangu].

The next graph (Figure 2) illustrates the employment rate of each generation in 2010. Because EUROSTAT data were used, the age range was adopted identical to those contained in the source table. The employment rate for women from Gen X and younger from BB was in 2010 higher in Poland than the average employment rate in the EU. The employment rate of men from generation X was slightly higher in Poland than in the EU. As shown in Figure 2 the smallest group of those working are people from Traditionalists generation. The employment rate of youngest people from Generation Y is much lower than for the other analyzed persons from Yers, Xers and BB. Among people aged 20-24, there are many people who still learning and so the ratio is low (lower for women).

The employment rate (independent of age) for people participating in the labour market is lower for women than for men (both in Poland and in the EU). As seen from Figure 1 the largest part of the population in Poland and Europe are persons of BB generation. Figure 2 shows that the employment rate of people aged 45-49 years remained at a high level, and for those aged 50-64 is decreasing significantly.

**Fig 2:** Employment rate in EU and Poland in four generations by gender



Source: own elaboration on data from EUROSTAT [lfsa\_ergan].

## 2. Characteristic of Generation Y

In the literature, can be find another term for Yers: millennium generation, next generation, i-pop generation, e-generation (Barwińska-Mojłowicz 2011). Martini (2005, p. 40) indicates that Gen Y "call themselves the Non-Nuclear Family Generation, the Nothing-Is-Sacred Generation, the Wannabees, the Feel-Good Generation, CyberKids, the Do-or-Die Generation, and the Searching-for-an-Identity Generation". These all names fully reflect the character, lifestyle and attitude to work Generation Y.

Generation Y are people who were born between 1980 and 1999. But those years are conventionally determined. However, in each country, the age cohort may be different. In the Hole, Zhang, Schwartz (2010) can be find examples of generational partitioning occurring in different countries: China, India (Gen Y: 1981+), South Korea (Gen X and Gen Y simultaneously 1970+), Japan, Russia (Gen Y 1983 -2000), South Africa (Gen Y 1990-2000), Brazil (Gen Y 1981-2001), US (Gen Y 1981-2001). Gentry et al. (2011, p. 41) define Gen Y as: "grew up in the digital age".

People belonging to this generation are get used to make permanent many choices (Parment 2013). Thus, multitasking is for them everyday life. Gursoy et al. (2008) suggest that Gen Y expects from their superiors to indicate how to proceed, which results in a lack of ability to make critical decisions.

They have a need for a constant feedback, so that Gen Y can function correctly. In the study described by Parment (2013, p. 6) is indicated that 36. 4% of respondents said that "feedback is very important for them and affects their efficiency." Another characteristic of Gen Y is that the rules are set out in order to be broken (Gursoy et al. 2008). Millennials are a generation without "territorial limitations in communications" (Barwińska-Małałowicz 2011, p. 303). This is due to the fact that from birth they have access to new technologies that they use better than a Generation X.

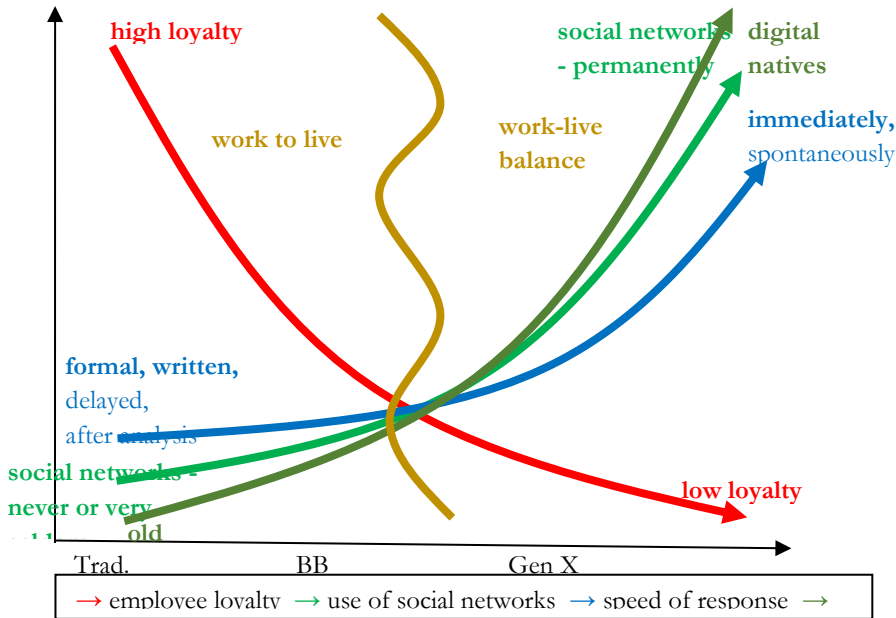
Gen Y freely make decisions whether life or work-related. They are not afraid to open their own business. Martini (2005) indicates that they become the owners of 'Me, Inc. ' (definition in Peters (1997)).

"They know their worth on the labour market" (Barwińska-Małałowicz A. 2011 p. 304). They use the work as an opportunity to achieve other (private) objectives. If they know that by completing the task in a shorter time they will be able to spend the rest of the time on private matters, then they will do the work faster and with greater involvement. It is very difficult determine the dead-line in cooperation with the Gen Y. They are willing to work in teams, and due to their high skills in use of ICT they can work across borders, globally. In such a form of work also helps them tolerance and openness to other lifestyles, cultures and ideologies. Because they like to get the concretized tasks (are task oriented), so they rarely show their creativity in finding solutions. Additionally they are become quickly discouraged when they tend to solutions and faced with difficulties. Unlike previous generations, they cannot imagine of work overtime. If they agree to such a solution, they want to be additionally highly paid. Gen Y are very good adapt to the current trend in search of behaviour patterns: "*Identität, Image und soziale Netzwerke spielen eine immer größere Rolle bei der Arbeitssuche*" (Parment (2013, p. 58): Identification, image and social networks plays increasingly important role in job searching process). They are the youngest of the labour market, but they are best manage new technologies and social networks.

Gentry et al. (2011) examined what are the differences between three generations of managers due to the importance of factors determining Leadership and their practice and skills in 16 areas. In each generational cohort Importance and skills were different ranked. This points to the fact that the validity of the factors selected by the managers do not goes together with their skills. For example for Y-managers very important were following leadership practices: resourcefulness, leading employees and straightforwardness and composure. But in their skill level these factors were on 6, 15, 7 places, and the most important skills of leadership practices were: being a quick study, differences matter, putting people at ease. In every generational groups leading employees as leadership practices was very important but skill level was very low.

After analyzing the characteristics of all the generations presented on the labour market can be find a lot of differences. Examples of differences are presented in Figure 3.

Fig 3: Differences of work attributes and lifestyle among four generations

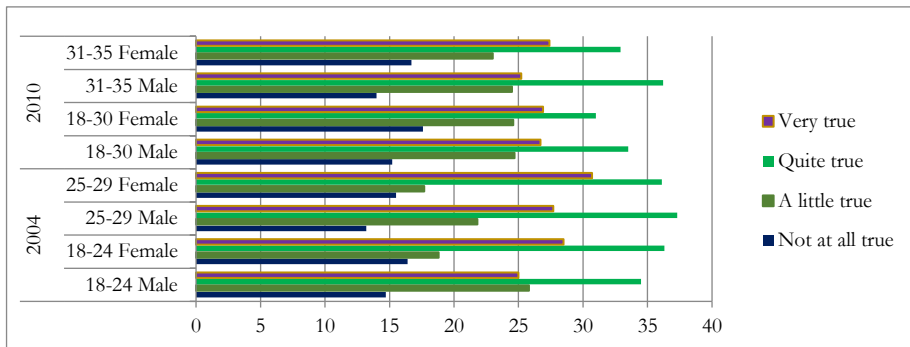


Source: Own elaboration on Bałowska (2013), Hammill (2005), Parry and Urwin (2011), Twenge (2010), Tolbize (2008).

**3. Analysis of perceptions of job safety and the possibility of continuous learning**

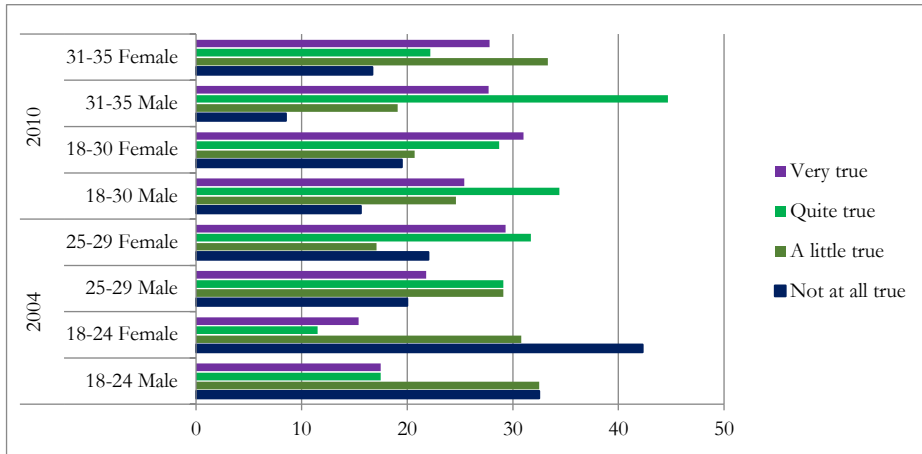
In the Europe 2020 Strategy established in 2010, is indicated fighting poverty and social exclusion as one of headline targets. This action results from the increasing unemployment rate in the European Union. As shown in Stanimir (2014) unemployment rate of Gen Y in the EU decreased in 2006-2008, but from 2009 to 2013 grew. In such a situation, it seems reasonable the question of how youngest employees perceive the stability and job security compared to weaker, than the older generations, loyalty to the employer.

Fig 4. Job is secure - results of the analysis for the respondents from all countries participating in the ESS



Source: Own elaboration on ESS data.

**Fig5.** Job is secure - results of the analysis for the respondents from Poland

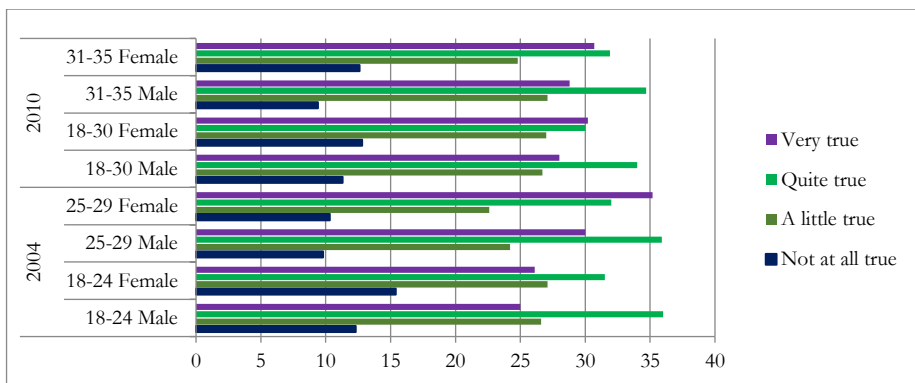


Source: Own elaboration on ESS data.

From figures 4 and 5 it can be seen that in Poland, in both 2004 and 2010 men and women evaluated their job as less secure than all participants of ESS. In Poland in 2004 men and women aged 18-24 assessed the safety of job very unfavourably. After 6 years, they were in the group aged 18-30 years, their assessment of safety has improved, they often chose answers very true and quite true. Analysing the responses of women aged 25-29 in 2004 can be seen that they assess their current job as a highly secure. After six years, their opinions were not so optimistic: the most given answers were a little true. Completely different answered men who in 2004 were 25-29 years: the most common responses were quite true, and a little true. After six years, they better assessed their current work: little true (most replies) and very true. Considering the answers of all respondents in the study of the ESS in 2004 and 2010 there can't be identified changes in the assessment of safety of work. Women aged 25-29 in 2004 and 31-35 in 2010 evaluated their job as the most secure.

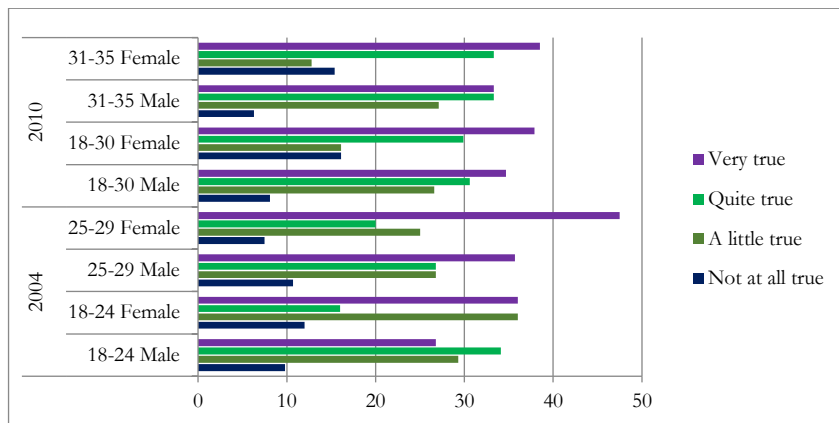
Because the Gen Y declares willingness to lifelong learning, it was chosen in the next analysis variables describing their attitude in this matter. Figures 6 and 7 shows how the respondents evaluated the need to learn new things at work.

**Fig 6.** Job requires learning new things - results of the analysis for the respondents from all countries participating in the ESS



Source: Own elaboration on ESS data.

**Fig 7.** Job requires learning new things - results of the analysis for the respondents in Poland



Source: Own elaboration on ESS data.

Statement that the job requires learning new things was true for those of the countries participating in the ESS in both 2004 and 2010 (for men and women). In Poland, in 2004 women aged 25-29 years in most stated that current job requires learning new things. After six years, their opinion was similar. Among women aged 18-24 years in 2004, the most frequent answers were very true and a little true. However, among women aged 18-30 in 2010 were the most answers: very true and quite true.

#### 4. Conclusions

Combined analysis based on data from the ESS for all the countries analyzed at the same time does not give a good picture of changes in the perception of work. Each country should be considered separately, and the analysis can be enriched with variables describing the economic situation of the country.

Generation Y declare their willingness to learn new things but probably it must be associated with the possibility of achieving additional benefits not only the execution of work. Unfortunately, the formulation of the questions in ESS does not allow to assess satisfaction with need to learn new things at work.

After the analysis of characteristics of all generations on labour market it is clear that in the management of young employees very important are: possibility of professional development access to modern technology, task oriented management and multitasking, continuous feedback. The employer must allow Gen Y to keep balance between work and life. For Gen Y work is the best place for learning soft and hard skills.

#### 5. Acknowledgements

This study was done as a part of the project "Non-metric multivariate data analysis as a tool for study of adults situation in the context of demographic changes" financed by Narodowe Centrum Nauki (National Science Centre) in Poland. Project number: 2012/05/B/HS4/02499.

**References:**

- Acar A. B. (2014). Do Intrinsic and Extrinsic Motivation Factors Differ for Generation X and Generation Y? *International Journal of Business and Social Science*, Vol. 5, No. 5, April 2014, p. 12-20.
- Barwińska-Małajowicz A. (2011). „Y Generation” on the contemporary labour market – dark fiction or completely new quality? *Nierówności społeczne a wzrost gospodarczy*, Wydawnictwo Uniwersytetu Rzeszowskiego, zeszyt 19/2011, p. 301-309.
- Bąkowska J. (2013). *Managing Generation Y Employees in an International Company*, Working Papers in Management, Finance and Economics, Poznań: MBA Poznań-Atlanta.
- Data, ESS Round 2: European Social Survey Round 1. (2004). *Data file edition 3. 4*. Norwegian Social Science Data Services, Norway – Data Archive and distributor of ESS data.
- Data, ESS Round 5: European Social Survey Round 6. (2010). *Data file edition 3. 2*. Norwegian Social Science Data Services, Norway – Data Archive and distributor of ESS data.
- Deal J. J. (2007). *Retiring the Generation Gap: How Employees Young and Old Can Find Common Ground*. San Francisco: John Wiley & Son.
- European Commission (2010). *Communication from the Commission - Europe 2020. A strategy for smart, sustainable and inclusive growth*. European Commission, COM (2010) 2020 final.
- Gentry, W. A. , Deal, J. J. , Griggs, T. L. , Mondore, S. P. , & Cox, B. D. (2011). A comparison of generational differences in endorsement of leadership practices with actual leadership skill level. *Consulting Psychology Journal: Practice & Research*, 63 (1), 39-49.
- Gursoy D. , Maier T. A. , Chi C. G. (2008). Generational differences: An examination of work values and generational gaps in the hospitality workforce, *International Journal of Hospitality Management* 27 (2008), p. 448–458.
- Hammill G. (2005), *Mixing and Managing Four Generations of Employees*, FDUMagazine Online, Winter/Spring 2005, Volume 12, number 2, [Online] Available: <http://www.fdu.edu/newspubs/magazine/05ws/generations.htm> (January 31, 2015).
- Hole D. , Zhang L. , Schwartz J. , (2010). Talking About *Whose* Generation? Why Western generational models can't account for a global workforce, *Deloitte Review* Issue 6, p 83-97.
- Loretto P. Characteristics of the Baby Boomer, [Online] Available: <http://internships.about.com/od/internships101/qt/Characteristics-Of-The-Baby-Boomer.htm> (February 12, 2015).
- Martini, C. (2005). From high maintenance to high productivity. What managers need to know about Generation Y, *Industrial and Commercial Training*, VOL. 37 NO. 1 2005, pp. 39-44.
- Parment A. (2013). *Die Generation Y Mitarbeiter der Zukunft motivieren, integrieren, führen*. Wiesbaden: Springer Fachmedien.
- Parry E. , Urwin P. (2011). Generational Differences in Work Values: A Review of Theory and Evidence. *International Journal of Management Reviews*, Vol. 13, 79–96. DOI: 10.1111/j.1468-2370.2010.00285.x.
- Peters T. (1997). The Brand Called You. Fast Company, August/September 1997, [Online] Available: <http://www.fastcompany.com/magazine/10/august-september-1997> (February 10, 2015).**
- Ruths J. (2014). *Arbeitgeberattraktivität aus Sicht der Generation Y Handlungsempfehlungen für das Human Resources Management*. Wiesbaden: Springer Fachmedien.
- Schroer W. (2015). **Generations X,Y, Z and the Others - Cont'd.** [Online] Available: <http://www.socialmarketing.org/newsletter/features/generation2.htm> (February 10, 2015).

---

Stanimir A. (2014). Participation in the labour market - Generation Y and other age groups. *Academic Journal of Interdisciplinary Studies*, MCSER Publishing, Rome-Italy, vol. 3 no. 3. , DOI: 10. 5901/ajis. 2014. v3n3p111.

Tolbize A. (2008). Generational differences in the workplace. Research and Training Center on Community Living, University of Minnesota, [Online] Available: [http://rtc.umn.edu/docs/2\\_18\\_Gen\\_diff\\_workplace.pdf](http://rtc.umn.edu/docs/2_18_Gen_diff_workplace.pdf) (February 10, 2015).

Twenge J. M. (2010). A Review of the Empirical Evidence on Generational Differences in Work Attitudes. *Journal of Business and Psychology* (2010) 25, p. 201–210.

---

## Career stages and attitudes to skills development process in Poland

Alicja Grześkowiak

Wrocław University of Economics

alicja.grzeskowiak@ue.wroc.pl

### Abstract.

*There is an undeniable need for the continuous improvement of skills and competences in the era of the knowledge-based economy. The necessity of lifelong learning activities is included in the strategic European documents. The degree of achievement of the objectives in the field of adult education varies substantially among the countries of the European Union. The situation in Poland as compared to other countries is unfavorable. This paper deals with the subject of attitudes towards the skills development process of the Polish labor force. The analyses are carried out on the basis of the microdata provided by a Polish nationwide survey on human capital conducted in 2013. According to the Super's theory some career stages combined with age are considered: the exploration, the establishment and the maintenance. A hypothesis is verified that the educational patterns are different at various stages of the career development. As the dataset contains nominal, ordinal and interval variables, some specific statistical methods are applied to identify the associations.*

**Keywords:** skills development; career stages; statistical analysis;

### 1. Introduction

The knowledge-based economy combined with rapid changes incline all members of the labour force to continuously improve skills and competences. Lifelong learning process is an important component of the European Union educational strategies. International comparisons show that in Poland there is a very low percentage of adults engaged in training (European Commission, 2011b). Recent researches concerning Poland (Czapiński & Panek 2013; GUS, 2009; Grześkowiak 2013; Grześkowiak 2014; Grześkowiak 2015) indicate that there are various factors associated with the involvement in educational activities as gender, place of residence, age, income, health condition, labour status, level of education.

The main objective of this paper is to analyze the attitudes towards improving skills with regard to career stages. According to the Super's theory some career phases can be distinguished in relation to age (Super, 1980). In this study the following division adapted from the Super's theory is applied:

- exploration (18-24 years),
- establishment (25-44 years),
- maintenance (45-64 years).

The Super's partition includes more stages like growth and decline (Super, 1980) but they concern persons beyond productive age and therefore are not considered in this paper.

Chosen statistical methods are applied to examine whether there are relationships between the above-defined career stages and various aspects of improving skills: participation in three forms of education, perception of learning new things in the context of the age, the time and the expenditure spent on education.

### 2. Data characteristics and analytical techniques

This research is conducted on the basis of microdata collected during a nationwide survey on human capital in Poland named *Bilans kapitału ludzkiego 2013*. The sample size of this survey is equal to 17 600 individuals in productive age (i. e. 18-64 for men and 18-59 for women). As education plays an important role in human capital formation, the survey includes



a choice of questions concerning the attitudes to skills development process. The variables taken into consideration in this study are presented in Table 1.

**Table 1.** List of variables under consideration

Variable	Description
Participation in formal education (last 12 months)	binary variable
Participation in non-formal education (last 12 months)	binary variable
Self-learning activities (last 12 months)	binary variable
Age as a barrier to lifelong learning activities	binary variable
Ability to continuously learn new things	ordinal variable
Number of years since the last participation in training	metric variable
Number of hours devoted to training (last 12 months)	metric variable
Total personal expenditure on training (last 12 months)	metric variable

Source: own elaboration based on variables from the survey *Bilans kapitalu ludzkiego 2013*

The variables represent various aspects of involvement in activities aiming at developing skills. Although the overall sample size is as mentioned above, no complete data are available for certain variables. In these cases the analyses are conducted on the basis of a smaller number of records (17 597 for *Ability to continuously learn new things*, 2 417 for *Total personal expenditure on training*, 2 432 for *Number of hours devoted to training*, 3 741 for *Number of years since the last participation in training*).

The variables are measured on different scales and therefore various approaches in the analyses are indispensable.

The chi-square test is applied in order to examine associations between pairs of non-metric variables. Since the chi-square statistic depends on the sample size, its usefulness as a measure of association is non convenient, hence the contingency coefficient is used to assess the strength of a relationship as its values are normalized between zero (independence) and one (full association) (Everitt, 1992, pp. 56-57). A directional measure - Goodman and Kruskal Tau having proportional reduction error interpretation is also calculated (see Reynolds, 1984). The associations in three-way contingency tables are evaluated by log-linear modeling (see e. g. Christensen, 1997). Some visualization techniques are applied to illustrate the relationships among nonmetric variables: doubledecker plots and mosaic plots (see Friendly 2000; Hornik, Zeileis & Meyer, 2006) implemented in R *vcd* (Meyer, Zeileis & Hornik, 2014). and *vcdExtra* (Friendly et al. , 2015) packages. In the case of metric variables a preliminary assessment of the compliance with the normal distribution is carried out using quantile-quantile plots and the normality is verified by the Kolmogorov-Smirnov test. The lack of normality limits the possibility of the application of classical ANOVA. Hence, an alternative method of comparison of distributions is a non-parametric Kruskal-Wallis test considered also as the one-way analysis of variance by ranks (see e. g. Sheskin, 2003).

All analysis are performed either in R or SPSS programme.

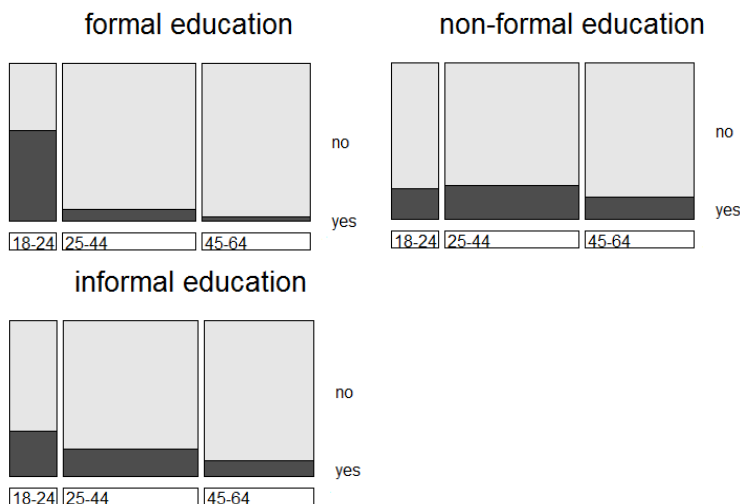
### 3. Career stages and participation in various forms of continuous education

According to the classification of educational activities used in European policies there are four forms of learning (European Commission, 2006; European Commission 2011a):

- formal education, which takes place in educational institutions and is a part of the educational system of the country,
- non-formal education provided outside the educational system,
- informal learning, which is neither organized nor structured,
- random learning, which is unintentional.

The last one is not a subject of statistical observation (European Commission, 2006). The other forms are treated as intentional learning and statistical data may be available on this topic. The Polish survey on human capital covers these three forms of improving knowledge and skills with the informal learning reflected in the questions on self-learning.

Double-decker charts depicting the contingency tables for selected age intervals and forms of education are presented in Figure 1.



**Figure 1.** Doubledecker plots showing relationships between the career stages and the participation in various forms of continuous education

Source: own elaboration in R based on data from *Bilans kapitału ludzkiego 2013*

The biggest differences can be observed in the case of formal education. Participation in the group at the beginning of professional career is much higher than in the others. The tendency towards developing skills through self-education decreases with age.

In order to check whether there are dependencies between the phases of professional development and the participation in various forms of education chi-square test as well as contingency and Goodman and Kruskal Tau coefficients are applied (Table 2).

**Table 2.** Measures of association between the career stages and the participation in various forms of continuous education

Type	Chi-square statistic	p-value	Contingency coefficient	Goodman Kruskal Tau
Formal education	5585,122	0,000	0,491	0,317
Non-formal education	119,665	0,000	0,082	0,007
Informal education	533,317	0,000	0,175	0,031

Source: own computations based on data from *Bilans kapitału ludzkiego 2013*

Chi-square test indicates that there are significant relationships between the career stages and involvement in educational activities. The calculated coefficients allow to perform the comparisons of the degree of association. The largest association occurs in the case of formal education, and the lowest in the case of non-formal education.

As there are three learning forms in question, three-way contingency tables may be examined for detecting interactions among all variables. Log-linear models are applied for this purpose. The results of log-linear modeling are shown in Table 3.

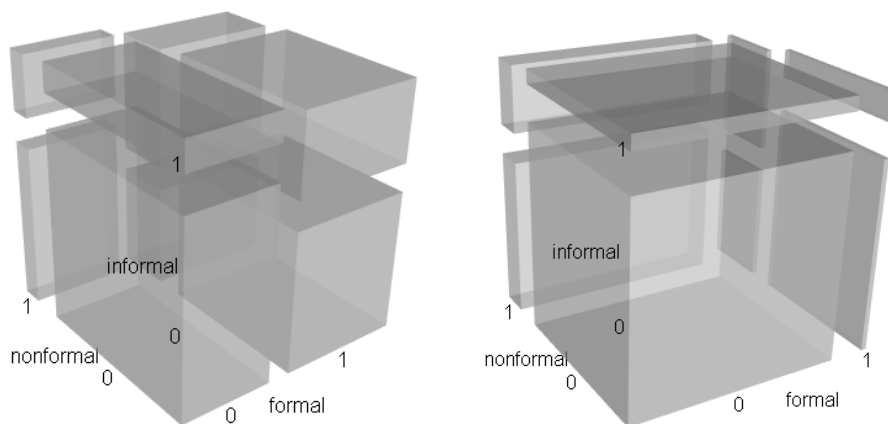
**Table 3.** Best log-linear models for participation in various types of continuous education (F - formal education, N - non-formal education, I - informal education)

Stage	Log-linear model	Likelihood ratio chi-square	p-value
Exploration	[FN][F][NI]	0,765	0,382
Establishment	[FNI]	0,000	1,000
Maintenance	[FN][F][NI]	0,007	0,935

Source: own computations based on data from *Bilans kapitalu ludzkiego 2013*

Simplified models than saturated one are found for relationships of educational activities in case of the *exploration* and *maintenance* stages. The detected pattern is called homogeneous association meaning that no three-way interactions are present. The associations between any two forms of education do not depend on the third one. The third-order effect cannot be omitted in case of the *establishment* stage indicating that there are interactions among all forms of education.

The results of log-linear modeling in case of three variables are portrayed by three- dimensional mosaic plots in Figure 2. The volumes of the cuboids represent the contingency table cells frequencies corresponding to fitted values of log-linear models for *exploration* and *maintenance* categories.



**Figure 2.** Three-dimensional plots corresponding to fitted values of log-linear models for *Exploration* (left) and *Maintenance* (right) : 0 - lack of participation, 1 - participation

Source: own elaboration in R based on data from *Bilans kapitalu ludzkiego 2013*

As the goodness-of-fit of the models is good no meaningful discrepancies are indicated. It should be underlined that the participation in education patterns differ essentially between the youngest and the oldest part of the labour force. The case of the *maintenance* stage is dominated by one big cuboid reflecting the combination of lack of participation in all three

lifelong learning activities. In case of the *exploration* stage the division is not so strongly dominated by a certain combination of educational behaviors.

#### 4. Career stages and attitude to educational activities

As it was shown above the lowest participation rate in lifelong learning activities is observed at the end of the professional career path (maintenance stage). The question is whether the perception of the ability to learn new things differs essentially between respondents from various age groups and whether age itself is considered as a barrier to involvement in training.

Double-decker plots portraying the contingency tables for the age intervals and the evaluation of the ability to learn new things as well as the perception of age as a barrier to learning are shown in Figure 3.



**Figure 3.** Doubledecker plots showing relationships between the career stages and the attitudes to lifelong learning activities

Source: own elaboration in R based on data from *Bilans kapitału ludzkiego 2013*

Persons being at the maintenance stage tend to perceive age as a barrier to undertake educational activities more frequently than the others. Moreover their self-esteem in terms of the ability to learn is lower than among persons at the exploration and establishment stages of career. These differences are also reflected in chi-square test results as well as contingency coefficients (Table 4).

**Table 4.** Measures of association between the career stages and the attitude to lifelong learning process

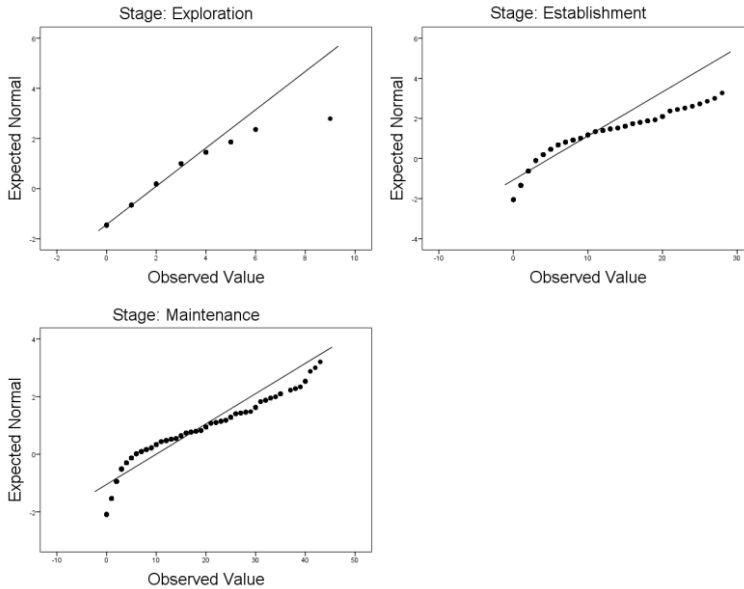
Type	Chi-square statistic	p-value	Contingency coefficient	Goodman Kruskal Tau
Age as a barrier to education	1200,519	0,000	0,253	0,017
Ability to learn new things	847,440	0,000	0,236	0,059

Source: own computations based on data from *Bilans kapitału ludzkiego 2013*

Chi-square test points out that there are significant relationships between the career stages and the considered factors. Low values of Goodman and Kruskal Tau measure indicate that there is a small reduction in error when predicting the attitudes from the knowledge of career stages.

The attitude to learning activities may be also evaluated by analyzing a metric variable representing number of years since the last participation in training. The task is to verify the hypothesis that the average time since the last participation is the

same at all distinguished career stages. In order to check whether classical ANOVA may be applied, quantile-quantile plots (Figure 4) as well as Kolmogorov-Smirnov test of normality (Table 5) are used.



**Figure 4.** Quantile-Quantile plots for *Number of years since the last participation in training* according to three career stages

Source: own elaboration based on data from *Bilans kapitału ludzkiego 2013*

Both plots and test results show that the assumption of normality is not held, so the use of the classical analysis of variance is not possible. The suggested solution is the Kruskal-Wallis non-parametric test. The null hypothesis is that the mean ranks of the variable in question are the same across all categories of career stages contrasted with the alternative hypothesis that it is not true at least in two samples. As Kruskal-Wallis statistics is equal to 558,540 with corresponding p-value 0,000 the null hypothesis must be rejected. The time since the last training differs between the groups which are at different career stages.

**Table 5.** Test of normality: *Number of years since the last participation in training*

Stage	Kolmogorov-Smirnov statistic	p-value
Exploration	0,241	0,000
Establishment	0,216	0,000
Maintenance	0,188	0,000

Source: own computations based on data from *Bilans kapitału ludzkiego 2013*

Pairwise comparisons are performed to evaluate the differences (Table 6). The differences are significant for every pair of career stages.

**Table 6.** Pairwise comparisons: *Number of years since the last participation in training*

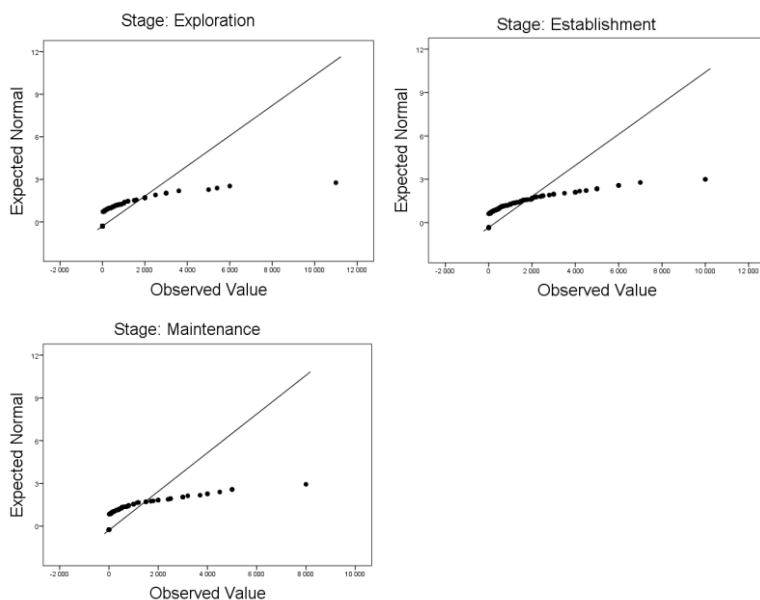
Pairs	Test statistic	p-value	Adjusted p-value
Exploration - Maintenance	-22,336	0,000	0,000
Establishment - Maintenance	-14,741	0,000	0,000
Exploration - Establishment	-13,709	0,000	0,000

Source: own computations based on data from *Bilans kapitalu ludzkiego 2013*

### 5. Time and expenditure spent on training at various career stages

Other indicators characterizing the involvement in the skills development at different career stages are the expenses and the time spent on training. These variables are metric in nature, so either ANOVA or its Kruskal-Wallis analogy are adequate techniques for detecting possible differences.

Quantile-quantile plots (Figure 5) and Kolmogorov-Smirnov test of normality (Table 7) are applied to data concerning the total personal expenditure on training during the last 12 months.



**Figure 5.** Quantile-Quantile plots for *Total personal expenditure on training* according to three career stages

Source: own elaboration based on data from *Bilans kapitalu ludzkiego 2013*

**Table 7.** Test of normality: *Total personal expenditure on training (last 12 months)*

Stage	Kolmogorov-Smirnov statistic	p-value
Exploration	0,385	0,000
Establishment	0,366	0,000

Maintenance	0,412	0,000
-------------	-------	-------

Source: own computations based on data from *Bilans kapitalu ludzkiego 2013*

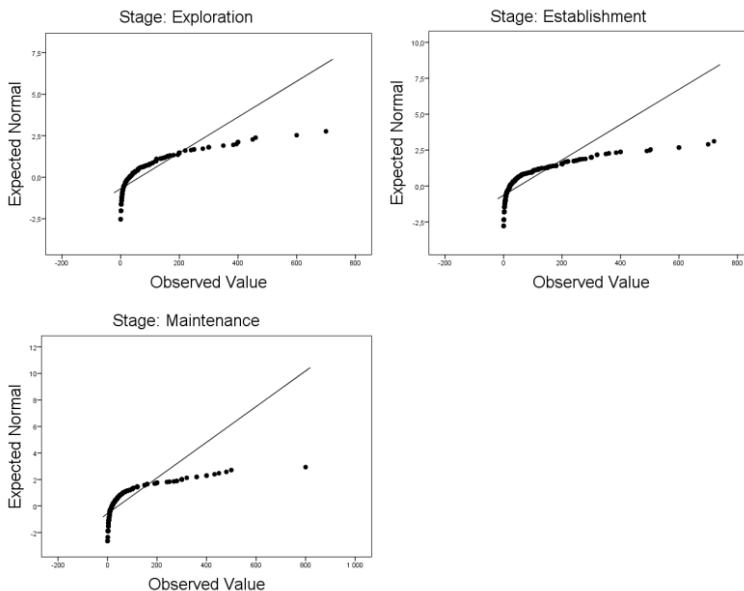
Both quantile-quantile plots and test results indicate that the distributions of the expenses are not normal, so there is no rationale for performing classical analysis of variance. Kruskal-Wallis test is used instead. Its statistic equal to 14,978 with corresponding p-value 0,001 suggests that the null hypothesis of the same distribution of expenses across the three categories should be rejected. The results of pairwise comparisons (Table 8) reveal that the distributions of the expenses differ substantially between establishment and maintenance stages.

**Table 8.** Pairwise comparisons: *Total personal expenditure on training (last 12 months)*

Pairs	Test statistic	p-value	Adjusted p-value
Exploration - Maintenance	1,433	0,152	0,456
Establishment - Maintenance	3,830	0,000	0,000
Exploration - Establishment	-1,658	0,097	0,292

Source: own computations based on data from *Bilans kapitalu ludzkiego 2013*

Normal distribution assumptions are also not met in the case of the variable representing the time devoted to training in the last twelve months (see Figure 6 and Table 9).



**Figure 6.** Quantile-Quantile plots for *Number of hours devoted to training* according to three career stages

Source: own elaboration based on data from *Bilans kapitalu ludzkiego 2013*

**Table 9.** Test of normality: *Number of hours devoted to training (last 12 months)*

Stage	Kolmogorov-Smirnov statistic	p-value
Exploration	0,244	0,000
Establishment	0,263	0,000
Maintenance	0,285	0,000

Source: own computations based on data from *Bilans kapitału ludzkiego 2013*

Again, Kruskal-Wallis test based on ranks is applied to test the mean ranks of the number of hours spent on training. As the statistic is equal to 24,796 with corresponding p-value 0,000 null hypothesis is rejected meaning that the distribution of time is not the same across categories of career stages. Pairwise comparisons are given in Table 10.

**Table 10.** Pairwise comparisons: *Number of hours devoted to training (last 12 months)*

Pairs	Test statistic	p-value	Adjusted p-value
Exploration - Maintenance	4,978	0,000	0,000
Establishment - Maintenance	2,473	0,013	0,040
Exploration - Establishment	3,416	0,001	0,002

Source: own computations based on data from *Bilans kapitału ludzkiego 2013*

Pairwise comparisons lead to the conclusion that the time spent on learning varies considerably between the *exploration* and *maintenance* phases and between *exploration* and *establishment* stages. The pattern of educational behavior for the younger group is different than for the others.

## 6. Conclusions

The attitudes to lifelong learning activities as well as developing skills process are different across persons being at the three career stages. The patterns of association vary with particular variables. Nevertheless, the hypothesis of the same attitudes at all career phases was rejected in any considered case.

## Acknowledgments

This research was financed by Narodowe Centrum Nauki (National Science Centre) in Poland under the project entitled "*Non-metric multivariate data analysis as a tool for study of adults situation in the context of demographic changes*". Project number: 2012/05/B/HS4/02499.

The data on individuals were retrieved from the database *Bilans Kapitału Ludzkiego – 2013* on 2015-01-03.

## References:

- Christensen, R. (1997). *Log-linear models and logistic regression*. New York: Springer.
- Czapiński, J. & Panek, T. (eds.). (2013). Social diagnosis 2013. Objective and subjective quality of life in Poland. *Diagnoza Społeczna 2013. Warunki i Jakość Życia Polaków, Contemporary Economics*, Vol. 7, pp. 1-491.
- European Commission. (2006). *Classification of learning activities - Manual*. Luxembourg: Office for Official Publications of the European Communities.
- European Commission. (2011a). *Adults in Formal Education: Policies and Practice in Europe*. Brussels.



- 
- European Commission. (2011b). *Progress Towards the Common European Objectives in Education and Training. Indicators and benchmarks 2010/2011*. Luxembourg: Publications Office of the European Union.
- Everitt, B. S. (1992). *The analysis of contingency tables*. New York: Springer-Science+Business Media, B. V.
- Friendly, M. (2000). *Visualizing categorical data*. Cary, NC: SAS Institute.
- Friendly M. , Turner H. , Zeileis A. , Murdoch D. , Firth D. (2015). vcdExtra: vcd Extensions and Additions. R package.
- Fischer, M. M. , & Wang, J. (2011). *Spatial data analysis: models, methods and techniques*. Springer Science & Business Media.
- Grześkowiak, A. (2013). Statystyczna analiza aktywności edukacyjnej osób dorosłych w Polsce, *Ekonometria*, 2 (40), pp. 22-35.
- Grześkowiak, A. (2014). Self-learning as a method of improving skills by adult Poles - evidence from non-metric survey data, [in: ] *Proceedings of the 12th International Academic Conference, IISES, Prague*, pp. 486-495.
- Grześkowiak, A. (2015). Wielowymiarowa analiza uwarunkowań zaangażowania Polaków w kształcenie ustawiczne o charakterze pozaformalnym. *Prace Naukowe Uniwersytetu Ekonomicznego we Wrocławiu* (forthcoming).
- GUS. (2009). *Kształcenie dorosłych*. Warszawa.
- Hornik, K. , Zeileis, A. , & Meyer, D. (2006). The strucplot framework: Visualizing multi-way contingency tables with vcd. *Journal of Statistical Software*, 17 (3), pp. 1-48.
- Meyer, D. , Zeileis, A. & Hornik, K. (2014). vcd: Visualizing Categorical Data. R package.
- Reynolds, H. T. (1984). *Analysis of nominal data*. Beverly Hills and London: Sage Pubns.
- Sheskin, D. J. (2003). *Handbook of parametric and nonparametric statistical procedures*. CRC Press.
- Super, D. E. (1980). A life-span, life-space approach to career development. *Journal of vocational behavior*, 16 (3), pp. 282-298.

---

## Trends in the Social Responsibility Expenditures of Small and Medium Enterprises from Oradea

Tomina Saveanu

University of Oradea – Faculty of Economics, tsaveanu@uoradea.ro

Conf. univ. dr. Maria-Madela Abrudan

University of Oradea –  
Faculty of Economics, mabrudan@uoradea.ro

### Abstract

*In the context of corporate social responsibility studies there is a gap in understanding these actions at small and medium enterprises (SME). The processes stimulating social expenditures and the motivations in doing so at this level would provide useful information in explaining this phenomenon. At large corporations CSR is part of strategies, there are employees dealing with it managing CSR budgets. However only in smaller enterprises we can understand the decisions to invest in social actions, the domains of such actions and their perceived impact. Our analysis investigates the social expenditures in the form of donations and sponsorship registered by SMEs reporting profit in Oradea. The data was extracted from the National Agency of Fiscal Administration regarding expenditures of small and medium enterprises in 2013. There are 20% of all SMEs that declare such costs, a percentage that we consider is significant for this phenomenon. In this paper, we explore the extent to which these investments vary depending on the size of the enterprise (measured as business rate and number of employees), profit and domain. As expected the bigger the firm, the higher are the chances to donate money and also the amount donated is higher. Future studies should focus on qualitative data mostly motivations of such expenditures.*

**Keywords:** corporate social responsibility, social involvement, small and medium enterprises

### 1. Introduction

The interest regarding the social involvement of companies has reached high levels in the last years, even if from a research standpoint the benefits can be contested (McWilliams et al. 2005). Practitioners are interested mainly in the effects of such actions for the companies, while lobbyists and policy makers are interested in the community level effects. Beyond the many controversies regarding to which forms of involvement are most important, there is a general agreement that enterprises can contribute positively to development.

Donations and sponsorship are considered at the top of social responsibility actions, as a concrete and specific form of involvement. Other forms include different level policies (environmental protection, human resources, customer relations, etc. ) and actions towards the satisfaction of requests of different stakeholders. Social responsibility is traditionally associated to large companies, multinational corporations however several studies reveal that this is an attitude which may characterize all type of organizations: large and small, public and private, governmental and non-governmental.

In this paper we focus on one of the classical forms of social responsibility of firms – the expenditures for social causes from small and medium enterprises (SME) in Oradea - Bihor County, Romania. This topic is a part of a postdoctoral study regarding the social involvement of Romanian organizations, study in which we try to identify both the forms of such actions, as well as their causes and obstacles. So far we have observed significant information that for Romania it is important to analyze these processes for small and medium companies. Mechanisms that trigger social involvement for these firms can hinder ways to promote such attitude from all companies. More, there is some evidence that the motivations and forms of social involvement of smaller companies bring closer theories of CSR to the one of individual community participation. Active citizenship is a concept that bridges the two directions as it widens the contexts in which social involvement takes place.

---

The analysis of this article started with the main question – is there enough evidence of social activity of SMEs? Due to the availability of data we restricted our analysis to Oradea as we expect that in this regard the differences between counties should not be very large. More, knowing the fiscal facility regarding the deduction of taxes for donations or sponsorship we limited the search for evidence of social involvement of small and medium enterprises in Oradea, Bihor county to this form of action. We are aware that there are other ways SMEs may get involved in their community, however this is one of the key forms considering CSR theory, and thus defining for this phenomenon. The first question this paper is answering is *to what extent small and medium enterprises from Oradea donate money as social involvement actions?* More, aiming at the characterization of this process we answered to the second question: *which are the firm level characteristics that stimulate such actions?*

## 2. Social responsibility: discourse or reality?

### 2.1. General framework

Social responsibility of organizations can be considered a new paradigm regarding business-society relationship (Saveanu et. al. 2014). The topic has gained high notoriety in the last two decades both from theoretical and practical perspectives. Nonetheless theoreticians did not yet reach full consensus regarding the concepts used (corporate social responsibility or performance, corporate citizenship, corporate sustainability and the list can continue) as well as regarding what constitutes social behavior on behalf of organizations (Aguinis and Glavas, 2012). The most widely used concept remains corporate social responsibility (CSR) and the distinctions between this and other terms are not that clear-cut. In this paper we will refer to CSR, acknowledging that such social attitude can be observed generally in organizations private as well as public, large as well as small (Acar et. al. 2001).

We are considering a narrow definition of CSR as “actions that appear to further some social good, beyond the interests of the firm and that which is required by law” (McWilliams et. al. 2005, p. 3). A classical, yet broader, approach was developed by Carroll (1979, 1991) comprising all economical, legal, ethical and discretionary responsibilities of a company. We consider that the first two are mandatory to all firms and as such should not be considered when deciding when a company is socially responsible and not. Even following such an approach CSR can be contested as being purely discourse in the form of PR propaganda or another form of domination of large companies (Banerjee, 2007). The difficulties in assessing the impact (Barth et. al. 2007) rise also questions regarding which actions are relevant in considering social responsibility and also which are the more profitable investments for companies as well as for society as a whole (Knox și Maklan, 2004).

Measuring CSR is one of the core problems and a requiring critic within this topic. It starts with deciding which actions can be considered socially responsible ranging from mission statements to direct involvement in community programs. Some theoreticians argue that the motivations behind each action are the ones that make the difference between opportunists and “true” CSR, however practitioners consider that it should be a win-win context. If we disregard the reasons behind such actions one of the areas which does not raise question marks whether it represents or not social responsibility is represented by offering money to charities or social campaigns. Donations and sponsorships are at the top of CSR pyramid (Carroll, 1991). This is the level of CSR we focus on in this paper: the donations offered by small and medium enterprises in Bihor County. Information regarding the destination of this money was not available and consequently it is impossible to discuss the impact of these payments. More, qualitative data is needed in order to clarify the motivations behind these investments and the choice for the beneficiaries.

Regarding the factors that stimulate social responsibility the literature highlights both subjective (manager level factors such as motivations and attitudes) and objective factors. Lindgreen (2009) shows that the interests regarding different stakeholders changes depending the level of development of the firm. At the begging, with few employees and lower incomes, companies will be interested in primary stakeholders (such as clients), however as the company grows it integrates social objectives into its strategy and invests systematically in these actions. Consequently we will expect that this trend can be observed when analyzing small and medium enterprises (up to 250 employees), as we are investigating the relationship between the decision to donate money and the size of the firm.

## **2. 2. CSR policy in Romania in the European context**

European Commission uses the concept of social responsibility of enterprises as a larger context than corporate social responsibility. The definition is derived from the narrow approach of CSR as the "capacity of enterprises to voluntarily take up actions, beyond their legal obligations, to achieve social and environmental objectives in their everyday activity" [authors' translation based on the definition posted on <http://ec.europa.eu/social/main.jsp?langId=ro&catId=331>]. However the levels considered by the Commission as relevant for enterprises in this matter are structured on the legal which is mandatory and voluntary: "integrating social, environmental, ethical, consumer, and human rights concerns into their business strategy and operations" ([http://ec.europa.eu/growth/industry/corporate-social-responsibility/index\\_en.htm](http://ec.europa.eu/growth/industry/corporate-social-responsibility/index_en.htm)).

There are several documents assumed or agreed upon by the European Commission regarding CSR. These include policies promoting social responsibility of enterprises in Europe (Green papers and Strategies of CSR), standards and performance parameters (ISO 26000 Guidance Standard on Social Responsibility), evaluations and comparisons of achievement of these standards and the objectives set in the strategies.

Within the European frame, the social responsibility of small and medium enterprises was considered a priority of the European Alliance on CSR (COM (2006) 136). In the light of this approach SMEs are considered to have a great role in sustaining a responsible business environment and as promoters of such an attitude. However in consequent evaluations it was noted that the impact of CSR policy on SMEs is small as their social actions will be inconsequential and unintegrated in a strategic approach. Consequently the impact of such actions will be less relevant than those of large companies and programs proposed by alliances (COM (2011) 186). Nonetheless we consider that the European focus on SMEs' CSR provides enough context for furthering research on this topic. Consequently we reflect in our study some of the efforts made in this regard by SMEs in Oradea, namely in the form of donations or sponsorship.

Through the European level studies and assessments of CSR impact, some conclusions regarding Romania can be drawn. Up to last year, comparative studies reveal the lack of maturity mostly by Romanian agencies in fostering CSR initiatives but also by Romanian business in engaging in such actions. Even if several steps were undertaken with the elaboration of a national strategy and the initiation of specific actions, these are fragmented, lack transparency, are dependent on external funding and are insufficiently monitored and reported (Williamson et al. 2014). As such, the National strategy for promoting social responsibility (2011) has little visibility and was not translated into concrete action plans and steps towards its implementation. This strategy (2011) defines the national priorities in a wide range of domains from social security to work, environment and education. Both the priorities and the strategic objectives have a high degree of generality which make them harder to measure. The action plan presented in the end of this strategy defines general guidelines on each priority and sets responsibility areas; however it lacks concrete steps to be undertaken by each identified actor and, as so many other similar documents in Romania, remains without practical applicability.

If one considers the narrow view of CSR, the legal aspects are relevant if considered as facilities meant to stimulate such actions and not the mere obedience to the law. As such, in Romania there are several fiscal initiatives for enterprises meant to stimulate social actions. There are also more targeted initiatives regarding employment/human capital or the environment but these are not the object of the current analysis. We refer mostly to the Fiscal Code by which people can direct 2% of their taxes to a specific NGO (art. 84 (2)- (3)) or the deduction of 20% of the due tax of amounts offered as sponsorship or donations (art. 21, lit. p). These mechanisms stimulate directly enterprise philanthropy – the top of Carroll's pyramid (1991). The promotion of these mechanisms in Romania is conducted mainly by the beneficiaries of such initiatives / NGOs whose activities can be financially supported with these sums.

In our analysis we focus on the latter instrument, the deduction of 20% of taxes for donations, aiming at the assessing the impact at small and medium enterprises in Oradea. More, we will also analyze the profile of the enterprises undertaking such investments.

## **3. Social responsibility of small and medium enterprises in Oradea**

### 3. 1. Research methodology

The objectives of this paper, were both to assess the extent to which small and medium enterprises use the fiscal facility of deducting up to 20% of taxes as donations or sponsorship, and also to analyze the profile of the SMEs which declare such costs. In order to achieve these objectives we analyzed data provided by the National Agency of Fiscal Administration regarding expenditures of small enterprises in 2013. We considered companies which registered profit as only these can deduct taxes as donations. The available data in order to have a homogenous sample included the whole population of small and medium enterprises.

The main data reflects the amount of money offered as donation or sponsorship. In order to create the profile of companies which have social investments, we collected also data regarding the size of the enterprise: number of employees, profit and turnover. Unfortunately there was no data available regarding the destination of donated money, data that would shape the profile of social investments of small companies.

### 3. 2. Main conclusions

Out of the total 14. 562 active SMEs registered in Bihor county in 2013 (according to the National Institute of Statistics: <http://statistici.inse.ro/shop/>), there are 2782 which declared profit to the Agency of Fiscal Administration. As presented in Figure no. 1, 18% offer different amounts as sponsorship or donations.

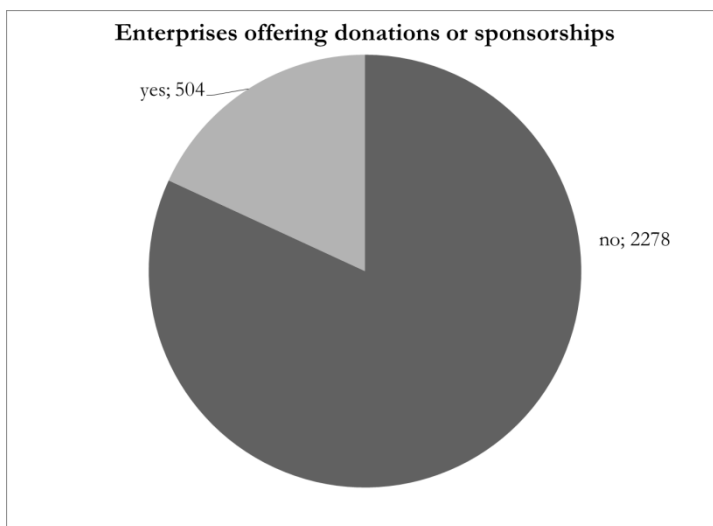


Figure no. 1. Number of small enterprises from Bihor County offering donations, Agency of Fiscal Administration, own calculations

Even if this percentage seems rather small (and 3,4% is even smaller when reported to the total number of small enterprises), we consider that it is significant for social responsibility of these enterprises. This finding supports previous conclusions regarding the openness of micro and small enterprises in Romania towards social responsibility actions (Saveanu et. al. 2014). We thus reinforce the conclusion that CSR of SMEs is an understudied phenomenon that should gain more attention by researchers.

The average money donated is of 2685 lei, about 600 euros. The data reeving the profile of donations is presented in table 1 and the normal distribution of the sums offered as donations can be observed in figure no. 2. Unfortunately there

was no data regarding the destination of this money: NGO's, campaigns, or individuals. This type of information is fundamental in a creating a complete picture of social actions supported by these firms.

Table no. 1. Description of donations offered by small enterprises from Bihor County offering donations, Agency of Fiscal Administration, own calculations

No. Cases	504
Mean	2685,35
Std. Deviation	3821,83
Minimum	10,00
Maximum	37814,00
Sum	1353417

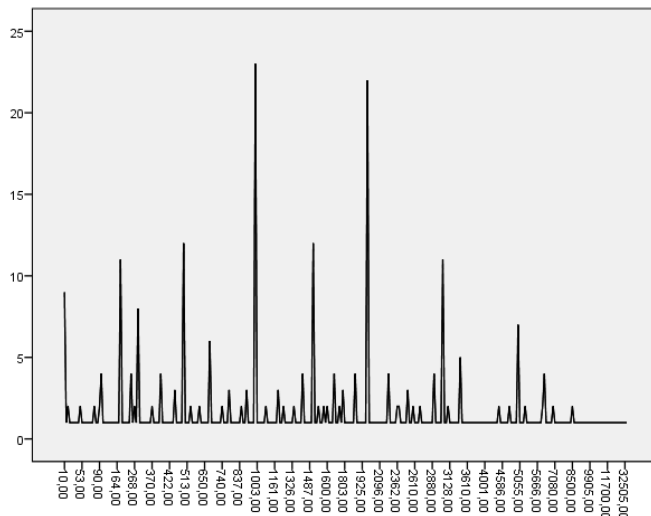


Figure no. 2. The distribution of donations offered by small enterprises from Bihor County offering donations, Agency of Fiscal Administration, own calculation

Turning to the profile of the enterprises which financially support social actions, we investigated one of the classical determinants of CSR: size of the enterprise (Lindgreen et. al. 2009). Consequently we tested the relationship between the donated amounts and number of employees, profit, and turnover.

All three considered independent variables considered significantly correlate with the donations and sponsorship: turnover ( $p=0.681$ ,  $sig=0.00$ ), profit on reference year ( $p=0.586$ ,  $sig=0.00$ ) and number of employees during the reference year ( $p=0.139$ ,  $sig=0.00$ ). These data support the conclusion that the amounts donated by companies are increase along with the increase in profit, turnover and number of employees: as a firm is growing so are the chances it will display this form of social responsibility.

More, regarding the influence of profit we could investigate also rather there are differences between the forms that donate and those that do not. Again, through T-test we can highlight a positive relation: the average profit is significantly higher for the companies who donate money than those that do not ( $F=1.74$ ; equal variances not assumed;  $sig.=0.00$ ).

We need to compare the group of SMEs to large companies, and to make comparative analysis between the group of small vs. medium enterprises in order to generalize this conclusion. At this point we have found important evidence that within the small enterprises the social responsibility actions are influence by the level of development of the firms.

#### 4. Conclusions

We can say that the incidence of the fiscal facility regarding tax deduction for donations and sponsorship is of 18% among the profit gaining small and medium enterprises in Bihor County. The factors facilitating such actions on behalf of enterprises are the profit, turnover and number of employees. Both the existence of donations, and the amount spent in this manner

are influenced by these aspects related to the size of the firm – the richer and larger a small firm chances increase to donate, and the sums increase along with the development of such firms.

As mentioned above, this conclusion was validated solely for the small and medium enterprises and further analysis should extend the comparison with large enterprises. Nonetheless there is evidence to suggest the same pattern in general. Another limit is the result of the lack of information regarding the destination of this money. In order to complete the image regarding social responsibility actions at the top of Carroll's CSR pyramid we need information regarding the actions that are actually funded through these donations and more information on how where these social actions chosen.

This paper fills in an important gap in the knowledge regarding CSR in Romania, as well as CSR within SMEs. The main conclusion is that within these enterprises there is an important orientation towards social actions which need to be understood better. More, understanding the mechanisms that stimulate the investment in social actions at the level of small enterprises would improve our knowledge regarding these processes and consequently would highlight methods for promoting social involvement of companies.

### Acknowledgements

This paper has been financially supported within the project entitled „SOCERT. Knowledge society, dynamism through research”, contract number POSDRU/159/1. 5/S/132406. This project is co-financed by European Social Fund through Sectoral Operational Programme for Human Resources Development 2007-2013. Investing in people!”

### References

1. Williamson, N. , Stampe-Knippel, A. , Weber T. , 2014, Corporate Social Responsibility National Public Policies in the European Union - Compendium 2014, European Commission Directorate-General for Employment, Social Affairs and Inclusion, accessed online on 05. 12. 2014 at <http://ec.europa.eu/social/BlobServlet?docId=12899&langId=en>
- 2.\*\*\*, COM (2006) 136: Communication from the Commission to the European Parliament, the Council and the European Economic and Social Committee - Implementing the partnership for growth and jobs : making Europe a pole of excellence on corporate social responsibility, Comisia Europeană, Brussels 2006, accessed on line on 12. 12. 2014 at <http://eur-lex.europa.eu/legal-content/EN/TXT/PDF/?uri=CELEX:52006DC0136&from=RO>
- 3.\*\*\*, COM (2011) 681: Communication from the Commission to the European Parliament, the Council, the Council and the European Economic and Social Committee - A renewed EU strategy 2011-14 for Corporate Social Responsibility, accessed online on 16. 12. 2014 at : <http://eur-lex.europa.eu/LexUriServ/LexUriServ.do?uri=COM:2011:0681:FIN:EN:PDF>
- 4.\*\*\*, National strategy for the promotion of social responsibility 2011-2016 [Strategia Națională de Promovare a Responsabilității Sociale 2011 – 2016], accesed online on 20. 12. 2014 at <http://www.sgg.ro/nlegislativ/docs/2011/05/2x4bdfjnwskv89h17pzz.pdf>
- 5.\*\*\*, Fiscal Code, Law no. 571/2003, last update through Law no. 123/2014, accessed online on 12. 12. 2014 at [http://static.anaf.ro/static/10/Anaf/Legislatie\\_R/Cod\\_fiscal\\_norme\\_2014.htm](http://static.anaf.ro/static/10/Anaf/Legislatie_R/Cod_fiscal_norme_2014.htm)
6. Carroll, A. B. (1991). The pyramid of corporate social responsibility: Toward the moral management of organizational stakeholders. *Business Horizons*, no. 34, 39-48
7. Carroll, A. B. (1979). A three-dimensional conceptual model of Corporate Social Performance. *Academy of Management Review*, 4 (4), 497-505
8. McWilliams A. , & Siegel, D. (2001). Corporate Social Responsibility: A Theory of the Firm Perspective. *The Academy of Management Review* 26 (1), 117-127
9. McWilliams A. , Siegel, D. , & Wright, P. (2005) Corporate Social Responsibility: Strategic Implications. *Rensselaer Working Papers in Economics*, no. 0506, accessed online at <http://www.economics.rpi.edu/workingpapers/rpi0506.pdf> on 06. 05. 2014
10. Saveanu, T. , Abrudan, M-M, Giurgiu, A. , Mester, L. , Bugnar, N. , 2014, Measuring Corporate Social Responsibility Practices of Micro And Small Enterprises – Pilot Study, in course of publication at *Proceedings of The 8th International Management Conference "Management Challenges For Sustainable Development"*, November 6th-7th, 2014, Bucharest, Romania

- 
11. Aguinis, H. , Glavas A. , 2012, What We Know and Don't Know About Corporate Social Responsibility: A Review and Research Agenda, *Journal of Management*, vol. 38, no. 4, pp. 932-968
  12. Acar, W. , Aupperle , K. E. , Lowy, R. M. , 2001, An empirical exploration of measures of social responsibility across the spectrum of organizational types, *International Journal of Organizational Analysis*, vol 9, no. 1, pg. 26-57
  13. Banerjee, S. B. (2007). Corporate Social Responsibility: the good, the bad and the ugly. *Critical Sociology*, 34 (1), 51-79
  14. Barth, V. R. , Wolff, F. , & Schmitt, K. (2007). CSR between Rhetoric and Reality. *Ökologisches Wirtschaften*, no. 4, 30-34.
  15. Knox, S. & Maklan, S. (2004). Corporate Social Responsibility: Moving Beyond Investment Towards Measuring Outcomes. *European Management Journal*, 22 (5), 508–16
  16. Lindgreen, A. , Swaen, V. , Johnston, W. J. , 2009, Corporate Social Responsibility: An Empirical Investigation of U. S. Organizations, *Journal of Business Ethics*, vol. 85, pp. 303–323



---

## Philosophical Didactics: How Creativity can be Compatible with Critical Thinking

Jūratė Baranova

Liutauras Degėsys

Department of Philosophy,

Lithuanian university of educational sciences

+37065063274

[jurabara@gmail.com](mailto:jurabara@gmail.com)

### Abstract

*The modernistic model of upbringing emphasizes more cognitive, instrumental competence, and underlines the importance of critical thinking. The postmodern model of upbringing induces more interdisciplinary and creative thinking. The authors of the article raise the following question: is creativity compatible or incompatible with critical thinking? Relying on their own experience of textbooks writing and implementing in practice, the authors of the article are searching for a concordance between these two seemingly different capacities of the human mind and the two models of upbringing. The article deals with the theoretical, methodological and practical aspects of modern and postmodern philosophical didactics and discerns the practical perspectives of their possible conformity.*

**Keywords:** critical thinking, creative thinking, modern didactics, post-modern didactics teaching philosophy

### The Investigation of the Problem in Lithuanian Academic Discourse

In Lithuanian academic discourse, the specifics of the modern and post-modern approach towards didactics without an emphasis on their opposition were discussed by Lilija Duoblienė. In her textbook *Contemporary Philosophy of Education: Towards Reflection and Dialogue* (2006), Duoblienė analyzes the main paradigms in the contemporary philosophy of education: pragmatist (John Dewey), existential, phenomenological (Maurice Merleau – Pointy), and analytic (Karl R. Popper), which according to our view could be considered as belonging to the modernistic model of upbringing. On the other hand, Duoblienė discusses the features of the post-modern model of upbringing with emphasis on uncertainty in Jean-François Lyotard and Richard Rorty's conceptions. When discussing the methods of upbringing, the researcher interlaces modernist (Hans-Georg Gadamer, Paul Ricoeur, Martin Buber) and post-modernist (Jacques Derrida, Robin Usher, Richard Edwards) approaches towards educations without discerning the radical distinction between the two. Such an approach by the author perhaps presupposes that postmodern upbringing could be considered as part of the modernist model of education.

In Duoblienė's monograph *Ideological Territories of Educational Change* (2011), a consecutive order is also made in turn from the analysis of the modernistic models (pragmatist, constructivist and phenomenological) of education to the creative strategies in education which can be discerned in Michel Foucault's texts. Duoblienė writes: "The postmodernists are linking the problems of education as well as the problems of all other spheres with the usage of language, its many-sidedness, playfulness and instability. When the attempt to catch the meaning is made, the meaning is always slipping out. So most of the post-modern insights (e. g. by J. -F. Lyotard, J. Derrida) are linked with the text and self-reflection necessary for its reading, also part of them (e. g. by M. Foucault) – with the other social segments: economy, culture and politics, of course, recognizing the practices of regimes and the relations of power in social life" (Duoblienė, 2011: 90). The author also discusses the possibilities and limitations of the usage of Richard Rorty's vocabulary of ironic language in education. Duoblienė emphasizes not only texts and self-reflection, but also dialogues and metaphors as instruments of post-modern upbringing.

The question thus arises: what could be the relation between the modern and post-modern models of education in teaching philosophy and philosophical ethics? On the other hand, what are the possible theoretical presuppositions on which the

---

features of this relation could be based? What methods could be suggested in the process in philosophy teaching uniting the modern and post-modern approaches? Is the mutual complementarity of these two approaches possible or at least the discordant harmony of the two?

### On Traditional and Modern Education

The principles and standards of so called objective or traditional pedagogy are determined by the theoretical preconditions of scientific thinking that emerge from the theoretical reconstruction of the reality by exact sciences. If reality exists as irrespective of our analysis and of ourselves then scrutinizing and analyzing “scientific” glance does not change the reality at the time of investigation and we may see the reality “as it really is”. This enables us to look at the reality “objectively” – free of any interest or subjectivity. When a scientist seeks for the truth he eliminates himself as a subject from the process of cognition in favor of objective attitude, the objective truth, in favor of the possibility to see the world what it really is rather what it looks like to him. The principle of “eliminating” the subject may also result from the standard (metaphysical, mechanical) construction of a cognitive subject-object opposition when the subject as though stood in front of an objectively, “naturally” existing reality and because of this position the subject seeks to get the objective knowledge of the reality that opposes him.

This mental construction of “self-renunciation” or desubjectifying the subject is realized into objective, traditional pedagogy when a studying person is declared to be the object, the target of the educational, teaching process. A student must be ready to be “taught”, that is to be like a vessel that is being filled in with knowledge. The *traditional concept of education* is based on the idea of the importance of knowledge: knowledge is declared here to be the greatest and independent value, the objective of the educational process, whereby imperceptibly turning that vessel – a student – of knowledge into an instrument, a means, simply a depository. The exact sciences have refined the tradition of observation of reality turning it into a ‘cinematographic’ mode of registering reality as a constellation of things. The processes of reality are dissolved by the different sciences into the aggregates of fixed facts which are later one turned into *things* with the help of a whole lot of constructions, methods, instruments and experiments. Sciences teach us to study, analyze, and describe things on the purpose to get *results*. Processes then seem to take a backstage position, whereas the goals of human activity are now declared its results, but not the activity nor the process itself.

The knowledge is the equivalent of the material, finite, objective world, so it should be no less material and objective as the world itself, so the knowledge may be, like the things of the reality, be handed over, transferred, transported from the one place to another one. The knowledge is treated and measured as the sufficient amount of information about reality with a purpose to change and transform this reality. Knowledge is understood as a tool or as a tool-kit for operating on reality; knowledge was considered to give the beholder a power to react to reality and get the desirable results. Thus the extracting, categorization, storage and transmission of knowledge became the main worries of education. Such a concept of education was based on a material approach to the world and a mechanical and metaphysical understanding of the world. If the world contains finite and definite amount of things, if the world itself is a comprehensible “thing” then the knowledge one can gain about such a world is as well finite (“definite”): one can understand and know the world in a finite way. If such were the case, through knowledge acquisition and learning one would reproduce the constructions of finite things, recreating the existing and objective structures of things by copying or reconstructing them, making copies of things in the form of knowledge. Although these structures can be very complex, their technical reproduction can be considered as finite, because they hold finite information.

“In the field of education theory, such types of material construction of the world corresponds to the classical disjunction between the subject and object of learning understood as teaching or educating. Here, on the one hand there are “educators” who are the subjects or actors, or “those who” organize the process by setting goals, select the tools, and take the responsibilities for the results; on the other, there are the learners or objects – things, or “those to whom” the process is meant as receivers, that is those who within a given frame or education model are modeled, formed and changed (they are taught). The implications of this disjunction of subject and object of the learning process as applied in this education model are such that the subject (“agent”, “actor”) is the teacher, the learner therefore becoming an object. This means that as an object of the process, the learner is, a mere passive and indifferent element with no responsibility for the process of education. The teacher as a subject, as the main manager of process of education is responsible for everything. This model

---

does not leave any room for creativity or originality, but this is not all. What is even more, this model implies the denial of individuality, subjectivity and personal commitment for the results and sense of education” (Degésys 2011: 48).

Many traditional educational systems pretend to declare they are modern. But if the goal of education is the knowledge itself then usually all the “modernity” in education turns into the “modern” methods and principles of categorizing, transmitting, storing, controlling and inspecting knowledge. Contrastingly, in an ever-changing social reality it is not possible to operate with a constant concept of “social thing”. Every attempt to simplify, to construct social reality as a thing, as a constant, fails in the face of *changing* social reality. You may try to make a copy of a thing, but even in the world of things you may be confused by the question of “how many “true” copies may I gain from the one thing?”. In the world of social processes, can one make a constant copy of permanently changeable reality? The more complex situation is the less sufficient is a simplification or model. The stereotyping of social reality unavoidably leads to or ends up in a mythologizing of social life. If the social life is interactive and reflective it is unavoidable to be interrelated to other agents and actors of social change. The exploring and learning become the permanent interpretation and re-interpretation of social reality, the reflection of what is going on and the assessment of changes that should be relevant to our changeable social reality.

The concept of modern education is based on the assumption that processes of teaching and learning are implemented in everyday life situations, in the ordinary flow of social reality, in every social activity. Social space requires a constant inter-subjectivity, interactivity, a certain formalization and interpretation of the unceasing social relations and ever-changing interpersonal situations. These learning and teaching processes are inseparably integrated into social activity. Due to the permanent change in the social world it is simply impossible and even meaningless to study and learn only about social standards and operate with social constants. A person who is unable to analyze changing current situations and cannot interpret and re-interpret social factors is simply doomed to an unsuccessful socialization. Furthermore, in a social reality subject to constant changes the capacity to re-set oneself into ever-changing social contexts gains a vital significance. The only rational behavior left as a choice is precisely the ability to gather momentum, perceive the signals from the surrounding social reality and, with the help of analysis and interpretation mechanisms, search for the most successful and appropriate ways to respond to those stimuli and change one’s (teaching or learning) behavior.

If the education process is understood as an inter-subjective communicative act based upon interpersonal relationships, a process that brings forward the standard questions of social recognition and knowledge then the education should be considered as a possibility of self-comprehension, self-education and self-development. Life is a permanent construction and re-construction, programming and re-programming. Deconstruction is a method of vision and interpretation the world, as well as a way of living. It always implies a certain re-construction with the two meanings of this concept: the re-creation of constructions based on reality and the application of these constructions to the recycling of reality, based on the principles of reality.

### **On Teaching and Learning of Critical Thinking as Self-teaching and Meta-learning**

The modern education should be considered as a possibility of self-comprehension, self-education and self-development. Life is a permanent construction and re-construction, programming and re-programming. Thus we need new principles and new standards of teaching and learning should that should be based on the modern education program that develops human universality, independent thinking, openness to change and freedom. This educational approach functions as an inseparable possibility to knowledge, understanding and ability. Knowledge grants the possibility to evaluate processes, that is, to raise questions, and look for meaning, and once the person has found it, he/she can form his/her own opinions and attitudes, gain skills, and make rational use of one’s abilities. Teachers should be taught by the same procedures we expect them to use in their teaching. If we expect them not only to act, or not only use this “learning by doing”, if we expect them encourage students to think, we should encourage the trainers in thinking about thinking. We should stress the importance of *mental, cognitive* acts, but we should stress the importance of *meta-cognitive* acts (Knowing about knowing of others, remembering that others remember, and so on), and the importance of *meta-affective* acts (such as willing to love, desiring to desire). If we want teachers to improve their reasoning skills we should encourage them to reason about how they reason, what are the techniques and technologies of improving the reasoning processes. They need the theoretical analysis of phenomena of education that is based on the philosophical works not only by Plato, Jan Amos Comensky, John Dewey, but also by Henry Bergson, Karl R. Popper, Peter L. Berger and Thomas Luckman also on ideas of philosophy of education by Matthew Lipman

and Ivan Illich. Principles and concepts of theoretical analysis of basic principles of philosophy such as objectivity, determinism, expedience, distance, theory and meta-theory should be structured and explained in their relationship to the principles of education. The process of education itself should be revealed and explained by the very principles of social communication: as the process of permanent interpretation and re-interpretation of social reality, the reflection of what is going on and assessment of changes that should be relevant to the changeable social reality. Thus in the process of education the teaching and learning is transforming themselves into self-teaching and meta-learning. The process of education should be analyzed as a whole set of very effective and modern methods and principles of education, such as the methods of mental experiment, self-analysis and self-reflection, logical alternative calculation, logical analysis and critical thinking and should be based on such thinking and ethical strategies as empathy, de-centering from the self and moral imagination. „The self-learning teacher should know how to teach himself and apart the professional competencies he needs very general competencies – **competences of critical thinking**“ (Degésys 2011: 52). It becomes very important to develop the possibility to raise questions and doubts, and not the necessity to find and provide univocal answers. This possibility can be realized through a meta-relationship - one's own relationship with oneself and with others. Evidently, these assumptions presuppose permanent, inevitable reflection and a meta-relationship with oneself. When reflecting, the individual observes him/herself as the object under analysis and then he/she determines what he/she could and would like to do with him/herself and by him/herself.

In the classical situation of education where there is one educator and others are learners, there is a prevailing passive attitude of observance. One can easily imagine a certain state of expectancy, as the learner passively lets him/herself “be taught, educated”. He/she transfers all the competences of the subject to the “real” educator, a kind of demiurge, organizer or planner. This passive state does not require any subjectivity, responsibility or initiative. In the classical conception of the education process, the responsibility is simply passed on to the one who takes it in order to get out of the learner an expected social product. In the classical conception of the education there seems to be no question about the *personalization* of the education process: in the objective process of objective knowledge transference knowledge is considered a thing to be transmitted from a material collection of knowledge pieces into the no less material head of the learner who is ready to receive it.

Modern education is inevitably based on the **competence for independent thinking**. Self-correction and self-education need an ability to decide independently, the ability to test their own theories and verify assumptions, falsify own attitudes and ideas. This is the reason why in the teaching and learning process a specially introduced, visible, controlled and intentional *distance* is so important: how helpful it is to understand the importance of a meta-theory. A constant analysis and control of the educational situation is inevitable. The education process offers the possibility of continual reflection of the situation under analysis with the introduction of a constant complimentary point of meta-analysis, when one not only observes and discusses what and how it is going on, but also raises the question about the meaning of this specific situation, and about the meaning of the analysis of this question, about the effectiveness of the methods and methodologies used.

Of a great importance in modern education are “unpractical”, meta-practical, theoretical, especially meta-theoretical disciplines, that provide not only with specific, “pedagogical” knowledge, but also turn the subject of learning towards itself, disciplines that teach not only knowledge, but teach the ways of acquiring new knowledge, teach, how to learn discipline and how to teach oneself. “Whatever the theory, it must be one based on the concept of self-possession, it has to consist of a self-development principle and as any theory, and it has to contain methods, a methodology, an organizational structure, criteria and principles of analysis of their effectiveness, all of which should match this original principle of self-education” (Degésys 2011: 57).

### The Presumptions of Creative Thinking in the Post-modern Philosophical Upbringing

When modern didactics requests methods based on logical analysis and critical and creative thinking, the post-modern didactics enlarges the limits of the intellectual creative imagination and opens up the possibility for poly-semantic, deconstructing and rhizomatic aspects in thinking. These aspects train the flexibility and inventiveness of thinking and the openness to unexpectedness and experiment, and afford the capacities for orientation in changing contexts, enabling the easy trespass of different spheres of thinking and help the students to grasp what the contemporary world is about. Post-modern philosophical didactics reflects one of the main features of contemporary culture – its turn towards visual culture.

As Duoblienè writes citing Neil Postman and Marshall McLuhan, the contemporary content of upbringing has to correspond to the contemporary world students are living in. The technologies of this world allow them access to information and to create different structure of thinking, which McLuhan names 'mosaic' (Duoblienè 2011: 10). Post-modern philosophical didactics trains the ability to think upon the world as an expression of different contexts; on the other hand, it gives the principle uniting multiplicity – the world as a secret (Jacques Derrida) and the world as becoming (Gilles Deleuze). The secret and the becoming are not metaphysical and ontological concepts but the limits towards which all the discourses converge. Neither philosophy, no morality or religion has access to this secret. "Somehow," writes Derrida, "this secret that we *speak* of but are unable to say is, paradoxically, like good sense in Descartes, the best-shared thing in the world; but it is the sharing of what is not shared: we know in common that we have nothing in common. There may be unlimited consensus on the subject, but the consensus is of no use, since it is a consensus on the fact that the singular is singular, that the other is other, that *tout autre est tout autre*" (Derrida Ferraris 2002: 59). All discourses (philosophical, literary, theological, etc.) are created as a response to this secret. Postmodern didactics is not looking for one privileged narrative, as an authority in comparison with the 'smaller' narratives. Thus the student acquires the status of the creator of any little narrative. The student is encouraged to create his own interpretation on philosophical insights by writing philosophical essays. The orientation of philosophical didactics towards text encourages the erudition of students and enlarges their capacities for creative writing, providing them with an intellectual background.

On the other hand, mainly in the framework of such a didactics, the possibility of the meeting between philosophical thinking and existential therapy arises. The aspects that at first seem unimportant and were considered in modern culture as marginal, from the post-modern point of view receive their own value. The criteria and hierarchy giving the more or less value to different phenomena of culture had disappeared for the reason that there is no centre as a point of departure for evaluation. For this reason, the unique student experience has its own independent value. Post-modern thinking does not discriminate as unimportant marginal groups those who lead alternative styles of living, the sexual and ethnic minorities. To George W. F. Hegel's European orientation, the post-modern approach opposes the equality of ethnic groups and civilizations rather distant from the formal world centre as Europe. As Linda Hutcheon notices, "postmodern art is always aware of difference, difference *within* any grouping too, difference defined by contextualization and positioning in relation to plural ones" (Hutcheon, 2000: 67). For this reason, post-modern philosophical didactics encourages students to trust in her/his own different experience and respect the other's unique difference.

Mainly the tolerance for this difference allows philosophical didactics to use a contemporary method of education – the case study. One on the branches of case studies is the writing of philosophical essays.

### **Creative Thinking and the Multiplicity of Ethical Experience in Post-modern Philosophical Ethics**

Modern philosophical ethics has a tendency to search for one concept as a priority (for John S. Mill it was happiness, for Immanuel Kant, duty), but post-modern philosophical ethics is based on the supposition that no one single concept can represent the variety and multiplicity of moral experience. This aspect is noticed even by analytic philosophical ethics. The British philosopher Bernard Williams in the book *Ethics and the Limits of Philosophy* (1993) notices: "If there is such a thing as the truth about the subject matter of ethics – the truth, we might say, about the ethical – why is there any expectation that it should be simple? In particular, why should it be conceptually simple, using only one or two ethical concepts, such as duty or good state of affairs, rather than many? Perhaps we need as many concepts to describe it as we find we need, and no fewer" (Williams 1993: 17).

Following a similar presumption, the *Reader of Philosophical Ethics for Forms 11–12* was prepared by Jūratė Baranova (1998, 1999, 2001). The course book is structured through the History of Concepts - Wisdom, Forgiveness, Duty, Suffering, Meaning of Life, Suicide, Responsibility, Freedom, Happiness, Love, Jealousy and Hatred, Woman and Man, Children and Parents, Friendship, and Loneliness. Each topic is structured through the change of the concept from Antiquity to the Philosophy of the twentieth century, keeping in mind that this number of concepts is arbitrary selected, and that the list could and should be enlarged by the students' own reflections upon their own moral experiences when creating new concepts and their own narratives. Currently, this textbook is being renewed and transformed into two new books: *Me and You. Form 10* and *Meaning and Freedom. Forms 11-12*.

The other step is the deconstruction of concepts as was suggested in Jacques Derrida's *Politics of Friendship* (1997). In this book Derrida reflects upon the concept of friendship from a different point of view. Starting from Aristotle's remark "O, my friends, there is no friend", quoted by Michel de Montaigne and Friedrich Nietzsche, Derrida by paradox of the phrase (one side of the sentence has plural friends, the other side has zero friends) reveals the different possible contradictions incorporated into the phenomenon of friendship. Reading Cicero, Seneca, Aristotle's ethics, philosophical philanthropy in Immanuel Kant's ethics, Friedrich Nietzsche's *Thus Spoke Zarathustra*, the works on the problem of Other in Emmanuel Levinas, and the opposition of friend and enemy in Carl Schmitt's political philosophy, Derrida asks questions which enlarge the understanding of the complexity of ethical experience. The point that Derrida brings to the initial paradox is that there is less friendship the more friends there are. Confronting Aristotle and Cicero, Derrida reveals that the logic of Aristotle's position is that the fewer the friends, the more the friendship, so that if I am my only friend that is the best friendship as there is no friend. The logic of Cicero's position is that I am my own best friend, because I am the best double of myself. The other questions raised by Derrida are: what is the connection between friendship and love, friendship and time, friendship and death, how is possible selectivity and universality in friendship? In this process of deconstruction, Derrida questions not friendship or morality, but the reduction of the complex phenomenon on morality to abstract concepts and the supposition that these clear concepts are able to represent the multiplicity of ethical experience, which is more close to the secret than to the concept. "*Il y a là du secret*", Derrida wrote (Derrida 1993: 57). "*Un geste « d'amitié » ou « de politesse » ne serait ni amical ni poli s'il obéissait purement et simplement à une règle rituelle*", he states in *Passions* (Derrida, 1993: 21): Instead of the ethics of rituals, principles and imperatives, he suggests the new ethics of deconstruction, based on non-decision (*l'inassurance*) and inexhaustible possibilities. This ethics avoids the classical clash between fact ("is") and norm ("ought") for the reason that the statement of fact "there is" and imperative of norm "ought to be" is changed to the word "maybe" (*«comme»*). The acknowledgement that there is no "duty" as a thing in itself or that there is no responsibility as a thing in itself does not mean that the discourse about the poly-semantic of these concepts does not provoke new reflections on moral experience. The ability of the students is to raise open questions and see the world as a permanent becoming of new questions.

Following similar suppositions, the other course-book *Philosophy* for forms 11-12 was also prepared and published by Jūrate Baranova and Tomas Sodeika in 2002. This textbook interweaves texts and images from philosophy, psychology, literature, paintings and movies. The textbook was republished as two new books: *Me and It. Forms 10-11* and *Philosophy: Man. Form 12*. As noticed by Darius Klibavičius (a philosophy teacher at a Jesuit gymnasium in Kaunas who for years used the textbook in lessons with students with good result, as his students participated not only in the national, but also international philosophy Olympiads with honorable mention awards and in the IPO 2014 received bronze medal), there is no common "bookish" truths in this textbook, and for this reason the teacher is obliged to become an active co-author of the textbook. The textbook trains the capacities of interpretive reading with the usage of the meditation of the written text. The meditation method is the input of Tomas Sodeika into philosophical didactics. "In discussion and disputes inevitably we are arguing and the problem becomes split up into parts in order to become clear to all the parts of discussion, but in meditation we do not discuss *pro* and *contra*, and the criteria of truthfulness are suspended, but the personal experience unites the meaning of pronounced word and in this inactivity brings it closer to students' life" (Klibavičius, 2003: 53). As Zenonas Norkus noticed, in writing a review on this textbook, "the uniting of philosophy, poetry, prose and visual art under one cover is an exact response to the Rorty's ideas and makes the book perhaps the most distinct phenomenon of post-modern literature in contemporary Lithuanian philosophical discourse" (Norkus, 2003: 186). But post-modern suppositions for training creative thinking in this textbook, as well as in the previously discussed one, are combined with a modernist principle of logical sequence. Klibavičius stated that, "although there is a large amount of texts, they are short and different; it is possible to group them very strictly according to topics. They are tastefully grouped, so it is possible to select them according to one's own opinion regardless of the right way previously stated for primacy. Here, as it suits to philosophical treatise, one can find more references, hints and encouragements than answers" (Klibavičius 2003: 54)

### The Interdisciplinary Approach and the Openness of Thinking in Post-modern Philosophical Didactics

One of the main features of post-modern philosophical didactics is that it focuses on the interdisciplinary openness of thinking. The methodological approach to the interdisciplinary aspect of philosophical didactics is Gilles Deleuze and Felix Guattari's experimental thinking. In the book *What is philosophy? (Qu'est-ce que la philosophie? 1991)* they write: "What defines thought in its three great forms – art, science, and philosophy – is always confronting chaos, laying out a plane,

throwing a plane over chaos. But philosophy wants to save the infinite by giving it consistency: it lays out a plane of immanence that, through the action of conceptual personage, takes events or consistent concepts to infinity. Science, on the other hand, relinquishes the infinite in order to gain reference: it lays out a plane of simply undefined coordinates that each time, through the action of partial observers, defines states of affairs, functions, or referential propositions. Art wants to create the finite that restores the infinite: it lays out a plane of composition that, in turn, through the action of aesthetic figures, bears monuments or composite sensations” (Deleuze Guattari 1994: 197). Every path they consider as unique. Three forms of thought could be seen as parallels and intersections, but they do not coincide and are not seen as synthesis. Deleuze and Guattari write: “Philosophy proceeds by sentences, but it is not always propositions that are extracted from sentences in general. At present we are relying only on a very general hypothesis: from sentences or their equivalent, philosophy extracts concepts (which must not be confused with general or abstract ideas), whereas science extracts prospects (propositions that must not be confused with judgments), and art extracts percepts and affects (which must not be confused with perceptions or feelings). In each case language is tested and used in incomparable ways—but in ways that do not define the difference between disciplines without also constituting their perpetual interbreeding” (Deleuze Guattari 1994: 24).

Philosophical passages of the abovementioned textbook *Reader of Philosophical Ethics* interweave poetry and prose with literature, including passages from the *New Testament*, and works of psychologists (Sigmund Freud, Erich Fromm). The topic starts with poetry, initiating an interpretative attitude, and finishes with the prose passage which allows the reader to find a certain relationship with the expression of this problem in everyday life. For example, “Jealousy and Hate” begins with Charles Baudelaire’s poem “Reversibility.” It is followed by excerpts from philosophers’ (Socrates, Aristotle, Plutarch, Francis Bacon, Bernard Mandeville, Claude Adrien Helvetius) on the meaning of these two concepts, then psychologists’ (Freud’s, Fromm’s) conceptions are discussed. Finally, the phenomenon is revealed by writer’s August Strindberg’s excerpt from his novel *The Confession of a Fool* and Andre Maurois’ insights about the ability of love to transcend the personal ego in his novel *The Climates of Love*. Each topic is composed by the same interdisciplinary interweaving of philosophy, science, and art, not only in this textbook, but also in the abovementioned *Philosophy* for forms 11-12.

All parts of the textbook are united by the means of a number of the questions which encourage both critical and creative thinking but all these extracts are united into one single consequent narrative. On the other hand, the boundaries of different spheres of culture are dissolved and the methods of post-modern didactics are taken into play. So it happens that this approach unites the modern and post-modern aspects of philosophical didactics in one single project.

Deleuze and Guattari say that the plane of composition of literature and the plane of the immanence of philosophy are able to penetrate into each other in such a manner that a part of one could be composed from the parts of the other. But they never create a synthesis. These parts nevertheless remain heterogeneous. The thinker is able to modify the thinking, include new images of thinking, and establish the new plane of immanence. The creation of concepts could be replaced by insights from poetry, novels, painting or musical works. But the movement in the opposite direction is also possible. Mainly in this “in-between”, in this clash of two modes of thinking – between philosophy and literature – the new expression of thought emerges.

### **The Interdisciplinary Approach and Creative Thinking: Philosophy and Visual Arts**

Post-modern philosophical didactics open the possibility for intersections not only between thought and image or concept and metaphor, but also the intersection of these two segments with the visual image as well. How can it be possible to use, for example, the paintings of Belgian surrealist René Magritte (1898-1967) in encouraging creativeness of philosophical thought? Magritte proposed an “optimistic” version of surrealism, based not on the unconsciousness or dreams but on the unexpected overturning of reality. His paintings are examples of plausible inversions of formal logic and ordinary meaning, leading in each case to a paradox. Magritte once said: “The sense of exactitude is no obstacle to a pleasure in in-exactitude”. Or again: “The language of authenticity ‘gives the word’ to words by making them say what they never said” (Meuris 1994: 123). Magritte in his painting posted the question of whether words really do have the meaning usually attributed to them in everyday usage. In the picture *The Key to Dreams* it is clearly recognizable that you are confronted with definitions which are, on the face of it, inappropriate. There is then clearly a desire to use pictures as a means of confusion where the received definitions are concerned. Magritte’s pictures were the subject of numerous philosophical

interpretations, especially by Michel Foucault. Following his essay *Les mots et les choses*, he wrote another entitled *Ceci n'est pas une pipe* (1973). Magritte responded to it with two letters. It is quite clear that the most obvious, and simplest, explanation lies in the observation that the picture of a pipe is nothing other than the representation of a smoker's accessory, and cannot itself be used for smoking. "But equally it throws the gates wide open to paradox an aporia (aporia being "a difficulty arising from an awareness of incompatible views on the same theoretic matter"). For the viewer of this painting, the object represented clearly is a pipe, no doubt about it. And why should this pipe not be a pipe? For the same reason that the word "dog" doesn't bark, as William James has observed <...>" (Meuris 1993: 129).

Being a painter, Magritte used to experiment with the established order of people's limited possibilities at the same time as if asking the main philosophical question stated by Kant "How would it be if...?" How would it be if the painter were able to paint the other person not only in the picture, but also in reality as well? (*Attempting the Impossible*, 1928). How would it be if the person, instead of only having two hands, were able to have four? (*The Magician*, 1952). How would it be if one's head would shine as if it were the sun? (*The Pleasure Principle: Portrait of Edwards James*, 1937). How would it be if one were able to observe the world not as one usually does, but with eyes in the back of the head? (*The Glass House*, 1939). How would it be if in lying near the sea one were to suddenly feel that a part of one's body is going to be a part of the fish? (*Collective invention*, 1934). How would it be if one's image in the mirror were reflected not as a face but as the back of one's head? (*Reproduction Prohibited: Portrait of Edward James*, 1937). The intellectual intrigue encoded into the plot of the picture could become an equivalent to the philosophical question and by this turn to become a visual possible means for encouraging flexible abstract thinking. When interpreting the pictures as puzzles created by Magritte in such a manner, it is possible to remember the thought expressed by Derrida in one of his interviews, when he said that it is important not only the events that happen to us but the events that never happened as well. Magritte it seems would have added: what are important also are the events that never could have had happen at all. By critically analyzing and reflecting upon this impossibility, students develop the ability to more deeply understand the aspects of possibility as such and to grasp the features of the real world.

How is it possible to include moving pictures as movies into the philosophy teaching curriculum? Since 2004 the program "Cinema in my school" provided in the Lithuanian schools has emphasized the cinema art more as a technological expression of moving image.

From the perspectives of post-modern didactics, cinema can be included into the curriculum as a means to training the critical as well as creative aspects of thought. Sometimes the movies could be used as an illustration of philosopher's lives, as, for example, *The Last Days of Immanuel Kant* by Philippe Collin and André Scala (1993), *Nietzsche's Days in Turin* (2001), by Júlio Bressane *Les Amants Du Flore* (2006) by Duran Cohen; or *Sartre, l'âge des passions* (2006) by Claude Goretta. Sometimes movies could be used as a visual illustration of certain philosophical novels such as Albert Camus's *Stranger* (1967), adapted to cinema by Lucino Visconti or Jean Paul Sartre's play *The Proud and the Beautiful* (1953) by Yves Allégret, *No Exit* (1953) by Jacqueline Audry or *The Condemned of Altona* (1962) by Vittorio De Sica. One of the productive usages is the case when a fictional movie or documentary were created as an encounter not only with the philosopher's life, but his conception as well, as, for example, what happened in *Wittgenstein* (1993) by Derek Jarman, or the documentary *Derrida* (2002) created by Kirkby Dick and Amy Ziering Kofman.

But does cinema have something to do with encouraging critical and creative thinking? Cinema in philosophical didactics can be used as a provocation for thought experiment.

Some philosophers state that movies are not an explicit illustration of philosophy, but they could encourage us to philosophize by suggesting thought experiments in the same manner as Plato suggested thought experiments in the allegory of the Rock. So it is possible to use the movie *The Matrix* by the Wachowski brothers as a possible thought experiment in comparison with Descartes skepticism. Goodenough notices: "This set of dark science-fiction fantasies provides a graphic illustration of a number of philosophical issues. Our hero, Neo, is awakened from his everyday life to discover that that life was in fact a computer programme; in reality, his body – together with those of almost all other human beings in the world – was being kept unconscious by the machines that have now taken over the world. The Matrix is a shared life-programme generated by the machines and fed to these bodies, giving them a consistent dream that they take to be everyday life. Such a film appeals to some long-standing philosophical problems; to the difference between appearance and reality, to questions of solipsism, of the nature of dreaming, and so on. It illustrates certain moves in Descartes' methodological skepticism in the Meditations, adapts Putnam's brain-in-a-vat case, and relates to Nozick's experience-machine" (Goodenough 2005: 2).



Jonas Dagys and Nerijus Milerius, Lithuanian philosophers from Vilnius University, created twelve videos titled *Classical and Contemporary Issues/Problems of Philosophy (Klasikinės ir šiuolaikinės filosofijos problemos)*, which could be used in teaching philosophy as an interdisciplinary subject for the reason that in this project philosophers, anesthetists, physicists, film directors, etc. , are discussing from their own perspectives the problems of existence, nature, goodness, beauty, language, daily life, time, freedom, consciousness, justice, truth and faith.

A turn in Modern Western philosophy towards the visualization made an impact on the didactic attitude of the Department of Philosophy at the Lithuanian University of Educational Sciences as well. References to films are introduced next to art reproductions. For example, in analyzing the topics "Person and Body," the film *The Double Life of Veronique (La double vie de Véronique)*, directed by Krzysztof Kieslowski, is suggested for consideration of the problem of personal identity from the open perspective of philosophers, writers and film makers.

What is the mission of cinema in comparison to other arts in training the students' thought experience? Russian director Sergej Eisenstein would had have said: in the path from the image to thought there is a shock or vibration, which must give rise to a thought in a thought; afterwards there is a movement from thought to image and some kind of internal monologue (rather than in a dream) capable of giving us a shock again. Antonin Artaud, although differently than Eisenstein, considers that what cinema advances is not the power of thought but its "impower", nevertheless considers the thought its main purpose. Deleuze, as if following Jean-Louis Schefer's idea, expressed in the book *Common man in cinema (L'homme ordinaire du cinema)*: "it is suspension of the world, rather than movement, which gives the visible to thought, not as its object, but as an act which is constantly arising and being revealed in thought : 'no that it is here a matter of thought become visible, the visible is affected and irremediably infected by the initial incoherence in thought, this inchoate quality" (Deleuze 1985: 161-162). Deleuze agrees with them say, "it is true that bad cinema (and sometimes good) limits itself to a dream state or imaginary participation. But the essence of cinema – which is not the majority of films – has thought as its higher purpose, nothing but thought and its functioning" (Deleuze 1985: 163).

## Conclusion

Critical and creative thinking are the aims of different sorts of philosophical didactics. Modern philosophical didactics emphasizes logical aspects of critical thinking and post-modernism uses the interdisciplinary and inter-textual approach to encourage creative thinking. Our conclusion is that these two didactics could work not necessarily in opposition but as complementary to each other for the following reasons:

- Both modern and post-modern philosophical didactics are orientated to one goal – to the training of the becoming of thought;

- Both modern and post-modern didactics emphasize the training of student reflectivity as a process and not a definite goal;

- Both modern and post-modern didactics are inclined to train cosmopolitan and civic society values;

Final conclusion: both modern and post-modern didactics differ by the utilized methods but not in the understanding of the content of education. Their possible coordination would have created a more poly-semantic field for the possible training of students' thinking.

## Literature:

Aškinytė, R. Degėsys, L. (2006) *Etika kaip loginio mąstymo teorija ir praktika Vadovėlis aukštųjų mokyklų studentams. (Ethics as a Theory and Practice of Logical Thinking. A textbook for the college students). II-asis pataisytas ir papildytas leidimas.* Vilnius: VPU leidykla.

Baranova, J. (2002) *Etika: filosofija kaip praktika. Mokytojo knyga (Ethics: Philosophy as a Practice. A Teacher's Book).* Vilnius: Tyto alba.

- Baranova, J. (2004a) *Filosofinė etika: Aš ir Tu. Vadovėlis 10 kl. (Philosophical Ethics: Me and You. A textbook for 10 form)*. Vilnius: Alma littera.
- Baranova, J. (2004b) *Filosofinė etika: prasmė ir laisvė. Vadovėlis 11-12 kl. (Philosophical Ethics: Meaning and Freedom. A textbook for 11-12 forms)*. Vilnius: Alma littera.
- Baranova, J. Sodeika, T. (2007a) *Filosofinė etika : Aš ir Tai. Vadovėlis 11 kl. (Philosophical Ethics: Me and That. A Textbook for 11 form)*. Vilnius: Tyto alba.
- Baranova, J. Sodeika, T. (2007b) *Filosofija : Žmogus. Vadovėlis 12 kl. (Philosophy: Man. A textbook for 12 form)*. Vilnius: Tyto alba.
- Baranova, J. (2009) *Filosofinės abejonės dėl mąstymo ir jausmų priešpriešos moralinio ugdymo procese (Philosophical Doubts on the Controversy Between Reason and Feeling in the Process of Moral Upbringing)*. *Acta Paedagogica Vilnensis*, no. 22, pp. 25-36.
- Baranova, J. (2012). *Kritinis mąstymas ir retorinė iškalbos ugdymas (The Role of Critical Thinking and Rhetorics in Upbringing)*. *Acta Paedagogica Vilnensia*, no. 28, pp. 96-106.
- Baranova, J. (2012) *Kino menas ir filosofinė edukacija: contra ir pro (Cinema and Philosophical Education: contra and pro)*. *Žmogus ir žodis*, no. 4, pp. 31-43.
- Degėsys, L. (2011) *Education as liberation of the self: principles and concepts of learning and teaching in the Pestalozzi Programme*. In *Teacher Education for Change. The theory behind The Council of Europe Pestalozzi Programme*. Strasbourg Cedex: Council of Europe Publishing, pp. 47-59.
- Degėsys, L. (2005) *Ethics as Theory and Practice of Logical Thinking*. In *Educational Systems Development as Development of Human Being*. Frankfurt am Main: Peter Lang. Europaisher Verlag der Wissenschaften, 2005, pp. 89-97.
- Degėsys, L. (2006) *La quotidianità come metafisica*. In *TransEuropaExpress. L'Europa alla prova del consenso*. Roma: Donzelli Editore, 2006.
- Deleuze, G. (1985) *Cinéma 2. l'Image-temps*. Paris: Les éditions de minuit.
- Deleuze, G. , Guattari, F. (1994) *What is Philosophy?* New York: Columbia University Press.
- Derrida, J. , Ferrari M. (2002) *A Taste for the Secret*. Cambridge, UK, Oxford UK, Malden USA: Polity Press.
- Derrida, J. (1997) *Passions*. Paris: éditions Galilée.
- Derrida, J. (2007) *Jacques Derrida. Basic Writings*. Ed. B. Stocker. London and New York: Routledge.
- Duoblienė, L. (2006) *Šiuolaikinė ugdymo filosofija: refleksijos ir dialogo link. (Contemporary Philosophy of Education: Towards Reflection and Dialogue)*. Vilnius: Tyto alba, 2006.
- Duoblienė, L. (2011) *Ideologizuotos švietimo kaitos teritorijos. (Ideological Territories of Educational Change )*. Vilnius: Vilniaus universiteto leidykla.
- Duoblienė, L. (2000) *Mąstymo ugdymas mokant filosofijos gimnazijoje (Teaching Philosophy in Secondary School: Formation of Thinking)*. . Daktaro disertacijos rankraštis. VU.
- Goodenough J. (2005) *Introduction I: A Philosopher Goes to the Cinema*. In *Film as Philosophy. Essays in Cinema After Wittgenstein and Cavell*. Houndmills and New York: Palgrave Macmillan, pp. 1-28.
- Filosofinės etikos chrestomatija, XI-XII kl. (Anthology of Philosophical Ethics for 11-12 forms)* Sud. J. Baranova. Vilnius: Alma littera, 2001.
- Hutcheon, L. (2000) *A Poetics of Postmodern History, Theory, Fiction*. New York, London: Routledge, 2000.
- Klibavičius, D. (2003) *Kaip skaityti filosofijos vadovėlių XI-XII klasėms? (How to Read the Textbook of Philosophy for 11 and 12 forms?)*. *Žmogus ir žodis*. 2003, no. 4, pp. 52-55.

---

Norkus, Z. (2003) *Naujos knygos besimokantiems filosofuoti (New Books for Learners to Philosophize)*. *Problemos*, t. 64, pp. 182-187.

Popper, K. R. (1992) *The Logic of Scientific Discovery*. London and New York: Routledge.

Sodeika, T. Baranova, J. (2002) *Filosofija. Vadovėlis 11-12 kl. (Philosophy)* Vilnius: Tyto alba.

Williams, B. (1993) *Ethics and the Limits of Philosophy*. Glasgow: Fontana press.

---

## Science Teachers Self Perception about Metacognition

**Mohammed Yousef Mai**

Faculty of Education, Universiti Pendidikan Sultan Idris

35900 Tanjung Malim, Perak Darul Ridzuan

dr. mohd. mai@gmail.com

### Abstract

*Metacognition is a significant part of human abilities. Metacognitive knowledge can be described as what we know about our own cognitive processes (Young & Fry, 2008). This research aims at measuring perception of science teachers about metacognitive awareness. The sample consists of 52 science teachers from six schools in Perak, Malaysia. Metacognitive awareness was measured using Metacognitive Awareness Inventory for Teachers (MAIT) developed by Cem Balcikanli (2011) that consists of 24 items, it has a good validity and reliability indicators. The results reveal that the science teachers have a high level of perception about metacognition. No significant differences found related to teachers gender or age. Although there are no significant differences found related to the teachers' gender, but there is a significant difference found related to the teachers' age and there is an interaction between teachers' age and educational level concerning their c.*

**Keywords:** Science teachers, Metacognitive, science education.

### Introduction

Metacognition is an important aspect of teaching and learning. It is one of the foundation upon which students may become independent learners (Fazal ur Rahman, 2011). In 1971, Flavell used the term metamemory in regard to an individual's ability to manage and monitor the input, storage, search and retrieval of the contents of his own memory. He implied with his statements that metacognition is intentional, conscious, foresighted, purposeful, and directed at accomplishing a goal or outcome. It is one's knowledge, concerning on one's own cognitive process and products or anything related to them. It is where a person is able to identify and aware of his cognitive process (Flavell, 1979).

The concept itself has increased its popularity in almost all disciplines ranging from communication to nursing. This popularity has been materialized with a lot of metacognitive inventories developed in time (Balcikanli, 2011). In the field of education, metacognition is congruent with the learners' need and desire to communicate, explain and justify thinking to organisms as well as to himself (Flavell, 1978). It is where the person needs to be able to identify his need to understand certain things in education and able to make others understand it too.

In research literature, there have been a great number of attempts to conceptualize the construct of metacognition over the last three decades. The literature is replete with definitions of meta- cognition up to date. However, there is no general consensus of the most agreed-upon definition of metacognition as yet (Balcikanli, 2011). "Metacognition" is often simply defined as "thinking about thinking" (Livingston, 1997). Others defined Metacognition as any knowledge or cognitive process, in which there are the assessment, monitoring or cognitive control. Based on a viewpoint, it can be considered as a general aspect of understanding which plays a role in all cognitive activities (Abdi et al. , 2012).

Metacognition is a multifaceted concept. This concept involves the knowledge (beliefs), processes and strategies which evaluate, supervises or control the identification (Abdi et al. , 2012). As the concept of metacognition includes that individual is aware of his own learning and learning process and can give feedback to himself regarding them, the individual should have these abilities. Metacognition takes part between cognition and emotion, plays a key role in self-regulation which is necessary for reaching success in learning and affects a lot of elements such as knowledge acquisition, comprehension, recollection and application (Alkan & Erdem, 2014).

Many researchers stress that metacognition is best defined by recognizing that it is both knowledge about, and control over, thinking processes. Therefore, metacognition could be considered as a three-step process (Fazal ur Rahman, 2011):

- (1) Connecting new information to previous knowledge
- (2) Deliberately selecting thinking strategies
- (3) Planning, monitoring, and evaluating the thinking processes

The purpose of metacognitive prompting is to guide learners in the process of identifying the structure of problems, creating connections with prior knowledge, and selecting learning strategies. It is meant to promote learners' regulation of their knowledge and skills during training rather than awareness of performance alone (Aurah, Cassady, & McConnell, 2014). Fazal ur Rahman (2011) also reported that Hennessey (1999), identified five characteristics of metacognition:

- (1) A knowledge of the content of own thinking.
- (2) An awareness of own conception.
- (3) Monitoring of own cognitive process
- (4) Regulation of one's cognitive processes with respect to further learning.
- (5) An application of a set of heuristics for helping people organizes their method to solve problems.

Similarly, Hartman (2001) underlined the following points of metacognition:

- (1) Metacognition is thinking about thinking.
- (2) It enables awareness and control over how teachers think about teaching.
- (3) It enables them to self-regulate teaching activities with respect to students, goals and situation.
- (4) Some metacognition is domain-specific and some are domain-general
- (5) Two general types of metacognition are: executive management strategies that help to plan, monitor and evaluate/revise thinking processes and products, and strategic knowledge about information/strategies/ skills and when, why and how to use them.

The term "metacognition" is most often associated with John Flavell (Livingston, 1997), he often considered being the father of metacognition. He viewed metacognition as a primarily conscious endeavor; however, he also acknowledged that it may well take place unconsciously. Flavell proposed a formal model of metacognitive monitoring to include four classes of phenomena and their relationships. His four- pronged model of metacognition breaks down into the following categories (Flavell, 1979) (Fouché, 2013):

1. Metacognitive knowledge, which he defined as one's knowledge or beliefs about the factors that affect cognitive activities. The distinction between cognitive and metacognitive knowledge may lie in how the information is used, more than a fundamental difference in processes. Metacognitive activity usually precedes and follows cognitive activity. They are closely interrelated and mutually dependent. Metacognitive knowledge can lead the individual to engage in or abandon a particular cognitive enterprise based on its relationship to his interests, abilities and goals.
2. Metacognitive experiences, it includes the subjective internal responses of an individual to his own metacognitive knowledge, goals, or strategies. Metacognitive experience can also be a "stream of consciousness" process in which other information, memories, or earlier experiences may be recalled as resources in the process of solving a current-moment cognitive problem.
3. Metacognitive goals and tasks are the desired outcomes or objectives of a cognitive venture. This was Flavell's third major category. Goals and tasks include comprehension, committing facts to memory, or producing something, such as a written document or an answer to a math problem, or of simply improving one's knowledge about something. Achievement of a goal draws heavily on both metacognitive knowledge and metacognitive experience for its successful completion (Flavell, 1979).
4. Metacognitive strategies are designed to monitor cognitive progress. Metacognitive strategies are ordered processes used to control one's own cognitive activities and to ensure that a cognitive goal (for example, solving a math problem, writing an effective sentence, understanding reading material) have been met. A person with good metacognitive skills and awareness uses these processes to oversee his own learning process, plan and monitor ongoing cognitive activities, and to compare cognitive outcomes with internal or external standards.

Researchers further conceptualize metacognition by breaking down metacognition into two subcomponents, metacognitive knowledge (knowledge about cognition) and metacognitive regulation (regulation of cognition). These two subcomponents have been theorized to be related to one another, Metacognitive knowledge can be described as what we know about our

own cognitive processes. In the category of metacognitive knowledge, researchers suggested subcategories of (Balcikanli, 2011) (Young & Fry, 2008):

- Declarative knowledge, In brief, declarative knowledge refers to “knowing about things”
- Procedural knowledge, procedural knowledge refers to “knowing how to do things”, and
- Conditional knowledge. , Conditional knowledge is “knowing the why and when aspects of cognition”.

As a whole, our knowledge of cognition refers to what we know about how we learn; what we know about the procedures and strategies that are the most effective for us; and, what we know about the conditions under which various cognitive activities are most effective.

In contrast to metacognitive knowledge, metacognitive regulation is more related to a set of actions and events so as to facilitate learning than a set of knowledge that shapes how those actions emerge. Metacognitive regulation can be broken down into three component activities. These include:

- Planning involves “the selection of appropriate strategies and the allocation of resources that affect one’s learning performance”.
- Monitoring involves “one’s on-line awareness of comprehension and task performance”.
- Evaluating refers to “appraising the products and regulatory processes of one’s learning”.

Flavell (1979) pinpointed three important implications for this. First, metacognitive experiences have the power of influencing metacognitive knowledge along with a variety of actions including adding, deleting or revising. Second, they can guide learners to recreate new goals and revise them on the basis of old ones. Third, metacognitive experiences can arouse strategies that may be employed in the face of cognitive or metacognitive goals (Balcikanli, 2011).

It stands to reason that if students have well developed metacognitive knowledge and metacognitive regulatory skills and they use their metacognition, they will excel academically (Young & Fry, 2008).

Metacognitive awareness is an important element in learning, it plays a pivotal role in the effectiveness of the learning process, it could be defined as ability of individuals to control his own cognitive process and direct them (Alkan & Erdem, 2014). Studies suggest that metacognition has the potential to affect students’ learning across different domains. Flavell emphasized that “metacognition is congruent with the learners” need and desire to communicate, explain and justify thinking to organisms as well as to himself” (Balcikanli, 2011). He acknowledged the significance of metacognition in a wide range of applications that included reading, oral skills, writing, language acquisition, memory, attention, social interactions, self-instruction, personality development and education (Flavell, 1979).

So far, the correlation between the metacognitive beliefs and students’ academic achievement has been studied in a very limited research, but it seems that the metacognitive beliefs have an important impact on the students’ academic achievement (Abdi et al. , 2012). Young & Fry (2008), based on their research study where they investigated to reveal the relationship between metacognitive awareness and academic achievement in college students, found out that there are correlations between the MAI (Metacognitive Awareness Inventory) and cumulative GPA (Grade Point Average).

Lee (2009) examined the relationships between metacognition, self-regulation and students’ critical thinking skills and disposition, she argued that self-regulation had significant relationships with students’ critical thinking disposition (Balcikanli, 2011)

Furthermore, metacognition has been one of the most concentrated concepts among researches because of many reasons (Memnun & Akkaya, 2009):

1. Metacognition is one of the most important factors that affect problem solving behaviors of individuals
2. Metacognition is an extremely important structure, affecting individual learning process
3. Metacognition has a main role in the self-regulation, required to succeed in learning
4. Learners with a certain level of self-regulation and strategy of metacognition get a better academic achievement.
5. Metacognition encourages reflective thinking, provide responsibility, and build self-confidence to make decisions quickly.
6. Metacognition facilitates critical and creative thinking.

Thus, metacognition is important to regulate and improve their cognitive tactics and strategies used in problem solving process. The students with a higher level of metacognitive skills become successful in problem solving (Aurah et al. , 2014).

When students are aware of their learning process they will be able to focus and study better. On the other hand, teachers who are aware of their teaching process and well aware of the students' conditions will be able to have a better control in the learning process.

As certain studies indicate, metacognition is a crucial skill to have since it makes students independent thinkers who control their thinking processes. Using metacognition, learners can have the control over what and how they learn, which can trigger the development of independent learning. What is important is that learners who display more metacognitive skills tend to set clear objectives in the learning process, to define the content, to make a schedule in line with this content, and to select the cognitive and metacognitive strategies. (Balcikanli, 2011).

Various studies have revealed that learning can be enhanced if students use metacognitive processes, i. e. ; they are aware of, monitor and control their own learning. Good learners are metacognitively adept and poor ones metacognitively deficient in how they tackle learning tasks in most subjects (Fazal ur Rahman, 2011).

If it is the aim of education to let learners take charge of their own learning, then they need to be able to plan, monitor and evaluate their learning. In order to do so, they need to be metacognitively aware, students without metacognitive approaches are essentially learners without direction and ability to review their progress, accomplishments and future learning directions (Balcikanli, 2011).

Metacognition plays an important role in teaching, learning, social cognition, attention, self-discipline, problem solving, communication and personality development. An understanding of learning process and learners, will put the teacher in a better position to decide what can be done and how, what will not work and why (Fazal ur Rahman, 2011).

Metacognitive teaching refers teaching with and for metacognition. It means teachers think about their own thinking regarding instructional goals, teaching strategies, sequence, materials, students' characteristics and needs, and issues related to curriculum, instruction and assessment before, during and after lessons. Teaching for metacognition means teachers think about how teaching will activate and develop students' metacognition, or thinking about their own thinking as learners (Fazal ur Rahman, 2011).

Metacognition is important for teachers as they need to handle the students as well as adapting it to the students. In school environment, teachers need to socially interact with their students, colleagues, and as well as parents. This is where teachers need to adapt with suitable metacognition in order for them to deal with each people differently. In contrast to the problems and tasks confronted in typical metacognitive interventions, teachers must find a way to effectively communicate and interact with people of different values to make their adaptations successful (Lin, Schwartz, & Hatano, 2005). Metacognition in science teaching and learning includes both aspects teaching for and with metacognition (Hartman, 2001):

1. Metacognition enables teachers to regulate their teaching activities according to students, goals and situation.
2. It help the teachers to plan, monitor and evaluate thinking processes and products, and
3. It also equip the teachers about what information/skills they have, when, why and how to use them.

Teachers need to think metacognitively to effectively run teaching and use instructional techniques strategically. According to the literature on metacognition theory teachers' understanding of metacognition is complex and depends on an interaction between declarative, procedural, and conditional knowledge. The metacognition theory assumes that teachers' conditional knowledge influences procedural knowledge, which in turn also affects declarative knowledge, and further alters their pedagogical knowledge in metacognition. Procedural knowledge directly affects declarative knowledge and pedagogical knowledge. Declarative knowledge builds upon conditional and procedural knowledge and directly influences pedagogical knowledge (Wilson & Bai, 2010).

Teaching is a profession where teachers or educators need to engage with a variety and diversity of students. Thus, it makes the teaching profession as one of the most challenging profession. In everyday teaching lesson, teachers need to be able to vary their teaching methods as well as lesson in order to attract the students' attention. The teaching process will become harder once the teachers have to deal with different level of students in the classroom. This is where

---

metacognition is important for teachers to be adapted in their teaching. It is because “successful teaching can benefit from what we call adaptive metacognition, which involves change to oneself and to one’s environment, in response to a wide range of classroom social and instructional variability profession”

(Lin et al. , 2005).

There are many problems regarding the issue of teaching. However, when it comes to problems or students’ low performance, teachers are among the first people that will be questioned. One of the major problem faced by the pre-service teachers is the ability to view the importance of seeing different educational theories related to real instructional problems. Teachers play the important role in educating and as well as to teach the students. Teachers need to know their strength and weaknesses in teaching and always try to improve them. It is highly believed that knowing what teachers know about their own teaching should be a starting point for a change in teacher development (Balcikanli, 2011).

Therefore, metacognitive awareness of teachers is regarded as an important factor in increasing of their career’s success, their creative and critical thinking, and building self-confidence. Consequently, it has very critical importance to determine the level of metacognitive awareness of teacher. The aim of this study is to determine the levels of metacognitive awareness of primary science teacher, and examine whether these levels change according to some variables such as gender or class levels.

### Research questions

A detailed study of teachers’ pedagogical understandings of metacognition requires that teachers have declarative, procedural, and conditional knowledge. Declarative knowledge is a teachers’ knowledge of what they should teach. Procedural knowledge is knowledge of how a teacher teaches something. Conditional knowledge is the understanding that the teaching of metacognitive strategies is dependent on the situation and that particular situations require the use of particular strategies.

The research questions under investigation for this study are as follows:

1. What are the science teachers' perception about metacognitive awareness?
2. Is there a significant difference among scores of metacognitive awareness of science teachers according to their gender, age and educational level?
- 3.

### Method

#### Participants

The sample of this research consists of 52 primary school science teachers in Ipoh-Malaysia. Around 40% of them are males and 60% are females. 71% of male teachers are 41-40 years old, while 45% of female teachers are 31-40 years old. The majority of the sample (78. 8%) has bachelor (66. 7% of males and 87. 1% of female teachers. See table 1.

#### Materials

This study intends to investigate teachers’ metacognitive awareness in teaching. In this study, the researcher adapted an inventory Metacognitive Awareness Inventory for Teachers (MAIT) by Balcikanli (2011). This inventory comprises of two aspects that are metacognitive knowledge and metacognitive regulation. In metacognitive knowledge, there are three strategies that completed it. It consists of the strategies of declarative knowledge, procedural knowledge and conditional knowledge. Meanwhile, in metacognitive regulation, there are three strategies included in this part that are planning, monitoring and evaluating. It includes two parts. Part one contains demographic questions. Part two is the Teachers’ Metacognition Scale (TMS) with 24 Likert- Scale questions.



The inventory was modified to a 5 point Likert- Scale ranging from (1) "strongly disagree" to (5) "strongly agree". There are six sub-items in the inventory that can be divided into two aspects, which are metacognitive knowledge and metacognitive regulation. In metacognitive knowledge, there are three sub categories are, declarative knowledge, procedural knowledge and conditional knowledge. In metacognitive regulation, the three-sub cognition are, planning, monitoring and evaluating. In the inventory, in the six subs cognition in metacognitive knowledge and metacognitive regulation there were four items each developed from them. Thus, the four items in the six subs cognition was sum up to 24 items that were designed for the inventory.

Since the instrument has not been used in the Malaysian cultural background before, the researcher retest the reliability using Cronbach's Alpha internal consistency coefficient and split-half coefficient. The results of Cronbach's Alpha internal consistency coefficient for the scale indicate that the overall scale had an alpha of 0. 880 and 0. 852 of split-half coefficient. This means that the instrument has a good reliability and can be used to measure the science teachers' perceptions about metacognition.

## Results

The main aim of this study is to measure science teachers' perceptions about metacognition. Also, if there are a significant difference among scores of metacognitive awareness of science teachers according to their gender, age and educational level.

### Findings of descriptive Analyses

The second section of the survey asked science teachers to report their perceptions about metacognition. Table (2) includes the means and standard deviations about teachers perceptions about metacognition. The results show that science teachers have good perceptions about metacognitionis (M = 96. 15, SD = 6. 26) with 80% of mean. All the 6 sub categories nearly get 80% of mean. The mean ranged from 15. 8-16. 15 with standard deviation between 1. 08 to 1. 3. Those results reveal that science teachers have a good perception about knowledge and regulation of metacognition.

For more details, results in table (3) showed that the lowest items in knowledge of metacognition are items 11 and 11 with 76-78% of mean, those items are about (I find myself assessing how useful my teaching techniques are while I am teaching, and I ask myself if I could have used different techniques after each teaching experience). Both of them are about the usefulness of the techniques and the possibility of using different techniques. On the other hand, the highest items are 8, 2, 10 respectively. Those items got percent of mean ranged from 53-86%, they are about reasons for choosing each teaching technique, using teaching techniques that worked in the past, and setting teaching goals before start teaching.

With regard to the other part "regulation of metacognition", the lowest items are 20 and 21 with percent of mean between 69-75%. Those items are about "using helpful teaching techniques and effective teaching technique". The highest items with percent of mean around 82% are items number 15, 18, 19, and 22. The highest items are about using different teaching techniques, teach in more effective way next time, knowing what expected to teach and organizing teaching time.

In general, these results indicate that science teachers have good perceptions about metacognitionis. They are aware about reasons for choosing each teaching technique, using teaching techniques that worked in the past, and setting teaching goals before start teaching. They also think about using different teaching techniques, teach in more effective way next time, knowing what expected to teach and organizing teaching time.

### Findings of multivariate Analysis

Are there any significant difference among scores of metacognitive awareness of science teachers according to their gender, age and educational level? Considering the different perceptions between teachers according to their gender, age and educational level, and testing the interaction between the independent variables, the researcher used a multivariate analysis, the results included in table 4.

Table 4 shows the main 3-way ANOVA summary results. The main effect of gender was not significant,  $F(1, 41) = 0.289$ ,  $p = .594$ . While, the main effect of educational level was significant,  $F(1, 41) = 12.141$ ,  $p = .001$  and the main effect of age was also significant,  $F(2, 41) = 6.757$ ,  $p = .003$ . Regarding the interaction between the independent variables, it was not significant for Gender \* Educational level,  $F(2, 41) = 0.771$ ,  $p = 0.385$ , and Gender \* Age,  $F(2, 41) = 0.497$ ,  $p = 0.612$ , and Gender \* Educational level \* Age,  $F(2, 41) = 0.078$ ,  $p = 0.782$ . However, the interaction effect between Educational level \* Age was significant,  $F(2, 41) = 17.524$ ,  $p = 0.001$ . The plot of the mean "perceptions about metacognition" score for each combination of groups of "Educational level" and "Age" is plotted in a line graph, as shown in figure 1, and the results of the Multiple Comparisons (Scheffe test) presented in table (5).

Figure 1 shows that the teacher age interacted with their educational level to explain their perception of metacognition. The teachers aged 20-30 with diploma have higher perception than teachers aged 20-30 with bachelor. This result is the same as for teachers aged 41 years old and above with bachelor degree. On the opposite, the teachers aged 31-40 with bachelor have higher perception than teachers aged 31-40 with diploma have.

The results of the Multiple Comparisons (Scheffe test) presented in table (5) showed that there is a significant difference between teachers according to their age. Teachers aged 20-30 have higher perception towards metacognition than both of teachers aged 31-40 and teachers aged 41 years old and above do.

## Conclusion

Metacognitive is a term that is widely discussed in the field of education. However, there is only little research in this issue happened in Malaysia. There are many literature reviews from Flavell (1971) until Balcikanli (2011) that studies on metacognition. It shows that metacognition plays a very important role in education. It does not only work for the students but it helps the teachers to improve their teaching skills. Many researches show that students that are able to be aware of the metacognitive have a better opportunity in learning compared to those who do not. In relation to teaching, it is important for teachers to be able to measure their level of awareness in metacognitive knowledge and regulation in order for them to apply and eventually teach the right metacognitive knowledge and regulation that best suits their students.

Lastly, Metacognitive Awareness Inventory for Teachers (MAIT) is used in order to see the effectiveness of this inventory towards the primary school science teachers in Ipoh. Results indicated that science teachers have good perceptions about metacognition. They are aware about choosing the appropriate and effective teaching technique, and setting teaching goals before start teaching. And they also think about using different teaching techniques and organizing teaching time. The results of the multivariate analysis showed the interaction effect between Educational level \* Age, the teachers aged 20-30 with diploma have higher perception than teachers aged 20-30 with bachelor. On the opposite, the teachers aged 31-40 with bachelor have higher perception than teachers aged 31-40 with diploma have. Regarding the teachers age, teachers aged 20-30 have higher perception towards metacognition than both of teachers aged 31-40 and teachers aged 41 years old and above do.

## References

- Abdi, H. M., Bageri, S., Shoghi, S., Hosseinzadeh, A., Branch, R., & Branch, S. (2012). The Role of Metacognitive and Self-Efficacy Beliefs in Students' Test Anxiety and Academic Achievement, *6* (12), 418–422.
- Alkan, F., & Erdem, E. (2014). The Relationship between Metacognitive Awareness, Teacher Self-efficacy and Chemistry Competency Perceptions. *Procedia - Social and Behavioral Sciences*, *143*, 778–783. doi: 10.1016/j.sbspro.2014.07.475
- Aurah, C. M., Cassady, J. C., & McConnell, T. J. (2014). Predicting Problem Solving Ability from Metacognition and Self-Efficacy Beliefs on a Cross Validated Sample. *British Journal of Education*, *2* (1), 49–72. Retrieved from <http://www.eajournals.org/journals/british-journal-of-education-bje/vol-2-issue-1march-2013/predicting-problem-solving-ability-metacognition-self-efficacy-beliefs-cross-validated-sample-2/>
- Balcikanli, C. (2011). Metacognitive awareness inventory for teachers (MAIT). *Electronic Journal of Research in Educational Psychology*, *9* (25), 1309–1332.

Fazal ur Rahman. (2011). *Assessment of Science Teachers Metacognitive Awareness and Its Impact on the Performance of Science Teachers Metacognitive Awareness and Its Impact on the Performance of STUDENTS*. ALLAMA IQBAL OPEN UNIVERSITY.

Flavell, J. (1979). Metacognition and cognitive monitoring: a new area of cognitive developmental inquiry. *American Psychologist*, 34 (10), 906–917.

Fouché, J. (2013). *THE EFFECT OF SELF-REGULATORY AND METACOGNITIVE STRATEGY INSTRUCTION ON IMPOVERISHED STUDENTS' ASSESSMENT ACHIEVEMENT IN PHYSICS*. Liberty University.

Hartman, H. E. (2001). *Metacognition in learning and instruction: Theory, research and practice*. Netherland: Kluwer Academic.

Lee, S. (2009). *Examining the relationships between metacognition, self-regulation and critical thinking in online socratic seminars for high school social studies students*. Unpublished Master's. University of Texas.

Lin, X. , Schwartz, D. L. , & Hatano, G. (2005). Toward Teachers' Adaptive Metacognition. *Educational Psychologist*, 40 (4), 245–255. doi: 10. 1207/s15326985ep4004\_6

Livingston, J. A. (1997). Metacognition: An Overview. *The American Journal of Pharmacy Education*, (1). Retrieved from <http://www.ncbi.nlm.nih.gov/pmc/articles/PMC1847545/>

Memnun, D. S. , & Akkaya, R. (2009). The levels of metacognitive awareness of primary teacher trainees. *Procedia - Social and Behavioral Sciences*, 1 (1), 1919–1923. doi: 10. 1016/j. sbspro. 2009. 01. 337

Wilson, N. S. , & Bai, H. (2010). The relationships and impact of teachers' metacognitive knowledge and pedagogical understandings of metacognition. *Metacognition and Learning*, 5, 269–288. doi: 10. 1007/s11409-010-9062-4

Young, A. , & Fry, J. D. (2008). Metacognitive awareness and academic achievement in medical students. *Journal of the Scholarship of Teaching and Learning*, 8 (2), 1–10. doi: 10. 3109/0142159X. 2010. 487711

## Tables

Table 1. The sample

	Male	Male	Female	Female	Total	
	Count	%	Count	%	Count	%
20 - 30 years	5	23. 8%	5	16. 1%	10	19. 2%
31 - 40 years	15	71. 4%	14	45. 2%	29	55. 8%
41 and above	1	4. 8%	12	38. 7%	13	25. 0%
Diploma	7	33. 3%	4	12. 9%	11	21. 2%
Ijazah	14	66. 7%	27	87. 1%	41	78. 8%
	21	40. 4%	31	59. 6%	52	100. 0%

Table 2. The mean and Std. Dev. about teachers Perception of metacognition (N=52)

Mean                      Std. Deviation

declarative knowledge	16. 1538	81%	1. 30436
procedural knowledge	15. 9423	80%	1. 30479
Conditional knowledge	16. 0385	80%	1. 11955
planning	16. 2115	81%	1. 39096
monitoring	15. 8077	79%	1. 48243
evaluating	16. 0000	80%	1. 08465
Metacognition	96. 1538	80%	6. 29467

Table 3. The mean and Std. Dev. about teachers Perception of metacognition (N=52)

	Mean	%	Std. Deviation
1. I am aware of the strengths and weaknesses in my teaching.	4. 019	80%	0. 420
2. I try to use teaching techniques that worked in the past.	4. 212	84%	0. 498
3. I use my strengths to compensate for my weaknesses in my teaching.	4. 154	83%	0. 460
4. I pace myself while I am teaching in order to have enough time.	3. 981	80%	0. 577
5. I ask myself periodically if I meet my teaching goals while I am teaching.	4. 038	81%	0. 593
6. I ask myself how well I have accomplished my teaching goals once I am finished.	4. 135	83%	0. 715
7. I know what skills are most important in order to be a good teacher.	4. 019	80%	0. 610
8. I have a specific reason for choosing each teaching technique I use in class.	4. 308	86%	0. 466
9. I can motivate myself to teach when I really need to teach.	4. 019	80%	0. 610
10. I set my specific teaching goals before I start teaching.	4. 173	83%	0. 474
11. I find myself assessing how useful my teaching techniques are while I am teaching.	3. 885	78%	0. 615
12. I ask myself if I could have used different techniques after each teaching session.	3. 808	76%	0. 525
13. I have control over how well I teach.	3. 981	80%	0. 505
14. I am aware of what teaching techniques I use while I am teaching.	3. 981	80%	0. 542
15. I use different teaching techniques depending on the situation.	4. 096	82%	0. 358
16. I ask myself questions about the teaching materials I am going to use.	3. 942	79%	0. 366
17. I check regularly to what extent my students comprehend the topic while I am teaching.	3. 904	78%	0. 534

18. After teaching a point, I ask myself if I'd teach it more effectively next time.	4. 096	82%	0. 534
19. I know what I am expected to teach.	4. 135	83%	0. 444
20. I use helpful teaching techniques automatically.	3. 442	69%	0. 574
21. I know when each teaching technique I use will be most effective.	3. 769	75%	0. 425
22. I organize my time to best accomplish my teaching goals.	4. 115	82%	0. 471
23. I ask myself questions about how well I am doing while I am teaching.	3. 981	80%	0. 420
24. I ask myself if I have considered all possible techniques after teaching a point.	3. 962	79%	0. 194

Table 4: Tests of Between-Subjects Effects

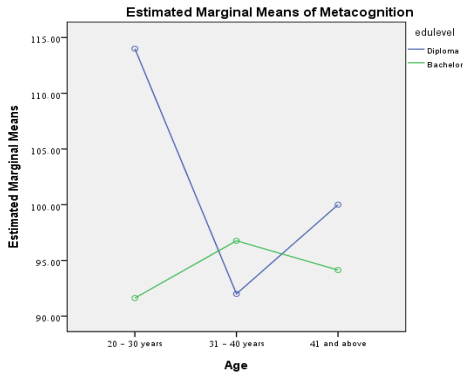
Source	Type III Sum of Squares	df	Mean Square	F	Sig.
Corrected Model	994. 032a	10	99. 403	3. 969	. 001
Intercept	164294. 253	1	164294. 253	6560. 650	. 000
Gender	7. 240	1	7. 240	. 289	. 594
Educational level	304. 038	1	304. 038	12. 141	. 001
Age	338. 428	2	169. 214	6. 757	. 003
Gender * Educational level	19. 307	1	19. 307	. 771	. 385
Gender * Age	24. 867	2	12. 434	. 497	. 612
Educational level * Age	877. 665	2	438. 833	17. 524	. 000
Gender * Educational level * Age	1. 943	1	1. 943	. 078	. 782
Error	1026. 737	41	25. 042		
Total	482790. 000	52			
Corrected Total	2020. 769	51			

a. R Squared = . 492 (Adjusted R Squared = . 368)

Table 5: the results of the Multiple Comparisons (Scheffe test)

(I) Age		Mean Difference (I-J)	Sig.
20 - 30 years	31 - 40 years	8. 431*	. 001
	41 and above	6. 722*,b	. 037
31 - 40 years	20 - 30 years	-8. 431*	. 001
	41 and above	-1. 709b	. 527
41 and above	20 - 30 years	-6. 722*,c	. 037
	31 - 40 years	1. 709c	. 527

Figure 1: mean of perceptions about metacognitionis for each combination of groups



---

## Organizing of Physical Education Teaching Classes and Methods to be Used to Achieve the Intended Objectives

Rovena Elmazi

Ledina Koci

rd.elmazi@gmail.com

Mob: 00355695131350

### Abstract

*Physical education is an integral part of the comprehensive education of pupils. It represents the whole of the methods that aim to improve the psycho-motor qualities of them. Physical education and education are closely related to each other. Encouraging and promoting children to work with desire and seriously begin since preschool age and later at school. For this reason in the content of the preschool cycle program, different games should prevail, led by the teacher who seek not only fun but also develop pupils' motor skills. Physical education teachers have an important role in this development process. They must commit to implementing the program quality, well recognize how its content should be performed, the load to be taken and in particular anatomic physiological progress, the psyche progress and the motor progress that delivers every motor activity conducted within the classroom. Physical education teacher in his work looks to each student's level of motor skills formation as one of the basic requirements contained in the program. He must identify the anthropometric indicators, physical attributes and motor skills of the students and on the basis of these indicators will organize and differentiated work. First of all differential work is strongly supported in the motor skills level, to continue with the advanced elements by adapting the physical possibilities of the pupils. Teachers must have a special attention to the terminology used in order to be as clear and comprehensible his instructions to them.*

**Keywords:** Physical Education, program, method, terminology, psycho-motor qualities, motile

### Introduction

The academic teaching process of physical education applies general didactic principles which apply to other subjects as well including systematic learning, learning adaptation based on mental and physical capacity and student-developed classes. Learning in the process of physical education has a significant educational nature especially from the social aspect. Consequently, the teacher must not separate the acquisition of movements, development of physical qualities, anthropometrical qualities and agility from education of moral and ethical values of the students. Any didactic analysis of physical education must be anticipated by the structural analysis and physical and sports exercise which inter alia consists in the study of the elementary movements, substance of the physical exercises and their learning. Moreover, it would be more important to know the position of physical education in the school.

### Aim of study/research

The aim of this study is to become acquainted with the teaching methods in the physical education classes and select the proper methods for organisation of the teaching classes in order to achieve the intended objectives. Throughout my experience as a teacher of physical education I have concluded that the choice of the proper method plays a very important role in the quality of the classes. The methods consist in the set of means and way of teaching based on which the student, under the guidance of the teacher try to acquire knowledge, agility, movement expression on the one side and attain the objective of their education in general on the other side. There are three methods to organise physical education classes: 1- demonstration method, 2- verbal method and 3- exercise method. Such methods must be selected by the teacher based on the age, knowledge of the students about the topics and their physical skills. Each of the methods has its own specifics.

### Research topic

---

The reason for this research is built upon the mission we have to forward the message that sports is the key to the psycho-motor development of the children. As a teacher of physical education, I have come to the conclusion that the better the organisation of the classes by the teacher, the better are the results of the development of the students. It is to this end that we decided to make this research to show that the method chosen to transmit knowledge to the student is the most important step which must never be undermined.

### **Research question**

The main research question is: what is the proper method to be used during the physical education classes in order to attain the required objectives? Before elaborating on this question, first we must know which are the methods and their specifics, and whether they are closely linked to the age-group of students. Such questions shall be answered in the following sections.

### **Scientific methods**

The methods used for this study are examination of the students in public and non-public schools in Tirana during the physical education classes. It all started with the children of the pre-school system and depending on the topic of the day we have used three methods to conclude which is the most relevant method to make the topic easily understood and applied. We applied the same method to the students starting from the first to the fifth grade. Concerning the students of the sixth to the ninth grade we initially tested their theoretical knowledge on the subject and then we used the methods and concluded on the most appropriate method to have qualitative teaching and learning classes.

### **Discussion**

The physical education subject and participation in various sports activities plays a very important role in the psycho-motor development. The school must not transmit knowledge alone. In addition it must affect the education of their skills. Children, before going to school, learn with all their senses and improve quickly their mistakes, therefore learning at a clearly defined pace very often seems tiring wearisome. If we want children to be more motivated for this teaching class, we must clearly explain them why it is necessary to attend the physical education classes and their usefulness. Employing various games, especially those in the form of races through which the students experience positive emotions, is essential in feeding their motivation for the physical education class.

Physical education is integral part of their comprehensive education. It constitutes the set of methods which aim at improving the psycho-motor skills of students. It has to be reemphasised to the students of the elementary cycle that they must be able to run, swim, be disciplined, persistent, daring, qualities which help them grow strong. To this end, special attention must be paid to this area, especially during the work of the physical education teachers. In their capacity, they must work with both seriousness and will.

In order to succeed in their work, the teachers must be willing and devoted in implementing the academic programme, which aims at the psycho-motor development of the children. It consists of several movement activities which are performed successfully through the better organisation of students during the teaching classes and proper use of methods in order to make it as simple and understandable for the student.

It is up to the teacher to prepare, before organising the classes, the place where the class will be delivered and use the means to the employed for the topic in question. The forms of organising the classes must guarantee effectiveness in the ability to acquire movement expressions. The teacher must be cautious in the choice of terminology, which must be clear and simple, so as to be as understandable as possible by the student.

The methods of delivery of classes consist in the set of methods used by the teachers during the classes in order to make the exercise as clear to the student. The use of one method or the other depends on the skills of the teacher, the content of the teaching classes, the individual features of the students, materials etc. They are not rigid but they are adapted to the



topic of the teaching classes very often and referring to the absorption by the student, the methods of the physical education are divided in the three main groups:

#### 1- Demonstration method

Demonstration must present the technique of movements in a perfect and dynamic manner. The teacher explains the exercise, demonstrates the exercise and shows it in slow motion indicating in this way the steps to be followed by the student in performing the exercise. If the teacher because of physical reasons is unable to demonstrate the exercise, it is better to assign two or three students whose movement skills are the best.

#### 2- Verbal method

The use of this method depends on the age of the student, because the older they are easier and fruitful this method is. In this case, terminology of the teacher must be laconic, fluent and adapted to the level of the students. In the use of this method, the main issue is the explanation which requires systematic presentation of knowledge of technique of exercises and the manner of performing the exercises. An example is the topic "chest pass". In this case the teacher explains the position of the body, stepping towards your target with one foot, then throwing the ball out towards the chest with two hands while turning the hands over, ending with the thumbs pointing down. etc.

#### 3- Exercise method

It is an independent method used widely in the learning of movement expressions and development of physical qualities. It consists in two groups:

1- Methods used in the learning of movement expressions which are generally used for the low cycle classes and follow-up classes

2- Methods for the development of physical qualities which are mostly used for the high classes because they are familiar with these exercises and the manner they are performed. However work is focused in improving the quality of the exercise.

Therefore, from the very beginning the students become aware of the movements through demonstrations, as the easiest way to be perceived by the student (mainly from Grade 1-4), then explanation of the exercise which takes less time from the teacher and more time from the student (used mainly for Grade 1-6), because it is assumed that up to these grades, the student has appropriate knowledge in most of the topics and their content. It is important to emphasise that the combination of the first two methods i. e explanation of the new topic and its demonstration. On the contrary, the acquisition of such skills through the frequent and systematic exercise is mostly used for the grades 7-9.

## Result

From the study we have conducted in all the 9-year schools in Tirana, we have concluded in the following data which are reflected in the table and the respective graphs for each methods are herewith below based on the general data of the table. During the physical education classes, starting from the pre-school system to the eights grade the student must perceive and understand easily the topic of the class if the teacher will make use of the demonstration method, because the student of such grades initially becomes informed of all the movement activities. The effect of use of this method is clearly evident from the use of data which we have presented in the following table.

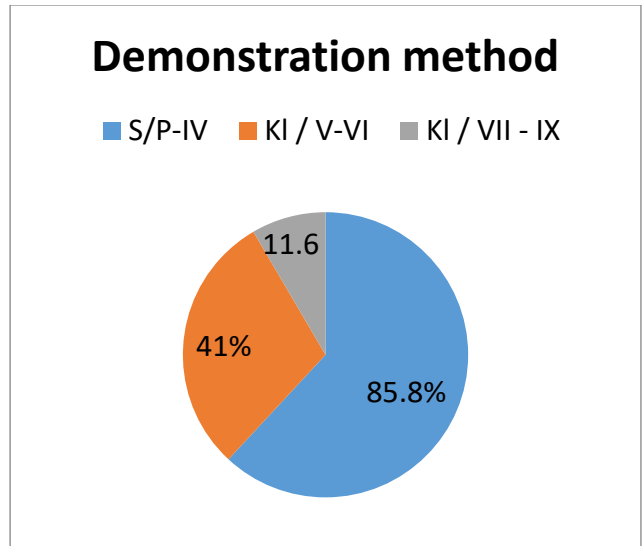
General table

Grade / Methods	Pre-school system	I	II	III	IV	V	VI	VII	VIII	IX
Demonstration method	99. 90%	95%	93%	90%	50%	47%	35%	15%	10%	10%

<b>Verbal method</b>		5%	7%	10%	50%	53%	50%	40%	15%	10%
<b>Exercise method</b>							15%	45%	75%	80%

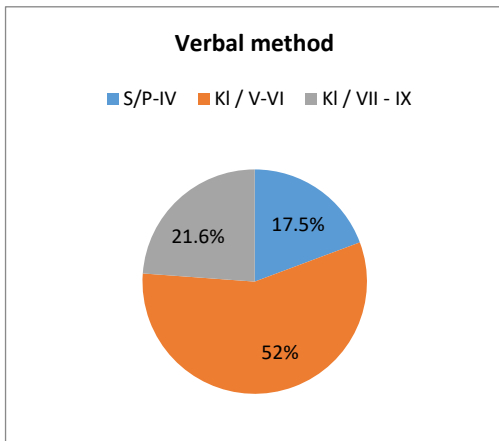
## Specific tables and graphs

	Demonstration method
S/P-IV	85.58%
KI / V-VI	41%
KI / VII - IX	11.66%



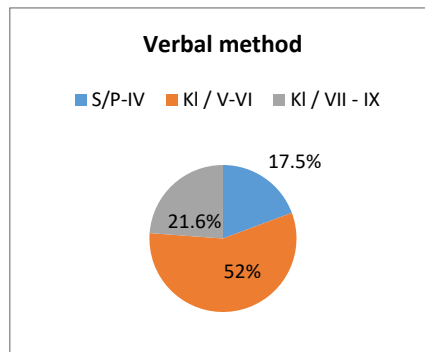
The verbal or explanation method of exercise takes less time from the teacher and more time from the student, thus giving priority to the development of skills of the students. It may be used for the Grades 4-6 because it is assumed that up to these grades, the student has appropriate knowledge in most of the topics and their content. It is important to emphasize that the combination of the first two methods i. e explanation of the new topic and its demonstration.

	Verbal method (explanation)
S/P-IV	17.50%
KI / V-VI	52%
KI / VII - IX	21.60%



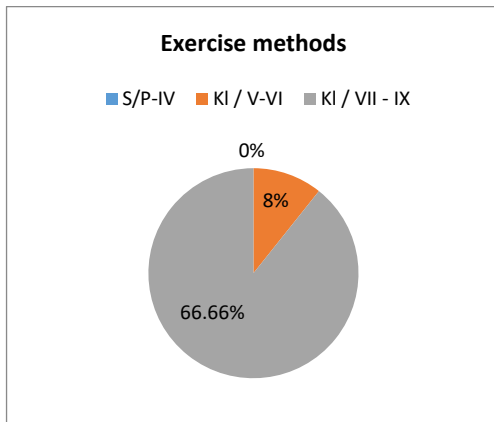
The teaching classes from the seventh to the ninth grade is more active because as a result of a better performance in the lowest grades, the student may be instructed by the teacher and apply them through a repetition of exercise, several times more, and consequently, the movement skills in all the disciplines which the teaching programme contains, are improved

	Verbal method (explanation)
S/P-IV	17. 50%
KI / V-VI	52%
KI / VII - IX	21. 60%



The teaching classes from the seventh to the ninth grade is more active because as a result of a better performance in the lowest grades, the student may be instructed by the teacher and apply them through a repetition of exercise, several times more, and consequently, the movement skills in all the disciplines which the teaching programme contains, are improved.

	Exercise methods
S/P-IV	0. 00%
Gr / V-VI	8%
Gr / VII - IX	66. 66%



## Conclusion

The forms of physical education which are applied by the physical education teacher in the 9-year schools are of special importance because they help in organising as productive as possible teaching classes and attaining the aimed objectives which are closely linked to the improvement of the health of the students and their physical preparation. Therefore, such classes must be organised and delivered in a planned way, fully in line with the purposes of the teaching class and the particularities of the age of the students.

## References

- Prof. DR Jani Daci. Didactic of physical education (pg 10) (2004)
- Wlodkowski, R. Washington DC. Motivation and teaching
- Stavri LLambriiri, "Education Development" Association supported by UNICEF. Minimum necessary objectives of the student (2007)
- Cratty, B, J. Intelligence in Action. Englewood Cliffs ,NJ : Prentice-Hall (1973)
- Rovena Elmazi. Leasure and Recreation Sport. jurnal of Physicol Activity and Sports volume 2 issue 1 August 2014
- Cratty , B,J.Perceptual and Motor Development in Infans and children. New York : Collier-MacMillan Co. (1970)
- Angela Glenn, advisory teacher at Medway ICSS
- Jacque Cousins, manager at the referral unit of elementary pupils
- Gallahue , D. L. Understanding Motor Development in children. New York : John Wiley and Sons (1982)
- Volumes: Play and learning in early years / Eliminating barriers to learning in early years
- Terry F Pettijon : Ohio State University
- Gerhardt, L. A . Moving and Knowing : The Young Child Orients Himself to Space. Englewood Cliffs, NJ: Prentice-Hall (1973)

---

## The Role of Finance on Achieving Companies Goals

**PhDc Fatmir Mehmeti**

Auditing Company "Etika"

[fatmir\\_mehmeti@yahoo.com](mailto:fatmir_mehmeti@yahoo.com)

**PhDc , Dr. Sc Pleurat Mustafa**

Universiteti AAB

[pleuratmustafa@hotmail.com](mailto:pleuratmustafa@hotmail.com)

### Abstract

*The role of companies on economic development, in increasing employment and improving the welfare of its citizen by offering various products and services is continually increasing and having a higher significant role, especially in today's times of economic globalization that we have on. Different companies, whether private or public have their own goals and objectives to achieve where their main goal is profit maximization. The basic element to achieve company's goal and objective is to ensure and manage financial funds. Business owners determine in the accomplishment of objectives, including financial objectives, based on the high competition environment that is persistent and each time more aggressive, in order to survive and to achieve their foreseen goals, the company must continually make investments in (equipment, land, buildings, staff training, new staff engagement, marketing, etc. ), and in order to make these investments possible the company needs to achieve these financial tools, successful management of funds, where the auditing plays a significant role in the successful management. The financial system is undoubtedly a correct catalyst or better yet a laboratory where economic developments take the right shape and form. Complexity and size of organization makes it impossible for the higher management to control each individual if the organization is running its activity in the most effective way. Financial statements are a passport of companies where the management, accounting and auditors are highly linked. The aims of these financial statements are intended to provide reasonable assurance regarding the achievement of key objectives such as: Effectiveness and efficiency of operations, reliability of financial reporting and management, compliance with laws and regulations and preservation of assets. In this paper we will focus on the sources of financial funds of companies, successful management of finances as a basic element of meeting the objectives and internal and external audit as a key element that ensures the success of companies.*

**Keywords:** Finance, Maximization of goals, Financial Management, Financial Statement, Investment, Effectively, Financial System, Auditing

### The role of finance in company

The financial manager plays a dynamic role in a modern company's development. Today, external factors have an increasing impact on the financial manager. Heightened corporate competition, technological change, volatility in inflation and interest rates, worldwide economic uncertainty, fluctuating exchange rates, tax law changes, and ethical concerns over certain financial dealings must be dealt with almost daily. As a result, finance is required to play an ever more vital strategic role within the corporation. The financial manager has emerged as a team player in the overall effort of a company to create value. Thus today's financial manager must have the flexibility to adapt to the changing external environment if his or her firm is to survive.

The successful financial manager of tomorrow will need to supplement the traditional metrics of performance with new methods that encourage a greater role for uncertainty and multiple assumptions. These new methods will seek to value the flexibility inherent in initiatives – that is, the way in which taking one step offers you the option to stop or continue down one or more paths. In short, a correct decision may involve doing something today that in itself has small value, but gives you the option to do something of greater value in the future.

Finance funds are very important in achieving a company's objectives. They are divided into internal and external funds. Usually shareholders have high ambitions on achieving their ideas, and the tendency is to invest in correlation with sales or launching a new product in order to fill the gaps the markets needs, if the internal finance funds aren't enough, the need for external funds and additional funds is seen, whether that is through loan, donation, partnership etc. Therefore finance management plays a crucial role to successfully manage the funds.

If you become a financial manager, your ability to adapt to change, raise funds, invest in assets, and manage wisely will affect the success of your firm and, ultimately, the overall economy as well. In an economy, efficient allocation of resources is vital to optimal growth in that economy; it is also vital to ensuring that individuals obtain satisfaction of their highest levels of personal wants. Thus, through efficiently acquiring, financing, and managing assets, the financial manager contributes to the firm and to the vitality and growth of the economy as a whole.

### **What is financial management?**

Financial management is concerned with the acquisition, financing, and management of assets with some overall goal in mind. Thus the decision function of financial management can be broken down into three major areas: the investment, financing, and asset management decisions.

### **Investment decision**

The investment decision is the most important of the firm's three major decisions when it comes to value creation. It begins with a determination of the total amount of assets needed to be held by the firm. Picture the firm's balance sheet in your mind for a moment. Imagine liabilities and owners' equity being listed on the right side of the balance sheet and its assets on the left. The financial manager needs to determine the dollar amount that appears above the double lines on the left-hand side of the balance sheet – that is, the size of the firm.

### **Financial Decision**

The second major decision of the firm is the financing decision. Here the financial manager is concerned with the makeup of the right-hand side of the balance sheet. Some firms have relatively large amounts of debt, whereas others are almost debt free.

In addition, dividend policy must be viewed as an integral part of the firm's financing decision. The dividend-payout ratio determines the amount of earnings that can be retained in the firm. Retaining a greater amount of current earnings in the firm means that fewer dollars will be available for current dividend payments. The value of the dividends paid to stockholders must therefore be balanced against the opportunity cost of retained earnings lost as a means of equity financing.

### **The importance of the financial management in modern organizations**

If we were to take into consideration certain financial objectives, we might come up with ideas such as: survival; avoiding the financial crises or bankruptcy; overcoming competition; maximizing sales or market rate; minimizing costs; maximizing profits; maintaining an earnings' sustained growth.

Each of these possibilities shows problems that have to be solved by the financial management. If we take each mentioned idea, we might say that, at first sight, the company does not need a financial manager. For example, the sales' increase can be achieved by increasing the loan period offered to the clients. To minimize costs, the company can reduce the research volume of the research-development activity. Bankruptcy can be avoided very easily: we do not take loans or we do not take risks. But are these solutions really the best ones?

We do not borrow money, so we will not have debts and consequently the possibility that the company may go bankrupt because of the impossibility to return the funds does not exist anymore. Then, how will the company be able to finance its investments? Internal sources will never be sufficient enough, especially if the company decides to extend the loan period offered to clients.

**As a conclusion, does the company actually need a financial manager?**

The answer is only one: obviously yes. The financial management plays a key part inside the company. The size and the importance of the financial management depend on the company's size. Inside small and medium-sized companies, the financial management's obligations are generally carried out by the accounting department. Once the company's size takes proportions, the importance of the financial management reflects in the establishment of certain distinct departments, directly subordinated to the company's president or the executive manager's by appointing a vice president of the finances, called financial manager.

Also, the financial management offers solutions for these major decisions of the company: the investment decision, the financing decision, and the dividend decision.

Assuming that the managers' objective is to maximize the company's value, the financial management has to find an optimal combination between the three major decisions. For example, the decision of investing in new assets supposes finding new financing sources. On the other hand, taking a financing decision influences, and is influenced by, the dividend decision because the retained incomes as internal financing sources would in fact belong to share-holders as dividends. The financial management's task is to analyze the effects of each decision and to find an optimal element to contribute to reaching the company's objective.

The financial management belongs to the company's decisional and control under-system, which processes and offers information both from the inside, as well as from the outside. Its basic concern is represented by the under-system's financial funds management, the success of this activity being vital for the company's survival.

The information received by the financial management refers to:

- the funds' investment cost on the capital markets;
- the current rates of exchange;
- the short-term interest rate, employed on the monetary markets;
- the information about the new investment opportunities available to the company;
- the innovation in the financial field and the existence of new financial instruments.

Regarding the decisional system, the financial management will give information about:

- the interest rates which the company is willing to take loans at;
- the future cash flow needs; - the recommendations of long-term debt increase, of shares' issue or a combination between these two;
- recommendations about taking short-term loans or about self-financing;
- the availability of risk management techniques;
- the economic units' productions and the impact on the existing and planned projects.

The financial dimension of a strategy is the one that better answers to the objectives of a company's shareholders: the company's market value maximization and the share's value maximization. Generally speaking, the basic purpose of the financial management's actions has to be company's survival and implicitly its situation's consolidation, demonstrated by getting some worthy market performances. For this reason, its role is to build a frame where the necessary connections between three fundamental variables are about to be established, namely: the company's objectives, the company's market value, the means and instruments used for measuring the company's financial and general performances.

**Interferences and differences between the management of the accounting activity and the company's of the future financial management**

---

The finances represent the means and methods through funds are obtained, controlled, allotted and used. Accountancy is defined by the American Association of Accountancy as it follows: “the identification, evaluation and communication process of the economic information to allow the accomplishment of certain judgments and decisions by the users of that information”

The accounting activity has radically changed the content given by accountancy as a technique. Its purpose established centuries ago was to keep an evidence of the operations, of the incomes and expenses, to make the closing documents for an administration period. Nowadays, its basic purpose is to gather and analyze the information, contributing to the achievement of a competitive management, capable of capturing the future evolution of the economic activity. The risks faced by the company under the terms of a competitive economy make the information generated by qualitative accounting activity absolutely indispensable. Therefore, the accounting activity favours the effective and dynamic information process over the exploitation, financing and investment cycles developed inside the enterprise. Through the delivered data and information, it contributes to the increase of the economic efficiency, being able to determine the performed and employed expenses, the activity's due costs and their level inside the obtained incomes. Moreover, based on the accounting information managers can formulate the company's future strategy. However, it must be mentioned that these information can not be taken as such from the financial statements. They have to be thoroughly analyzed, from the point of view of the indicators that might be built, through the analysis of the external and internal environment, actually making an analysis of the strategic resources of the company.

Therefore, we consider that the accounting activity becomes the support of the financial management's accomplishment in any economic entity. The purpose of the financial activity is to offer the enterprise the financial and technical resources necessary to its functioning and development. The financial activity's practice is never entirely delegated and it stays in a close accounting activity dependency, but it also depends on the general management. Basically, the accountancy evaluates the financial transactions, while the finances manage the financial transactions and the company's basic financial position. Frequently, it has been considered that making reference to the accounting information in the financial statements for the financial analysis and prediction makes the financial management to become an “appendage” of the accounting activity. The vision has seized to exist when the financial management got specialized, even occupying a privileged place in the company's administration.

The investments' opportunity, the surveillance of performance indicators, the budgetary balance in case of unpredicted events, are considered obligations of the financial activity and of the financial management because all financing plans, income and expenses budget, the treasury budget are its scope. But these obligations can not be accomplished but on the information provided by the financial statements elaborated inside the accounting activity.

Although the accounting activity and the financial one might be considered as different functions, they are closely related. In many situations, it is impossible for managers to establish certain tasks just for the financial department. For example, when a before-calculation of the price is required, which is considered an obligation of the financial activity, will also require information about the costs, generated by the managerial accountancy. The interference between the two activities is therefore inevitable.

There are however two basic differences between the financial management and the accounting activity:

The funds' recognition method. The first objective of the accounting activity is to change and deliver information necessary to the measurement of the company's performances, declaring the financial status. Using some generally accepted and regulated standards and principles, the accountants prepare the financial statements that establish the profit or the incomes based only on the registered sales and expenses. On the other hand, the financial manager focuses on the entries and issues of cash flow. He keeps the company's solvency by analyzing and planning the cash flows necessary for paying the obligations and purchasing the assets needed by the company to reach its objectives. The financial manager uses the cash-flow method in order to acknowledge the incomes and expenses, being interested only in the cashflow entries and issues.



---

The decisional process. If the ones involved in the accounting activity focus on collecting the information and showing the financial statements, the financial manager evaluates the situations elaborated by the accounting activity, creates additional information and takes decisions based on following analyses. The purpose of the financial activity is to provide correct and easily interpretable information about the company's past, present and future operations. The financial manager uses this information, either in their initial shape, or after certain processing and analyses, as important entries for the decisional process. Certainly, this does not mean that the personnel which contributes to the accounting activity's development does not take decisions or that the financial manager does not gather information, but it supposes that 599 the accounting and the financial management focus on certain different objectives.

### **Objectives**

Unfortunately, most of the managers only study the financial statements when they want to value the company's performance. For example, the accounting balance reflects the assets at their accounting value. He does not take into consideration their value on the market and does not offer any information about the success of the investments.

A series of researches demonstrated that the role of those with financial or legal training, from the management's superior and the inferior echelons as well, has become more and more important. Therefore, it is more and more important that the employees in the accounting, marketing, production, personnel and other departments to understand the financial field in order to be good professionals in their own departments. For example, accountants should understand the way in which information, delivered by them through the financial statements and other similar reports, is analyzed by investors. The accounting activity's function is to provide the quantitative financial information so that it can be used when taking economic decisions, while the financial management has as basic tasks to plan, to provide, to assign and to use the financial funds, so that the economic entity's value and efficiency to be maximal.

### **The role and function of external auditors**

Financial statements are used for a variety of purposes and decisions. For example, financial statements are used by owners to evaluate management's stewardship, by investors for making decisions about whether to buy or sell securities, by credit rating services for making decisions about credit worthiness of entities, and by bankers for making decisions about whether to lend money. Effective use of financial statements requires that the reader understand the roles of those responsible for preparing and auditing financial statements.

Financial statements are the representations of management. When using management's statements, the reader must recognize that the preparation of these statements requires management to make significant accounting estimates and judgments, as well as to determine from among several alternative accounting principles and methods those that are most appropriate within the framework of generally accepted accounting standards.

In contrast, the auditor's responsibility is to express an opinion on whether management has fairly presented the information in the financial statements. In an audit, the financial statements are evaluated by the auditor, who is objective and knowledgeable about auditing, accounting, and financial reporting matters.

During the audit, the auditor collects evidence to obtain reasonable assurance that the amounts and disclosures in the financial statements are free of material misstatement. However, the characteristics of evaluating evidence on a test basis, the fact that accounting estimates are inherently imprecise, and the difficulties associated with detecting misstatements hidden by collusion and careful forgery, prevent the auditor from finding every error or irregularity that may affect a user's decision. The auditor also evaluates whether audit evidence raises doubt about the ability of the client to continue as a going concern in the foreseeable future. However, readers should recognize that future business performance is uncertain, and an auditor cannot guarantee business success.

Through the audit process, the auditor adds credibility to management's financial statements, which allows owners, investors, bankers, and other creditors to use them with greater confidence. The auditor expresses his assurance on the financial statements in an auditor's report. The report, which contains standard words and phrases that have a specific

---

meaning, conveys the auditor's opinion related to whether the financial statements fairly present the entity's financial position and results of operations. If the auditor has reservations about amounts or disclosures in the statements, he modifies the report to describe the reservations. The auditor's report and management's financial statements are only useful to those who make the effort to understand them.

### **The Financial Statement Audit**

The objective of the financial statement audit is to add credibility to management's financial statements. Access to capital markets, mergers, acquisitions, and investments in an entity depends not only on the information that management provides in financial statements, but also on the degree of assurance that the financial statements are free of material error and fraud. In the process of providing reasonable assurance that financial statements are fairly presented, an auditor assesses whether:

Transactions and amounts that should have been recorded are reported in the financial statements.

The assets and liabilities reported in the financial statements existed at the balance sheet date, and the transactions reported in the financial statements occurred during the period covered by the statements.

Reported assets are owned by the entity and liabilities owed by the entity at the balance sheet date are reported.

The financial statement amounts (assets, liabilities, revenues, and expenses) are appropriately valued in conformity with accounting standards.

The financial statement amounts are properly classified, described, and disclosed in conformity with accounting standards.

The independent auditor forms an opinion on the overall fairness of the financial statements by testing the above representations. The opinion is communicated in the auditor's report. The standard auditor's report contains an unqualified opinion, which means that an auditor believes, without reservation, that the financial statements present fairly the entity's financial position and results of operations in conformity with accounting standards. A qualified report, in contrast, notifies financial statement readers about concerns the auditor has about matters affecting the financial statements (such as the selection of accounting policies or the method of their application or the adequacy of financial statement disclosure) or about limitations in the scope of the auditor's work. Therefore, a user should understand the implications of a qualified opinion and read this type of report carefully.

Therefore we can easily say that an internal and external audit plays a very important role for showing a real state of company to its owners for avoiding risks during decision taking process, especially while investing which are oriented on increasing product quality and services, as a tool of achieving foreseen objective

### **Responsibility for Financial**

Statements Effective use of financial statements requires that the reader understand the roles of those responsible for preparing, auditing, and using financial statements. Management is responsible for the content of its financial statements, regardless of an organization's size or form of ownership. The preparation of these statements requires management to make significant judgments and estimates. Management's responsibility for financial statements is not lessened by having the statements audited.

### **The Independent Audit**

An audit allows creditors, bankers, investors, and others to use financial statements with confidence. While the audit does not guarantee financial statement accuracy, it provides users with a reasonable assurance that an entity's financial statements give a true and fair view (or "present fairly") its financial position, results of operations, and changes in financial position in conformity with accounting standards. An audit enhances users' confidence that financial statements do not

---

contain material error and fraud because the auditor is an independent, objective professional who is knowledgeable of the entity's business and financial reporting requirements.

### **Using Financial Statements**

The auditor's report and financial statements presented by management are useful only to those who make the effort to understand them. Effective use of audited financial statements also requires a basic understanding of accounting standards, the related concepts of financial measurement and disclosure, and the inherent limitations of financial statements caused by the use of accounting estimates, judgments, and various alternative accounting principles and methods.

### **Safety and Financial Statements**

The purpose of the audit is to enable the auditor to express an audit opinion on whether the financial information gives a true and fair view (or is "fairly presented") in accordance with the basis of accounting indicated. Auditors perform procedures designed to obtain reasonable assurance regarding the reliability of management's representations in the financial statements.

Guidelines established by the International Committee of the Auditing Practices recognize three types of services that an accountant can provide financial statements: an audit, a review, and a compilation. Each type of service provides a different level of security, in connection with the presentation of financial statements and disclosures.

### **Financial Statement Audits**

An audit provides a high degree of security for users. The independent auditor's tests of basic data entity's financial statements to obtain evidence that, along with its other procedures, provides the basis for our audit opinion on whether the financial statements are free from material misstatement or fraud (that is, Irregularities).

In an audit of financial statements, the auditor forms a general conclusion about whether -

- financial information has been prepared using appropriate accounting standards, which are applied consistently;
- The financial information in accordance with the statute or the relevant laws;
- The view presented financial information is entirely consistent with business knowledge auditor of the entity;
- There is adequate disclosure of all material matters relevant to the proper presentation of financial information.

### **Conclusions**

Knowledge through financial management will not restrict only to numerical data. For a complete image of the cause and effect type of relations, it is necessary to combine the structured information – data – with the non-structured information – text.

- Consequently, in a society of latest generation information technology knowledge, a Web environment at the level of the whole company allows the interaction, the distribution of results and achievement of the organization's personality.
- The financial management offers the possibility to plan the "way" to achieve the proposed objectives, to cover a well-defined path and to take advantage of the new opportunities which come along.

At the same time, it offers an image of the compatibility between the company's internal processes, the existing financial sources, their cost and way of appropriation, offering strategic recommendations to avoid unpleasant events that may occur.

---

The most decisive matter regarding the financial management is represented by the managing team's level of involvement into the necessary changes. Without a strong involvement, the financial management can not be implemented.

**Recommendations :**

- Effective management of finance affects company performance
- The effect of auditing on accountability and increasing of efficiency on management of finance
- The function of audit system on companies to have effective control
- Auditing ensures a high security for users resulting for a fair presentation of financial statement

**Bibliography**

Dr. Sc. Pleurat Mustafa, lectures by subject Global entrepreneurship and innovation, AAB University, 2014

Dr. Sc. Pleurat Mustafa, lectures by subject Project Management, AAB University, 2014

Mustafa, I. (2008), Menaxhmenti Financiar, botimi i tretë, Prishtine: Riinvest

Muhamet Mustafa: Menaxhimi i Investimeve, Prishtinë, 2009

<http://www.prenhall.com/divisions/bp/app/chapters/vanhorne12.OLDArchive032207/chap01.pdf>

<http://fse.tibiscus.ro/anale/Lucrari2009/100.%20Ciuhureanu.pdf>

file:///C:/Users/Admin/Downloads/The%20role%20and%20function%20of%20external%20auditors%20(1).pdf

Principles of External Auditing by Porter, Brenda (Author) Somerset, NJ, USA: John Wiley , 2003.

Financial Accounting and Reporting 11th Edition Barry Elliott and Jamie Elliott

---

## Different Aspects about the Position of Albanians in Montenegro

Dr. sci. Veton Zejnullahi

### Abstract

*Albanians of Montenegro as an integral and indivisible part of the Albanian nation in its land in Montenegro constitute 4.91% of the total population of the state. The Albanian population in Montenegro is characterized by a powerful diaspora primarily located in the United States of America, and after the war in Kosovo many Albanian citizens from there settled in Kosovo looking for a better life. Although a small percentage in number compared with other nations, Albanians in Montenegro have played an important role in political life and for the future of the state. We must ascertain role and the importance of the Albanian vote in the referendum organized for secession of Montenegro from the State Union of Serbia, which was decisive in achieving the final result in favor of independence. Albanians were the first nation who formed their own political parties, thus supporting Montenegro to become a multiparty state. During the war for the liberation of Kosovo, Albanians in Montenegro played a tremendous role ranging from financing, direct participation in the war, especially in accommodating, hospitality of Kosovo Albanian IDPs in their private home, public buildings, and mosques. The same roles played also the Bosnians population living in Montenegro. Albanian political organization starts with political pluralism and there currently operate several political parties but also the National Council of Albanians.*

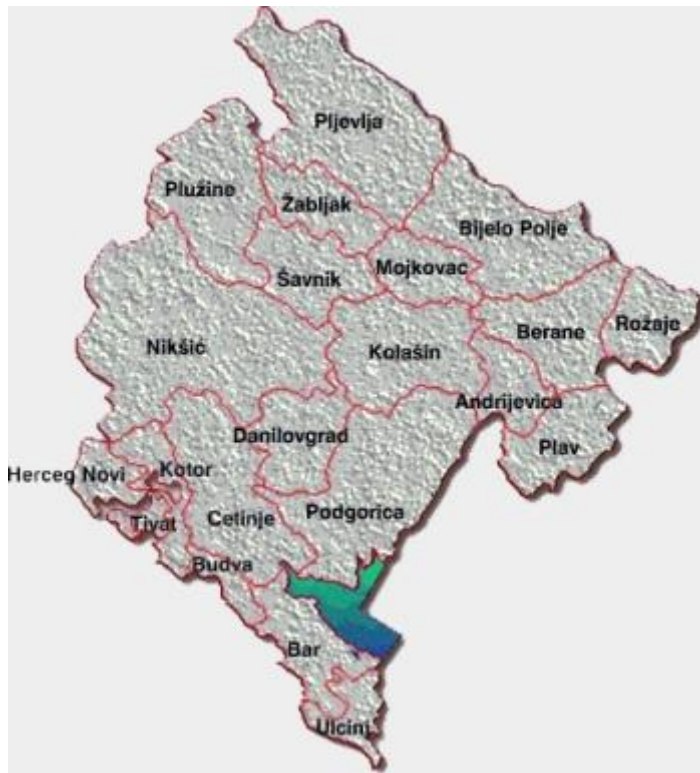
**Keywords:** Montenegro, referendum, Albanians, national rights, the National council

### Introduction

Republic of Montenegro after the Second World War was part of the SFRY, consisting of six republics and two provinces. Montenegro was the smallest republic for the territory and for the number of population, but with a very favorable geostrategic position, because among other things also has access to the Adriatic Sea. Since the beginning of the dissolution of former Yugoslavia, the tiny republic of the Yugoslav federation became the target of attacks by Serb nationalists. In the so-called "Ant bureaucratic Revolution" after massive protests in Titograd (Podgorica today) in January 1989 party and state leadership of Montenegro resigned, replaced by allies of the Slobodan Milosevic. After the Yugoslav federation was dissolved in April 1992 with the independence of the republics of the then, in the federation remained only Serbia and Montenegro, announced the Federal Republic of Yugoslavia (FRY) on 27 April 1992. After this period, although the former allies and relation between the two republics began to fester, especially after NATO's intervention during the war in Kosovo. In 2003, the Federal Republic of Yugoslavia was reconstituted and changed its name to the State Union of Serbia and Montenegro, but the union was not long-lived, and was dissolved by the declaration of independence of Montenegro on 3 June 2006. For this reason the referendum was organized, which led to the mobilization of non-Serb peoples of Montenegro for a massive participation. Precisely in the referendum held on 21. 05. 2006 Albanian citizens traveled from Europe, America and many remote locations with the intention of declaring independence of Montenegro. Albanian vote increased this value due to the fact that the international community demanded from Montenegro to declare independence, not 51% as usual, but 55% of the citizens. The results demonstrate the importance of the Albanian vote, because in the end it turned out that 55.5% of the citizens of Montenegro declared the independence of their country. Viewed in municipalities where Albanians live observe a massive output and a deep result in favor of independence as for example in Ulqin 88.50%, in Plavë 78.92%, and 91.33% in Rozhaje<sup>1</sup>. It is very interesting that this referendum joined the Albanian political factor and acted in the interest of the declaration of independence of Montenegro, even being decisive in the final outcome, but otherwise never managed to join and appear unique and a joint list for the national elections and that in turn will bring the greatest number of Albanian MPs in the Parliament of Montenegro.

---

<sup>1</sup> <http://www.osce.org/sr/odihr/elections/montenegro/20099?download=true>



*Map of Montenegro<sup>1</sup>*

### **The purpose of the paper**

The purpose of this paper is to show the state of Albanians in Montenegro, focusing on the historical, political, economic, education, health, national rights - the symbols and language, information, migration and many other problems facing Albanian population in this Republic. Also, will emphasize the role of Montenegro during the war that led to the breakup of the Yugoslav federation and the process of independence of Montenegro and the role of Albanians in the process.

Viewed from the historical aspect Montenegro has a sensational stories ranging from ancient times when it was Illyrian territory to the rule of the Ottoman Empire centuries was part of the Vilayet of Shkodra, which in itself had four Albanian and Montenegrin kaza up the Treaty of San Stefano in 1878 and the Congress of Berlin that year when was recognised as Slavic state. Thanks to the Treaty of San Stefano and Berlin Congress, Montenegro were added thousands of square miles including much land that today is part of Montenegro? Ulcinj, Bar, Tuzi, Hoti, Gruda, Rozaje, Plav, Gucia are Albanian lands were given to Montenegro.

In general, the Treaty of San Stefano Montenegro will be given a territory of 15,700 km<sup>2</sup>.<sup>2</sup> And included a threefold greater territory, but which would revise the Treaty of Berlin was given an area of 9,100 km<sup>2</sup>.<sup>3</sup>

<sup>1</sup> [http://www.cgautentik.com/index\\_o\\_crnoj\\_gori.php](http://www.cgautentik.com/index_o_crnoj_gori.php)

<sup>2</sup> Puto, Arben, Cështja shqiptare në aktet ndërkombëtare të periudhës së imperializmit (1867-1912), vëllimi I, Tiranë 1984, pg.16

<sup>3</sup> Po aty,pg.16

Map of Albanian vilajets<sup>1</sup>

### Political developments in the nineties of the 20-th century

After the collapse of communism and the introduction of political pluralism throughout Eastern Europe and the former Yugoslavia and, consequently, Montenegro was involved in this huge wave of change moving from one-party system of state organization in the pluralist parliamentary democracy. Albanians were the first who formed their own political parties initially with the Democratic League of Montenegro and later was enriched with other Political parties. Otherwise past two decades pluralist lives in Montenegro are formed over a hundred political parties, but most of them were short life.

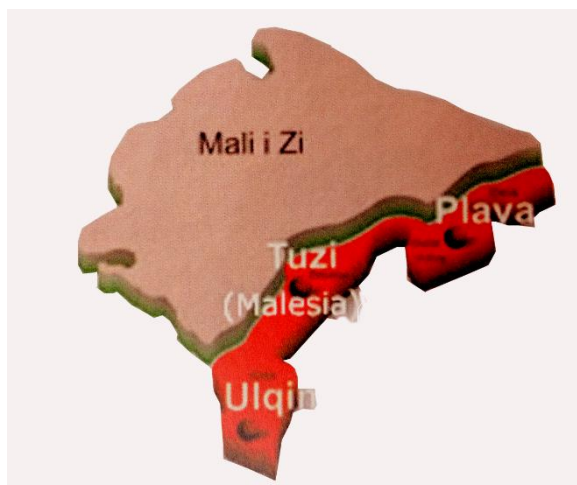
Montenegro as part of the Federal Republic of Yugoslavia along with Serbia could turn the bloody wars that led to the breakup of the former SFRY, the more so since the beginning of the war in Croatia more volunteers peered Montenegrin side by side with the Serbian military and paramilitary formations in the war against Croats claiming to participate Croatian territory respectively strategic part called Konavle and Prevlaka, and were marked especially during the bombing of the city of Dubrovnik. However, after the departure of Momir Bulatovic from Montenegrin political scene, Milo Djukanovic's government distanced itself from invasive wars concentrating on preparing Montenegro for secession from Serbia. In the meantime, position of Albanians was getting worse as a result of anti-propaganda led by Belgrade.

With the pretext of the call to military service and sending Albanian youth in war fronts, many young people were forced to leave and settle in different Western countries and in the USA, which greatly influenced the further reduction of the number of Albanians in Montenegro.

<sup>1</sup> <http://www.pashtriku.org/?kat=60&shkrimi=1027>

During the campaign of NATO air strikes against the Federal Republic of Yugoslavia, that the attack had targeted many naval and air bases where the Yugoslav army stationed on the territory of Montenegro, Montenegrin government held a constructive attitude being distanced from the federal government and giving support to Serbian opposition, even though their accommodation in Montenegro after being the target of persecution of the regime of Slobodan Milosevic, as happened with the Democrats leader Zoran Djindjic, who some years later was elected Prime Minister of Serbia but that was executed in a assassination of Serbian nationalists.

### The political organization of the Albanians in Montenegro



#### *Albanian settlements in Montenegro*<sup>1</sup>

After the introduction of political pluralism in Montenegro, the Albanians were they among the first who formed their own political parties. Democratic League of Montenegro is the first Albanian formed in Montenegro. Currently there are ten Albanian political parties: This is a list of Albanian political parties based on the last election coalitions:

: The Coalition "For the Union" has three political parties: New Democratic Force (FORCE), Civic Initiative Party and Movement "Perspective". Other political grouping "Albanian Coalition" with three other parties: Democratic League, the Democratic Party and the Albanian Alternative. It is the party's long-standing ethnic Albanian Democratic Union (UDSH), then Albanian Youth Alliance, and now two new parties: Civic Initiatives Albanian Party ("Party of Plav") and the Alliance Party of Albanians ("Party of Gucia), what really gets that for every 2,000 Albanian voters exists a political party.

Since the first elections held in 1990 and until last elections Albanians have always been represented in the Assembly and the number of members varies depending on their organization. The largest numbers of deputies have had in the elections of 1996 with a total of four members<sup>2</sup>. It is important to note that the Albanians consistently included in the Montenegrin national party lists, thus giving citizens the character of these parties even some of them have managed to be elected deputies. The case of representation usually occurs with the Prime Minister Milo Djukanovic's party - the Democratic Party of Socialists (DPS).

What characterizes the Albanians in Montenegro as the Albanians in Macedonia and the Presevo Valley is disunity and division into many smaller parties to fully suits the power. Albanians never come out with a list of national elections or local municipalities in which endanger eventual defeat. For more recent local elections for the municipality of Ulcinj Albanian parties lost their majority by the ruling DPS and if it were not great pressure of public opinion by the citizens there as well

<sup>1</sup> <http://www.malesia.org/wp-content/uploads/2013/06/zonat-shqiptare-mal-i-zi2.jpg>

<sup>2</sup> <http://www.pobjeda.me/2012/03/06/visestranacki-zivot-u-crnoj-gori-od-stotinak-partija-prezivjela-petinal#.VApm2PmSydg>



---

as pressure from Pristina and Tirana to create a post-election coalition was risk that the only municipality governed by Albanians be lost and fell into the hands of Montenegrin parties.

### **The role of Albanians in Montenegro during the Kosovo war**

KLA war for freedom and independence of Kosovo as a challenge -century helped and supported in various forms by the Albanians of Montenegro. Montenegrin Albanians were very active in accommodating Albanian citizens evicted by Serb forces especially the Dukagjin valley, then direct participation in the war of giving donations to numerous war service.

City of Rozhaja was as gateway to evicted citizens who settled in private homes of Albanians as well as religious and cultural facilities. With tens of thousands of Kosovo Albanians settled in Albanian cities in Rozhaje up in Ulcinj or through them crossed into Albania. Besides accommodation citizens became the supply of food and medicines to the KLA soldiers to the Dukagjin Operational Zone based in Rugova Mountains and in many cases the transfer of wounded soldiers and their medical treatment was done at Albanians houses in this cities.

It should definitely be noted that any institution from Kosovo did not see reasonable at least express a public thanks to the Albanians of Montenegro for their contribution during the war for the liberation of Kosovo as it did with Albania and Albanians in Macedonia. Setting a grateful slab to Rozhaje or Ulcinj would be justification for all the activity and a message for future generations witnessing that their ancestors have contributed to the freedom and independence of Kosovo.

### **Current problems of Albanians in Montenegro**

Even after the independence of Montenegro Albanian citizens are faced with many problems that are the basic terms of national rights. The problem that worries is that of higher education in the native language so the lack of a University that will meet their needs with new cadres. So the only option is to study in Pristina and Tirana. Even after many requests, still not opened any institution of higher education in the Albanian language. This region is known as a very strong educational and argued that the school first was opened in 1892 in Skje-Kraja<sup>1</sup> followed in the coming years with the opening of schools in other Albanian areas. Otherwise, from these areas is also the author of the book John Buzuku first Albanian "Meshari" in 1555.

Another problem is the health because there is no single hospital as seen from the official list of hospitals published by the Ministry of Health of Montenegro<sup>2</sup>, in the region except a certain number of ambulances that in no way that do not fulfill the needs, so for any serious health problem people have to make tens of kilometers to receive necessary medical services. Not the best situation is also with information, no information in their mother tongue, where besides several local televisions there is no television or newspaper which would cover the entire territory in order to inform as quickly and efficiently to citizens.

Albanian citizens are deprived from their right to use their national symbols such as the use of the national flag and official use of Albanian language. The official documents today issued only in Serbian and Albanians do not enjoy any right in this regard. In this area occurs even greater discrimination for Albanian citizens because adjective of Albanian citizens was added Slav suffixes - iq and viq.

Currently the most preoccupying problem of this region is a migration which has taken off, especially after the visa liberalization that the EU decided to Montenegro. The causes of this migration are numerous ranging from security issue, then the lack of perspective and economic development of the region has influenced young Albanian people which have been educated in the Kosovo and Albania, based on the lack of perspective the youth remain there because the opportunity for employment is greater.

---

<sup>1</sup><https://vargmal.org/lg/dan2529>

<sup>2</sup> <http://www.mzdravlja.gov.me/ministarstvo/linkovi>

In addition to migration in western countries and the USA, Albanians from there after the liberation of Kosovo have started to settle with their families in Kosovo that is impacting greatly reduce further the number of Albanians in Montenegro.

### **The economic development perspective**

Albanian regions in Montenegro in addition of being important in geo-strategic terms are rich with underground wealth and provide favorable conditions for economic development. The main branch of the economy is tourism. In Albanian areas is developed summer tourism on the coast of Ulcinj beaches and winter tourism in the wonderful slopes near Rozhaja that appropriate investments would become attractive places for foreign tourists who practice the sport of skiing.

Another important branch is agriculture, particularly livestock because climatic conditions are such that enable the development of a highly production and processing industry of dairy products.

Characteristic of the Albanian lands in Montenegro is of Wood production and processing, especially the construction of wooden houses. It is up to government bodies to invest in forestation of high mountains which offer high-quality trees with the only purpose that this area transform into an industrial wood processing which in turn will also generate new work places.

Another important sector is energy and wind energy production as a product which is supported and favored by Kiotos agreement. Knowing that Montenegro is the only ecological country in the World, this form of production is favored also by the state because it does not cause environmental pollution.

### **Conclusions and Recommendations**

- Albanians should join the National Council and elect all its organs ranging from the Assembly of the Council. The role of the National Council as the government should be in the shade and will have the following duties:
- Design and development of policies such as economy, politics, education and health and in all areas of life where Albanians remain unrepresented
- To prepare the projects for the opening of a higher education institution and the opening of new hospitals
- Establish News Agency, Radio and the daily newspaper in order to inform the internal and external public
- To request from two Albanian states (Republic of Albania and the Republic of Kosovo) to open offices of the Council, respectively in Tirana and Pristina especially with the aim of trade and tourism promotion
- To request the Government of Albania that to Montenegro Albanians equipped with double citizenship by given to them Albanian passports.
- To prepare the project for establishment of the Association of Albanian Municipalities (including the municipality of Tuzi) that would enable the special status of political, administrative, etc. , a position which would improve the position of Albanians in particular in relation to the treatment of the Republic Montenegro for this region.
- To request the Government of Kosovo to condition the establishment of diplomatic relations with Montenegro to the advancement of human rights and the constitutional position of Albanians
- To organize the regional and international donors and potential investors conference who would allow economic development of Albanian municipalities a step that would open the way to further development in all areas taking into account the importance of economic development and its impact on sectorial policies that would increase the number of employees as well as social welfare of citizens but that will affect and the return of those who are moved.

- To establish institutional and social cooperation in all possible areas of cooperation and all levels of representation with the Republic of Kosovo, the Republic of Albania, Albanian diaspora, the Albanians of Macedonia and the Albanians of Presevo Valley
- To make the opening of higher education institutions with regional and international character which will enable not only national integration of Albanians from all Albanian territories but also the citizens of neighboring countries by promoting regional cooperation as a condition for European integration and conflict prevention.
- To develop projects for the urbanization of the Albanian lands as a precondition for the development of tourism and its promotion as an opportunity for economic development and growth of living standards.
- Request by the Government to stop the application of the introductory fee for Albanians in Kosovo and Montenegro, as did the Albanian citizens of Presevo Valley

## BIBLIOGRAPHY

Puto, Arben, Çështja shqiptare në aktet ndërkombëtare të periudhës së imperializmit (1867-1912), vëllimi I, Tiranë 1984, f. 16

<http://www.osce.org/sr/odihr/elections/montenegro/20099?download=true>

[http://www.cgautentik.com/index\\_o\\_crnoj\\_gori.php](http://www.cgautentik.com/index_o_crnoj_gori.php)

<http://www.pashtriku.org/?kat=60&shkrimi=1027>

<http://www.malesia.org/wp-content/uploads/2013/06/zonat-shqiptare-mal-i-zi2.jpg>

<http://www.mzdravlja.gov.me/ministarstvo/linkovi>

<https://vargmal.org/lq/dan2529>

<http://www.pobjeda.me/2012/03/06/visestranacki-zivot-u-crnoj-gori-od-stotinak-partija-prezivjela-petina/#VApm2PmSydg>

Zenelaj, Eqrem, Çështja shqiptare nga këndvështrimi i diplomacisë dhe gjeopolitikës së Austro-Hungarisë (1699-1918), Prishtinë 2010

Nedokucivi Balkan, Hesperia 2009, Beograd

Lisen Bashkurti, Krizat ndërkombëtare. Tiranë, 2008

Lisen Bashkurti, Mbi të drejtën ndërkombëtare dhe organizatat ndërkombëtare, Gerr, Tiranë, 2006

---

## Workers' Protests in Northern Portugal in the Transition from the Monarchy to the I Republic

Célia Maria Taborda da Silva

Ph. D, Professor of Contemporary History

Lusófona University of Porto

Email; celia.taborda@ulp. pt

### Abstract

*The working class begins to be expressed in Portuguese society in the late nineteenth century, with the development of industrial capitalism and the consequent increase of workers in the industry. But it is in the early twentieth century that strengthens trade unionism and, with him, the statement of the labor movement. From here the working class associations distance themselves from the Socialist Party and betting in the labor union movement as a privileged vehicle of action, rescuing from the strike as a means of social demands. The Republic (1910) is in response to changing desires felt by the working class, watching up, from 1911, to a change in the structure and conduct of the union movement, which resulted in a series of strikes and completely destabilized the republican regime.*

**Keywords;** Working class, protest, portuguese, monarchy, republic

### 1. Introduction

The industrialization process in Portugal occurred slowly throughout the nineteenth century, preventing the formation of a large and cohesive working class. In fact, before the industrialization, the word "class" was used as a reference to a group of workers, such as the craftsmen, artisans, artists, who, having acquired artistic knowledge and skills, enjoyed a certain social distinction (Mónica, 1986: 9). The concept of working class was born within the industrial era.

At the beginning, the factory workers were not highly qualified and only performed simple tasks. They came from rural areas near Lisbon and Porto and daily commuted to these cities to go to work, but, at the end of the day, they would return to their homes in the countryside (Fonseca, 2<sup>o</sup> vol. : 19). This context prevented the manufacturing workers from having the notion of class consciousness and a sense of union. Actually, a long path would have to be followed before this class awareness became a reality.

The first trade unions were associations of crafts, reminiscent of the ancient brotherhoods of crafts, and shared objectives of cultural nature and mutual support (Cabral, 1988: 19), such as the assistance in disease states and death situations. Within a legal context, it could not be otherwise, since the associations of crafts had been banned in 1834 and their existence would only be permitted in 1891. However, the mutual associations proliferated in the two largest cities of the country between 1852 and 1856. In Porto, there were some associations of major importance: the associations of the weavers, tailors, carpenters, dyers, and printers. They all defended their crafts, but there wasn't a unifying center as there was in Lisbon. In fact, in 1853, the Centre for the Promotion of the Working Classes Improvement was formed in Lisbon; it was more structured and had the objective of promoting the association of the working class in Lisbon.

The mutual associations would have a new spirit in the 70s, inspired by the socialist ideology that was spreading in Europe. In 1871, Anselmo Lorenzo, Gonsalez Morago and Francisco Mora, three Spanish workers, members of the International Association of Workers (IAW), contacted Joseph Fontana and Antero de Quental, elements of the Centre for the Promotion of the Working Classes Improvement, in order to integrate the Portuguese working class in the international labour movement, which led to a new organization and new forms of action (Mónica, 1984: 36).

In 1872, and as a result of this approach by the IAW, the association Workers Fraternity was created. It was autonomous from the bourgeois framework and its statutes were influenced by the socialist ideology (Cabral, 1988: 20). A large number of workers with various trades joined the association and, in the same year, the fraternity opened a branch in Porto. However, the association was only successful during its first year of existence; in a few months the number of members

decreased from 3,000 to 300 (Cabral, 1988: 46-47). In 1873, the outbreak of strikes showed that the dispersion still remained within the labour movement, with several associations competing against each other. Two of these associations merged as a consequence of this competition: the *Associação Protectora do Trabalho Nacional* (Protective Association of the National Labour) and the *Fraternidade Operária* (Workers Fraternity) became the *Associação dos Trabalhadores da Região Portuguesa* (Association of Workers of the Portuguese Region), with a federalist and trade union character (Monica 1984: 45).

In 1875, the Socialist Party was formed, presenting itself as a political force able to educate the working class, fostering its participation in the electoral games (Santos, 1994: 330). By that time, there were two parties in the Portuguese political scenario, the Restorative and the Progressive, which represented the forces of capital and industry. A year later the Republicans organized themselves as a political party and tried to link the labour movement to their ideals, using the protests of the workers to do so.

In 1903, through their newspapers *O Norte* and *O Mundo*, the Republicans made sure that the strike of the weavers in Porto was known across the nation. The Republicans had already exceeded the Socialists at the polls (in 1890 they had elected six members) and they aimed at leading the street protests.

The right of association, which was decreed in 1891, strengthened the union within the labour movement, though the working class was still not properly associated, even with the socialist party framework, as reported by Porto newspapers at the time. Actually, the socialist party failed to change the traditional electoral alienation of the working class, and even lost the influence it had in the labour movement, which was gained by the anarchists in the early twentieth century (Santos, 1994: 316. 317). In 1914, the creation of the *União Operária Nacional* (National Workers Union) at the Congress of Tomar marked the split between Socialists and Anarchists and the consequent collapse of the socialist workers' reformism, simultaneously affirming the union's autonomy from political parties (Cabral, 1988: 133).

In 1919, the *Confederação Geral do Trabalho* (General Confederation of Labour) was founded and the "crafts' unionism" gave way to a single union of labour activists, fighting for an ideal of social emancipation (Freire, 1992: 131).

In this article we will analyze the process of workers' protest in Northern Portugal by acquiring rights, through the information that is recorded in the newspapers of the time, in the second half of the 19th century and early 20th century.

## 2. The workers' protests

In the 1870s, the workers in Northern Portugal started expressing their discontent through public protests. In Porto, in 1871, there were strikes organized by the milliners, tailors, dyers, butchers, and stampers. These workers were demanding higher wages and the reduction of the working hours. The wave of strikes continued in the following years and reached its peak in 1877 with the strike of the milliners.

The protests were a consequence of the introduction of machinery and the restructuring of the service that henceforth would be introduced in the *Real Fábrica Social*. The strike lasted a few days and the employers had to make some concessions: apprentices would only be admitted when it was necessary and the machines would be stopped if the excess of production jeopardized the workers' jobs (*O Protesto*, 3-1877). This protest clearly demonstrated the importance of the milliners' corporative past and their privileged status, as if they belonged to the "workers' aristocracy".

In November, there was a new strike organized by the milliners at the factory *Costa Braga*, because of the regulation of the factories' entrances and exits. This was a difficult fight to keep, but with the help of the milliners' class from Lisbon the fight was won (*O Protesto*, 11-1877). In December, in Braga, at the factory *Taxa and Faria*, the milliners protested against the replacement of officials by apprentices (*O Protesto*, 12-1877).

The strength and power shown by the milliners was not extended to the other workers, as there was lack of unity among these latter. In the newspaper *O Operário*, created in 1878, by socialists from Porto, there were constant appeals to the Association of Workers, as a means of claiming better working conditions and salaries and as a way of fighting against the "injustice" and the "unrighteous" regulations which were imposed to the workers in the factories (07/13/1879).

In the eighties there were more strikes. This time it was the workers from the textile industry who organized a demonstration. In the North, in mid 1850s, there were strikes at the textile factories in *Vizela* and *Crestuma* and at *Fiação Portuense*. In

the mid-1870s there were other factories involved, due to the low price of the cotton. In *Guimarães* two factories with more than 100 workers were set up. The decrease in the cost of raw materials led to an expansion of the textile industry, leading some manufacturers to mechanize their weavings (Mónica, 1986: 156). In Porto, the introduction of the machines was a problem for the weavers (*O Operário*, 07. 13. 1879); the weaving industry was responsible for the subsistence of whole families, as referred to by Oliveira Martins (minister) in the 1881 Industrial Survey, therefore, the lack of work was dramatic for these families. Perhaps for this reason the meetings of the weavers became more frequent.

1887 was marked by the workers' constant meetings in the North (attended by workers of both sexes). In February (1887), more than two thousand workers gathered at the Association of Porto. The workers proposed the creation of a committee to negotiate the rise and unification of salaries with the factory owners. They also asked for representation before the Parliament, the creation of trade union councils and the regulation of women and children labour. At the end of the meeting there was an appeal to the Association, as it was considered the only "powerful bulwark in the fight against capitalist exploitation" (*O Protesto Operário*, 06. 02. 1887). The textile industry employed many women and children, once they were cheap labour and usually did not belong to any type of organization or association. Despite these conditions, there are some references to the participation of women in the meetings organized by the Association. In the same year, at a meeting of weavers, one of the few women workers in the Workers Association, the name Rosa da Conceição, intervened and asked all workers to remain united, otherwise "the bourgeois would squeeze them as if they were bagasse" (*Idem*, 05. 08. 1887).

The 1890 crisis led to more strikes. In 1889, the milliners of Porto organized a general strike, which gathered about 1500 milliners, with the support of the milliners in the cities of Lisbon and Braga. They were demanding a raise, which they got after five months of fighting (Mónica, 1986: 46-47). In 1893, the workers of the factory *Costa Braga* went on strike for better wages, a reduction of their working hours to ten and a new Regulation for apprentices (Mónica, 1986: 48). Employers and workers did not come to an agreement and the situation dragged on and sharpened. There were clashes and arrests. This time, the weavers lost the battle and began to lose their claim force (Mónica, 1986: 49).

The turn of the century was particularly tragic for the working classes and their living conditions were progressively degrading. The political and economic crisis, which the country was not able to solve, was reflected in all productive sectors. In 1903, the weavers of Porto went on strike. It was the biggest strike ever and it was widely discussed in the newspapers and the Parliament. For the first time in the labour history, 30,000 workers were on strike, with the support of all textile industry workers (Mónica, 1986: 177). They were asking for a salary raise, the decrease of the working hours, the abolition of fines, the measurement of the fabrics in front of the workers and the concession of priority to the weavers in recruitment processes at the factories (Mónica, 1986: 177). After three months of hard struggle, hunger, and misery, negotiations, intervention of the Government, and clashes with the police, the workers finally got a positive response to their claims: a salary raise, 10 hours of work per day, and the measurement of the fabrics in front of them; the payment of fines was not abolished, but the money concerning those payments was kept in an assistance box.

According to the Portuguese historian Maria Filomena Mónica, this strike was "one of the first genuinely proletarian mass movements of the Portuguese history" (1986: 185) and it may have influenced other movements in the North, as the protest of the textile workers of *Santo Tirso*. In July 1910, the workers of the largest factory in *Negrelos*, in the region of the *Ave*, went on strike. Their claims were similar to the ones in Porto; they were asking for better working conditions and a salary raise, since they earned half the wages of their fellows in Porto (Mónica, 1986: 187). The strikes were spreading to other factories, but the employers were not giving a positive response to their workers' claims. Non-governmental party forces also failed at giving voice to these claims and demands.

### 3. The strikes in the Republic

At the beginning of the twentieth century there were many strikes in Portugal, similarly to what was happening in Europe, namely in England, France and Germany, where there were clashes between employers and workers. The establishment of the Republic (October 1910) did not soothe the workers; on the contrary, it was the opportunity for them to ask the Republicans to pay the promises they had made when their party was in the opposition.

In 1910 there was still discontent among the working classes. The cost of living was increasingly higher and the wages and working conditions clearly worse. In the North, the wages ranged between 400 and 600 *reis* per day, which, according to

---

*Jornal de Notícias (JN)*, was not even enough for a family of 4 to pay half month's expenses concerning commodity prices, bread, cereals, fish, meat, cod, olive oil and sugar (JN, 22/10/1910).

In October, the Federation of Labour presented their protest against the high prices to the Civil Governor of Porto. The Civil Governor guaranteed that the "government of the Republic" intended "to facilitate as much as possible the welfare of their workers and their economic life." The same Governor asked the workers not to raise difficulties to a "new regime that needed to be consolidated" (JN 27/10/1910). His request was not complied with and the demonstrations and strikes soon began.

A month later, the employees of the Gas Company also presented their complaint to the Civil Governor. Their main claim was a salary raise. The Company was facing a difficult financial situation and was powerless to increase the workers' salary. In December, the workers went on strike. The strike was spreading to other workers, as the smelters of the factory *Company Aliança*, and entailed serious damage to other industries (JN, 7 -12-1910); the intervention of the City Council helped to quickly resolve the situation.

The Republic raised the workers' expectations and they considered their interests protected by this political regime, but they soon felt disappointed and frustrated. The first disappointment was related to the tenancy law. As housing was one of the serious problems of the working class, the Republicans announced a law to regulate the relations between landlords and tenants, but when the new law came out there was a profound disillusionment. The law did not establish protective conditions for the poor tenants and maintained the conditions imposed by *Franco's* law, allowing the quick eviction of houses (JN, 11/19/1910).

The second disappointment was related to the decree concerning strikes. The right to go on strike was proclaimed by the Republic, but the Provisional Government considered that the Parliament should be responsible for its regulation. As the working class soon began to make use of this prerogative, the government had to legislate. The Minister Brito Camacho, through the Decree of 6<sup>th</sup> December, imposed severe regulation as far as the right to go on strike was concerned. The decree legislated on coalitions in general, on the ones of public interest and on those which could eventually be prepared by state employees, establishing the ways in which they could be carried out. According to the decree, strikes could not bring disrespect and violence against those who wanted to work (*Comércio do Porto*, 12/09/1910).

The regulation of the working hours was the third disappointment. The working class had long fought for alterations in the law concerning the weekly rest and working hours. The republican government's promise to alter the law had been kept, but the new legislation did not satisfy the workers. According to *Jornal de Notícias*, the law "not only was not regulating working hours, as it was promised, but also made worse the chaotic regime of the weekly rest" (JN, 14/01/1911).

The reaction to the new legislation was almost immediate. The milliners' class Association stated that they were poorly impressed with the "repressive strike law and the law concerning labour regulation and intended to protest" (JN, 01/17/1911). This class was suspicious about the republican regime for its bourgeois character and during the first Republic their suspicion was confirmed once they lost their vindicating power (Mónica, 1986: 58).

The other classes also became disillusioned and the first two years of the Republic were marked by 247 strikes, involving various industries, throughout the country (Cabral, 1988: 235). In the North, there were strikes in the textile, metallurgic, gas and transport industries. The workers' movement began diverging from the Socialist Party, as the latter only supported the general strike as a "last resource" and criticized the general strikes of 1912 (Cabral, 1988: 197). This party considered that the power obtained through elections was the proper way for the workers to achieve their demands. In 1913, taking advantage of the persecution that the democratic government of Afonso Costa was making to the trade union movement and in order to control trade unionism, the socialists convened a congress in Tomar. Nevertheless, the trade union movement was strengthened and the National Workers Union was formed, autonomously from the parties.

The strike was the extreme form of reaction of the working class against the capitalist employers, since other forms of protest, such as rallies and conferences, widely used by professional associations, were not really effective, though they gathered large numbers of workers.

From 1870 to 1910, the strikes aimed at increasing the wages, reducing the working hours and preventing fires in the plants; the strike represented the struggle of a group of workers against their employers. After the implementation of the 1st Republic, the strikes, once spontaneous movements, became organized ones, prepared and validated by trade unions.

The most obvious motivation for a strike is material, but to define the true motivations of workers we have to reconstruct the history of the working class from the beginning, as Edward Thompson stated (1968), seeking explanations beyond the words of its leaders.

After World War I, the voice of the workers changed its tone. The workers' action was no longer confined to the factory or to the place where there was confrontation between employers and employees and acquired the sense of class struggle. The social injustices were widely discussed, surpassing the workers' issues, and were projected onto other spheres of society, including the political power, bringing into light the republican system's own contradictions.

The claims of the working classes became visible and were felt throughout society, since the general strikes affected the normal functioning of institutions and even endangered the state itself. Trade unions, gathering most workers, guided this struggle (Freire, 1992: 130), fostered negotiation, and tried to solve the conflicts.

#### 4. Conclusion

In the monarchic period, the workers could not associate with, much less to strike, making difficult the worker's union and the struggle for their rights.

The workers' protests became more relevant during the I Republic, as the vindicating process had been gaining strength since the beginning of the twentieth century and the workers had acquired class consciousness. The republican parties repressed the working class, suppressing constitutional guarantees, pursuing trade unionists and answering some of their protests with violence. The call for direct action was increasingly widespread by the Revolutionary Unionism and the labour movement, after the I War, exhibited a more ideological and political nature.

#### Primary Bibliography

##### Newspapers:

- O Protesto - 1877
- O Operário – 1879
- O Protesto Operário - 1887
- Jornal de Notícias – 1910-11
- Comércio do Porto - 1910

##### Secondary Bibliography:

- Cabral, M. (1988). Portugal na alvorada do século XX. Lisboa: Presença.
- Fonseca, C. (s/d). História do Movimento Operário. Lisboa: Pub. Europa-América.
- Freire, J. (1992). Anarquistas e Operários. Porto: Afrontamento.
- Mónica, M. F. (1982). A formação da classe operária portuguesa. Lisboa: Fundação Calouste Gulbenkian.
- Mónica, M. F. (1984). O movimento Socialista em Portugal (1875-1934). Lisboa: Imprensa Nacional Casa da Moeda.
- Mónica, M. F. (1986). Artesãos e Operários. Lisboa: Edições do Instituto de Ciências Sociais.
- Santos, M. M. (1994). O partido socialista nos seus primeiros anos – duas eleições perdidas. *Revista da Faculdade de Letras- História*. II série. Vol. XI.
- Thompson, E. (1968). The making of the English working class. London: Penguin books.



---

## Identifying the Ethical Issues in Research and the Process of Gaining the Scientific Titles

Hasan Jashari

SEE University, Macedonia

### Abstract

*Ethical issues in scientific research are very complex, in the same manner as they are delicate. In most of the cases, the researcher needs to collect data from people, in unknown conditions and circumstances with huge social, ethnical, cultural, religious and gender pressure. The issue of ethics in scientific research especially in gaining academic titles is primarily a matter of social practice. We are all witnessing that many research papers are written for scientific titles, and they're based on second and third hand resources, without any first hand research. 2/3 of Master and Doctoral candidates have gathered data from the projects where they did not participate; they have collected and used data from other known and unknown researchers. In Macedonia, the government has established a mechanism for saving and checking master and doctoral papers from 2012 ([www.plagijati.com.mk](http://www.plagijati.com.mk)). This presents a good opportunity for checking the integrity and validity of the academic papers. The researcher's responsibility represents a huge problem. This last decade the government prompted the massive enrollment in the universities as an idea with value, but recently the question whether this is becoming devaluated now is more than questionable? How much the race for profit is influencing the ethical aspect of the scientific and pedagogical research? At this point do the government and the universities thrive to provide quality in the higher education? How much are involved the principles of Salzburg in the third cycle of studies? In Macedonia and neighbor countries there is a huge competition for gaining academic titles. The number of Doctoral holders in Macedonia in 2013 increased for 50.5% compared to year 2012. By using the method of analyzing the documentation we'll gather and interpret data related to research ethics and copyrights of the scientific papers.*

**Keywords:** Ethics, Research, Scientific Titles, Plagiarism

### 1. Introduction

Definition of ethics mostly focuses on the idea that it represents branch of philosophy which deals with moral principles that govern a person's behavior or conducting of an activity. Very often medical ethics also takes part in this definition. Ethics can also be defined as the branch of knowledge that deals with moral principles. But if we want to define the Research as a process, it has another definition. According to Cambridge Dictionary (2003) research it is a detailed study of a subject, especially in order to discover (new) information or reach a (new) understanding. There are many different aspects of research which include: the detailed study of something in order to discover new facts, especially in a university or scientific institution

Other definitions are based on some points and different authors have different opinions how they view this issue. Some think that the research represents making a rigorous and relevant contribution to knowledge. Others define it as a relationship among point A with point B, and by linking these two one new product-C is created. Some others refer to it as an organized inquiry to provide information for the solution to a problem (Emery&Cooper, 1991). According to Kumar (Kumar, 1996) the research is a careful and systematic investigation in some field of knowledge, undertaken to establish facts or principles). (Jung-Su Kim, 2006, p. 4)

### 2. Methodology

This paper is collecting factual data from several first and second hand resources as: literature review and statistical analysis of data of scientific titles in Macedonia. Also, the report of plagiarism from the software of the Ministry of Education and Sciences will be interpreted. (<http://plagijati.mon.gov.mk>)

The data will be interpreted through tables and average percentages.

### 3. Some history and actual debates

Ethical issues in research are as old as humanity. Through time this issues have been defined with legal norms. It is clearly stated which are the processes of copyright, how to save personal and private data, what is called an original work and what is meant by an independent work. Here we have to deal with clarification of what is called our authentic work and how to cite sources used by other authors. Saint Simone and Auguste Comte ended their cooperation, just because of one publication which was not appropriately cited.

At the time of Reich third, the Nazis in the name of scientific research destroyed all ethical borders and tried to use Satanism. The research for genetically modified foods and genetic engineering are very debatable issues, as is the air pollution and those who gain economical benefits by damaging people's health.

The next question tries to find out whether the manipulations done by politicians during the elections can be used in the same way by the scientists as well? At least one minute within a week we need to stop and think about this issue.

All these issues produce many legal and moral norms, ethical codes, councils, committees and associations. But the social practice shows that we have many things to work on. We can check the scientific paper on the software in order to prove how many words or sentences are used from other authors, but we cannot prove whether the interviews are done correctly, whether the collected results of methods are done correctly and how useful they are?

Another question that we need to consider as ethical issue is whether there are any manipulations in the numbers of the collected data and are they influenced by our own beliefs? All this leads to definition of the data validity, and whether we create them or we are just participants of the project?

Many authors agree that to think for ethics means: : to recognize moral and social values which are related to social research, in particular to ask ourselves how do we need to treat the participants. If we refer to Matthews and Ross (Matthews and Ross, 2010, p. 73-81) we need to define in which way we can protect moral standards.

We can conclude that research ethics needs to begin with sincere and precise information, then to add the possible anticipated problems, explain in which way the data will be used, which is your status, validity of data, time needed for participation, copyright etc.

### 4. Literature Review

The scientific literature for moral issues of the researcher is very broad. A huge number of books and manuals are designed for researchers and students, in order to make them aware and increase the responsibility for data collection, selection and interpretation of facts. Probably this originates with Socrates quote: "know yourself" (Socrates on Know Thyself), and then Descartes with *Cogito ergo sum* ("I think, therefore I am"), Kant's categorical imperative etc.

For this paper we have elaborated and used information from the book: *Plagiarism in scientific writing: words or ideas?* (Hadzibadeh, F., Sashok, K., 2011, p. 576–577).

Plagiarism refers to the act of "appropriation of another person's ideas, processes, results, or words without giving appropriate credit". But, at the same time, students cheats in classroom, in exam, homework... Refers to Donald L. McCabe ( McCabe et al, 2001, p. 228) "On many campuses the fundamental element of an academic code honor must be the particularly useful tools for colleges and universities who seek to reduce students cheating,

Most academic researchers reach a consensus that plagiarism is a serious breach of publication ethics . Plagiarism has different forms but can be categorized into two general distinct categories – plagiarism of ideas and plagiarism of text (verbatim). No doubt, plagiarism of ideas is a blatant act of misconduct. Plagiarism of text and recycling of words are also a serious fault in humanities and literature where the essence of work and novelty are wordings and eloquence of the text . But, what about science where the essence of the work is the originality of the scientific content no matter how eloquent it is presented. (<http://www.ncbi.nlm.nih.gov>).

There are some authors who think that schools of ethics in Western Philosophy can be divided, very roughly into three sorts. The first, drawing on the work of Aristotle, holds that the virtues (such as justice, charity, and generosity) are

dispositions to act in ways that benefit both the person possessing them and that person's society. The second, defended particularly by Kant, makes the concept of duty central to morality ( <http://www.oxforddictionaries.com/definition>)

Rosycki in his book *Plagiarism* (2001, p. 7) states that in our everyday life we often do not need to point from where we have taken the information, they just need to follow an interesting story. This differs at schools. Teachers need to know precisely where you got the information and facts, how you interpret them, and most importantly whether they are your or somebody else's ideas.

Therefore, they need to know the source of the information or the author of the paper, information or idea. This leads toward plagiarism. This is a very serious issue, which very often creates trouble for academia.

## 5. How to do a scientific research including ethics?

Ethical issue in scientific research especially in gaining academic titles is an issue of social practice. We can all witness that there are many papers written only for gaining academic titles, with no first hand resources, only second and third hand data.

Plagiarism becomes more present with the massive use of internet in our everyday lives. Earlier when typing machines were used as writing tools there was bigger space for adding comment and suggestions, and nowadays it is easily done by adding and combining texts in much easier way with less effort.

On the other hand, based on many social experiences a huge number of important people like state presidents, prime ministers, ministers, mayors and other public figures had to resign from their posts only because they have broken the ethical issues regarding the scientific titles. This phenomena is not present only in elite circles, but in all social layers. The only difference is that in the elite circles their political responsibility and social control makes them more visible, they are constantly criticized and followed by media and by representatives of public opinion.

Research cannot be done in one particular place, let say laboratory; instead it is done in social and natural environment.

If the research is not done with ethical reflection, it can be harmful. For example, collective data and analytical work with personal information can be very sensitive issue for the individuals as well as for the social groups. The same thing can be applied for the experimental work in general (including people or animals). Nowadays, the researcher needs to consider legal regulations (in educational research the legislation on data protection is probably the most common case), which define concrete barriers for: 'free research'. For these reasons, at these contemporary times there is a rapid increase of the value of research ethics and the issues of academic integrity.

The main principles of research ethics are often represented as follows: ( Zgaga et al.,p. 50)

- Respect for human dignity (to be aware of the humanity of every person, treat people as you want to be treated and never treat them as a means for attaining personal purpose, consider human rights, etc. )
- Benefit (try to maintain quality; there is always a need to find ways for better use of resources, never misuse the participants of the research etc. )
- Justice (the importance of justice, equal access to benefits, respect for privacy, respect for individuals or disadvantaged groups, etc).

Researcher (or the research group), who should conduct the research, needs to respect completely the academic integrity that is required by him / her (them):

- To recognize the contribution of other sources in his/her research efforts;
- To complete an independent research work unless he/she is authorized to request or receive assistance in its preparation;
- To follow research guidelines and stick to standards of the given academic discipline; and
- To avoid, in any form academic cheating.

There is a tendency in all research universities to form committees for research ethics. All research projects where people are involved (sometimes there are researches where animals are involved) and are done by the Faculties, staff and students need to take ethical approval that the research can be conducted before the research begins. The majority of universities including the SEEU (South East European University) have defined their ethical code and the regulation for the scientific research.

Scientific research is closely related to morality and its definition means a habit, action or a behavior becoming a habit. The morality deals with law, tradition, decency, character and purity. In philosophical view the term moral is characterized with tradition, especially best practices which enable harmonious and productive existence of the individual in the society.

## 6. Research data

Form 2012 in Macedonia with all changes in the law for higher education the criteria for gaining academic titles is becoming tougher. The Ministry of Education has database for each formal scientific work and it shows precisely the number of borrowed words from other scientific works. The Salzburg principles are updated, and more often they are used positively in all areas of the research methodology.

Below is presented a practical approach for avoiding plagiarism, used by the formal system of the Ministry of Education and Science.

Table1. South East European University Master and Doctoral students work checked in the Ministry Software for Plagiarism. (The cases are chosen randomly)

Mentorship	Number of MA thesis	PhD thesis	Percentages of borrowed words from other scientific works:
Professor nr 1 Mentor	8	1	2,70
2	14	1	1,92
3	23	1	2,32
4	17	2	3,02
5	6	2	1,65
6	8	0	2,11
7	15	0	2,94
8	12	0	2,30
Total; 8	96 MA thesis	7 PhD Thesis	All: 2,37 %

From these results we can conclude that this system is very practical, but it does not mean that the problem is solved totally. Obviously it helps the process, but the rest of the work depends on us-researchers, to develop self-control and self-responsibility for the academically scientific work. No significant difference between Master and Doctoral thesis related to the number of borrowed words from other scientific works. Percentages of borrowed words from other scientific works for 103 scientific works is 2,37. This result is low

Table 2

**Masters of science according to the scientific field of the master's thesis, sex and age**

	Total		Age groups			
	All	Female	29 Up to 29	30-34	35-39	40 +
<b>Total</b>	<b>1558</b>	<b>895</b>	<b>829</b>	<b>289</b>	<b>194</b>	<b>246</b>
Natural sciences and mathematics	67	35	31	15	7	14
Technical-technological sciences	283	98	158	48	30	47
Medical sciences	15	7	4	3	2	6
Biotechnical sciences	41	22	12	10	9	10
Social sciences	1012	636	553	181	125	153
Humanities	140	97	71	32	21	16

As described in table 2 for Masters of science and specialists, in 2013 according to the data of the State Statistical Office, a total of 1 664 persons obtained the titles of Master of Science and Specialist, of which 1 558 persons or 93. 6% were masters of science and 106 persons or 6. 4% were specialists. Compared with 2012, the number of masters of science and specialists increased by 6. 1%. The participation of women in the total number of masters of science in 2013 was 57. 4%. In 2013, the majority of master's theses, 1 012 or 65%, were in the field of social sciences, followed by 18. 2% in the field of technical and technological sciences, while the rest were in the fields of humanities, natural sciences and mathematics, biotechnical and medical sciences. (<http://www.stat.gov.m> 2015)

**Table 3. Doctors of science according to the scientific field of the doctoral dissertation and age**

	Total		Age groups		
			26 - 29	30- 39	40 +
<b>Total</b>	<b>119</b>	<b>16</b>	<b>110</b>	<b>93</b>	
<b>Natural sciences and mathematics</b>	<b>9</b>	<b>3</b>	<b>7</b>	<b>6</b>	
<b>Technical-technological sciences</b>	<b>10</b>	<b>1</b>	<b>17</b>	<b>13</b>	
<b>Biotechnical sciences</b>	<b>11</b>	<b>1</b>	<b>7</b>	<b>6</b>	
<b>Social sciences</b>	<b>62</b>	<b>10</b>	<b>64</b>	<b>40</b>	

Based on table 3, Doctors of science in 2013, according to the data of the State Statistical Office, 219 persons have gained the title "Doctor of Science", which is an increase of 50% compared with 2012. The majority of doctorate holders, 52. 1%,

have gained their doctorate in the field of social sciences, followed by 14. 2% in technical-technological sciences, 11. 9% in the field of medical sciences, while the rest have obtained their doctorate in the field of humanities, natural sciences and mathematics and biotechnical sciences. The participation of females that have obtained a doctorate during 2013 was 119 candidates or 54. 3% of the total number of doctorates in 2013. Of the total number of persons that have gained the title Doctor of Science, the majority, 55. 7%, work in educational activity.

### 7. Documents found with similarities

This table below presents a detailed report of the PhD candidate related to the work used by others. Their work, as well, needed to be checked before the defense in the Software of the Ministry. In this case the candidate has used data from his MA research in non-ethical way, so that in percentages he has used 1. 28% from his previously used work, and 0. 15% of the general material.

Table 4

Candidate: Blerim Elezi		
Prof. February, 2015	D-r.	HasanJashari
0106 Documents,		
<b>5 exposed documents</b>		

Document from which are borrowed words, sentences ( MA thesis and the name of Author)	Results
<b>SadinSaliu.</b> Author: Sadin Saliu	<b>1. 28% [268/20880 words]</b>  39. 64% [268/676 words]
<b>XhemaliLimaniMAGjistratura.</b> Author: Xhemali Limani	<b>0. 93% [195/20880 words]</b>  28. 85% [195/676 words]
<b>SelimDaku.</b> Author: Selim Daku	<b>0. 47% [98/20880 words]</b>  14. 5% [98/676 words]
<b>DenisDika.</b> Author: Denis Dika	<b>0. 15% [31/20880 words]</b>  4. 59% [31/676 words]
<b>MAdissertation.</b> Author: Nazan Mustafa	<b>0. 14% [29/20880 words]</b>  4. 29% [29/676 words]

## 8. Conclusion

Ethical issues in scientific research are very complex and not much elaborated. First of all, they represent very delicate social practice, and as the time is passing they become even more interesting and debatable. In Macedonia there is an increased trend that scientific works and research need to be sensible when it comes to personal care and responsibility. Statistical indicators show that the use of Principles of Salzburg need improvement, also there is a lack in transparency, innovation and research groups.

Everywhere, teachers, administrators, students should work together to reduce the cheating.

In the future this issue will be even more attacked from public opinion critics, the legislature and various codes of ethics.

## References:

Oliver, Paul (2010) . The students Guide to research ethics, Second Edition, University Press, McGraw -Hill, Education, New York

Kim, Jung-Su (2006). Introduction to Scientific Research . Research Methods in Eng. , 2006 IST, Univ. of Stuttgart, page 4

State Statistical Office. Masters of science and specialists, 2013 (2014). Skopje, Dame Gruev 4, P. box 506 2014, page 1.

State Statistical Office Doctor of Science 2013 (2014) Skopje, Dame Gruev 4, P. box 506 2014, page 1.

Mattews B. ,Ross L. ,2010. Metodot e hulumtimit. Udhezues praktik per shkencat sociale dhe humane. cde. Tirane, page78-83.

Clabaugh. K& Rozycky. G. , Edward (1999). The Plagiarism Book 2<sup>nd</sup> Edition,

Publisher: New foundation.

Habibzede F, Farrok, Shashok Karen (2011). Plagiarism in scientific writing: words or ideas?, Croatian Medical Journal. Aug; 52 (4): page576–577.

**Gilmore Barry (2008). Plagiarism: Why It Happens and How to Prevent It. Paperback – Heinemann Hutchinson School, Memphis, Tennessee**

Pavel Zgaga , Hasan Jashari, Lejla Abazi-Bexheti, Agim Poshka. (2011). Master of Education Students's Final Thesis Dissertation Handbook. In *MA Handbooks*, pp. 3. . SEEU, Tetove, Arberia Design ,page 50.

Klebe L. ,Trevino & Butterfield , D. Kennett, (2001) Cheating in Academic Institutions: A Decade of Research, Ethics & Behavior, 11: 3, 219-232, page 228.

Cambridge Dictionary ( 2003) Cambridge University Press . Macmillan Publishers Ltd. 2002.

Vessal K, Habibzadeh F. (2007);369: 641 Rules of the game of scientific writing: fair play and plagiarism. Lancet. . Journal of Microbiology & Biology Education,

## References to web recourses:

<http://plagijati.mon.gov.mk/userreports/h.jashari> 10. 03. 2015

<http://www.ncbi.nlm.nih.gov/pmc/articles/PMC4278456/> 10. 03. 2015

<http://www.oxforddictionaries.com/definition/english/ethics>, 07. 03. 2015)

---

## Language Selectivity in Lexical Access: an Experimental Study on Bilinguals

**Fatma Demiray**

is currently Instructor Dr. at the School of Foreign Languages, AIBU. Correspondence: Instr. Dr. Fatma Demiray, Abant İzzet Baysal University, School of Foreign Languages. 14280 Gölköy/Bolu-Turkey. E-mail: [demiray\\_f@ibu.edu.tr](mailto:demiray_f@ibu.edu.tr) / [demirayfatma@gmail.com](mailto:demirayfatma@gmail.com) Phone: +90 374 2541000

**Dilek Peçenek**

is currently Assoc. Prof. at Ankara University, Department of Linguistics. Correspondence: Assoc. Prof. Dilek Peçenek, Ankara University, Department of Linguistics, Ankara/Turkey. E-mail: [pecenek@ankara.edu.tr](mailto:pecenek@ankara.edu.tr)

### Abstract

*In this study, the locus of language selection in bilingual lexical access is investigated based on some basic factors such as first languages, second language proficiency, age of acquisition and multilingualism. In particular, this study explores competition between bilinguals' languages and proposes two language selection models; Inhibitory Control Model (Green, 1998) and Concept Selection Model (La Heij, 2005). In experiment 1, the participants were asked to perform a word translation task from their second language (L2) to first language (L1). Each target was accompanied by a distracter item in the form of a picture or a word which was related/unrelated to the target word semantically. As a result, all participants translated target words faster when they are accompanied with semantically related/unrelated word distracters than picture distracters. On the other hand, they translated target words faster when they are accompanied with unrelated word distracters than related word distracters. Finally, they translated target words faster when they are accompanied with related picture distracters than unrelated picture distracters. In experiment 2, participants were asked to perform a switching task with the numbers in their first language and second language according to the background color of the digits. Finally, the language switching cost was larger when switching from L2 to L1 than vice versa. The results have shown that while the factors such as L1 and age of acquisition do not affect the locus of language selection during lexical access, proficiency in L2 and multilingualism factors affect the locus of language selection.*

**Keywords:** Bilingualism, Inhibitory Control Model, Concept Selection Model, Lexical Access

### 1. Bilingual Lexical Access and Speech Production

Bilingual lexical access and speech utterance terms require that language to be chosen to produce can be determined in advance of speech planning. When an Italian- English bilingual is asked to name a picture of a tree in English, he/she will come up with the word *table*. The process that makes the connection between the "idea" table and the word *table* is often referred to as *lexical access* (La Heij, 2005).

Lexical access is only a small part of bilingual language production but a very fundamental step because it bridges the gap between nonverbal thought world and language world (La Heij, 2005; Bloem & La Heij, 2003). Besides, the lexicons in both languages share a common conceptual system. That is, the concept of a tree is the same in both languages but happens to be mapped on to two lexical entries (*table* and *tavolo*) (Schwieter, 2007; Kroll & Stewart, 1994; Kroll & de Groot, 1997).

As it is mentioned, several lexical representations are activated due to spreading activation from the semantic system to the lexical level and thus a selection mechanism is needed. In this mechanism, the semantic system activates both the word that matches the intended meaning and other related items (see Figure 1) (Costa & Santesteban, 2004). Two selection processes are commonly assumed in language production models. These are the selection of conceptual information to be lexicalized (concept selection) and the selection of the response word from a set of activated words (lexical selection) (La Heij, 2005, p. 290).



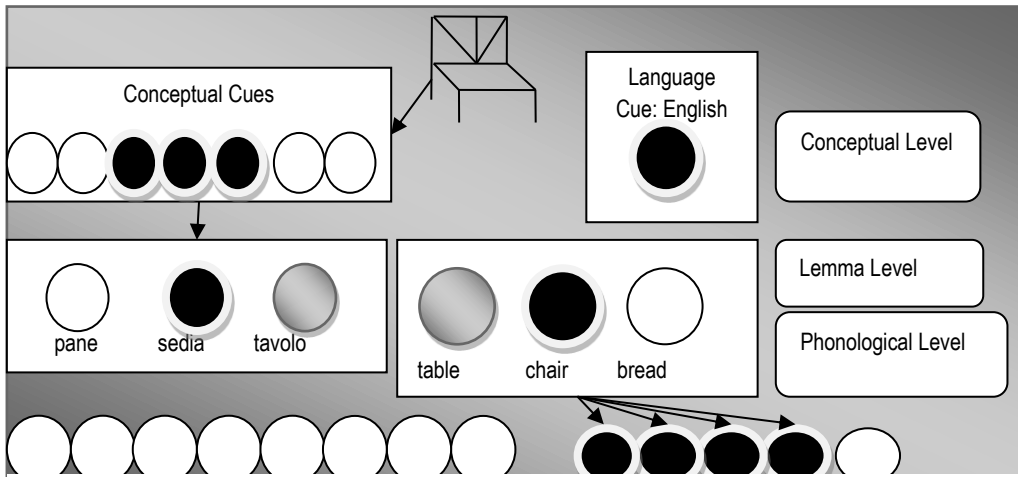
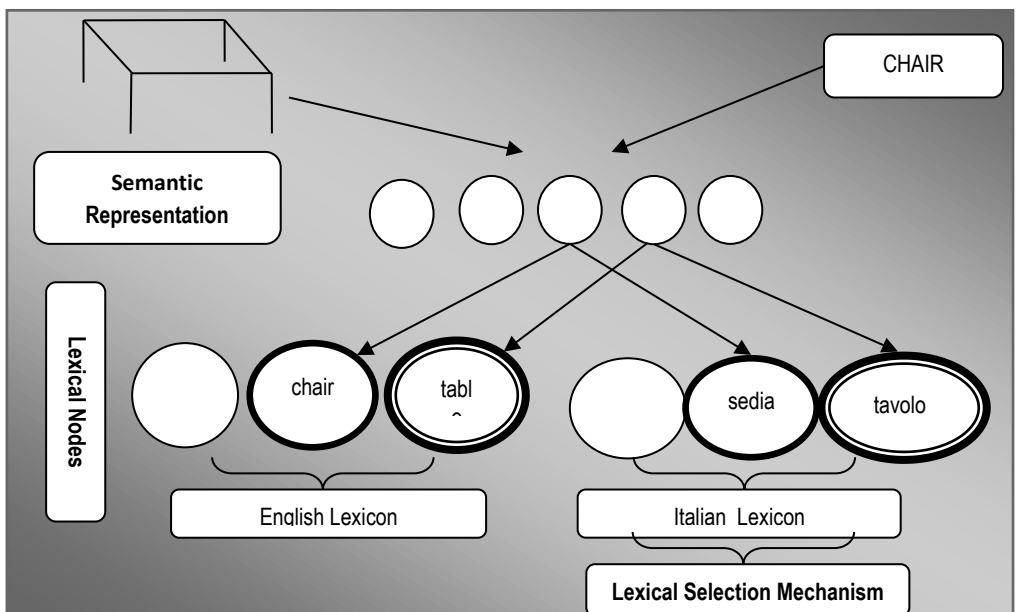


Figure 2. A model of Bilingual Language Production (adapted from Poulisse & Bongaerts, 1994 & Hermans, 2000) (cited in Kroll, Bobb & Wodniecka, 2006, p.120).

**1. 1 Language Specific Selection and Concept Selection Model**

As in Levelt's (2001) proposal lexical access occurs automatically in the sense that it delivers a winner depending on the information in preverbal message and "complex access, simple selection" idea is emphasized. Costa (2005) assumes that during speech planning semantic system activates lexical nodes in both languages however, these nodes do not compete for selection because they have been already selected in preverbal message, in other words in conceptual level. Finally, according to Concept Selection Model (CSM), the most highly activated lexical node in the target language is chosen (Costa, 2005; Kroll, Bob & Wodniecka, 2006; Fishman, 2001; Francis, 2000; La Heij, 2005). Therefore, this selection process is not based on inhibition or suppression as competition does not occur between languages but within languages (see Figure 2).



Some researchers who favor non-specific language selection are opposed to language specific selection hypothesis (Green, 1998; Caramazza, 1997; De Bot, 1992). They assume that there is cross-language activity the languages compete for selection. In other words, lexical nodes in both languages are activated by semantic system (see Figure 3).

The basic hypothesis of Inhibitory Control Model (ICM) is that the selection of one language is only possible after suppression or inhibition of nontarget language. This inhibition is the main reason for longer Response Times (RTs) and more errors. Moreover, more dominant language will take longer time to produce because it has a larger system than weaker language and it will need stronger inhibition.

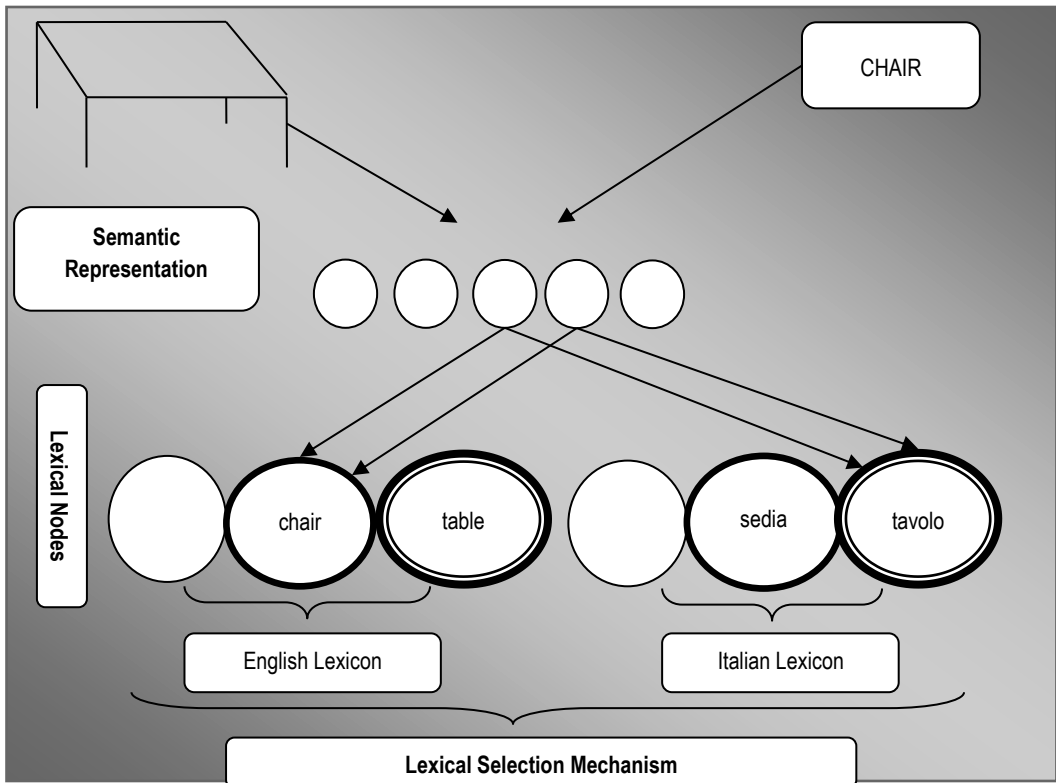


Figure 4. Nonspecific Language Selection Model (Costa, Miozzo & Caramazza, 1999, p.370)

## 2. Method of the Study

This study in which the lexical access and language selection process are supposed to analyze on undergraduate or graduate English learners of Turkish and Italian is based on experimental approach and the data has been observed quantitatively. In this frame, firstly, Oxford Quick Placement Test (OQPT) is applied to determine the proficiency level in L2 of the participants. Afterword, language history questionnaire is performed to reach the participants' demographic information and all participants are grouped into two in terms of L1, L2 Proficiency Level, L2 Age of Acquisition and Multilingualism. After then, two experiments have been designed in the name of Word Translation Task based on CSM (La Heij, 2005) and Numeral Task based on ICM (Green, 1998).

## 2. 1 Overview of the Experiments

The goal of the present study is to examine the underlying processes of bilingual lexical selection and speech production in terms of the nature of bilinguals (i. e. varying types of bilinguals, L2 proficiency level, age of acquisition and multilingualism). In particular, the experiments investigate the loci of language selection and competition based on CSM and ICM. These two distinct theories seek to explore whether speech production are found at conceptual or lexical level.

In Experiment 1, it is investigated that target language is established at the initial stages of the lexical process and other mechanisms such as inhibition are not necessary during speech production process. In the experiment, Italian-English and Turkish-English bilinguals who translated English words into Italian or Turkish are included. Each target word was accompanied by a distracter item in the form of a picture or a word which semantically related or unrelated to the target. To understand whether factors of bilingualism affect these lexical process or the loci of selection and competition, four kinds of bilingual groups are included comparatively. If participants take longer to translate when distracter items are in the form of pictures, it can be concluded that there is a competition at the conceptual level (because pictures activate their conceptual representation). However, if participants are slower to translate when the distracters are words, it can be assumed that there is a competition at the lexical level of the speech production process.

In Experiment 2, the main goal is to examine whether bilinguals suppress the nonrelevant language during speech production. Recall that IC Model expresses the fact that there is a difference between the size of L1 and L2 and that is the reason why more time is required when switching from L2 to L1 than vice versa. Inhibitory mechanism during language switching appears and the words in the nonrelevant language are inhibited in order to produce the target language. This experiment consists of numeral task (from 0 to 9) with language switches. Bilinguals name the digits according to the background color which is seen on the computer screen. If the digits are presented with a blue background color they name them in English. If they are presented with a yellow background color, they name them in Italian (for Italian-English bilinguals) or in Turkish (for Turkish-English bilinguals). All numbers are presented in short lists of switch or nonswitch trials. If participants need more time switching from L2 to L1 than vice versa, it can be assumed that there is a competition at lexical level.

## 2. 2 Oxford Quick Placement Test and Language History Questionnaires

OQPT (Allan, 1992) was conducted to explore the bilinguals' proficiency levels and Language History Questionnaire was used to reach some information about participants' background knowledge about language (s). It was taken from Schwieter (2007) and Marian, Blumfeld & Kaushanskaya (2007) and adapted after pilot study. In this questionnaire, twenty five items were presented to explore L2 early and late age of acquisition of bilinguals and bilingual or multilingual participants.

Additional information about their language backgrounds such as age, use of languages, self-rated scores for reading, writing, listening, speaking and the other languages which have been learnt after second languages of them was obtained.

## 2. 3 Participants and Grouping

A total of 54 participants were recruited from the graduate or undergraduate students who were studying at Roma Tre University, Italy and Ankara University, Turkey. They have different language backgrounds, L2 age of acquisition and knowledge of other languages except from English (L2).

Fifty-four participants took part in the experiments. Participants in Italy were native speakers of Italian and learning English for an average 7 years. These participants were receiving formal training in English as a second language. Participants in Turkey were native speakers of Turkish and learning English for an average of 10 years. Twenty six participants were living in Italy, the rest of them were living in Turkey. Participants from different countries were considered to be L2 learners or late-bilinguals of Italian-English or Turkish-English.

According to OQPT results, the number of the highly and low proficient bilinguals in L2 was twenty-seven to twenty-seven. Twenty two participants acquired the second language in early ages (before 7), thirty two of them in late ages (after 7). Besides, thirty one of the participants only knew second language (English), twenty three of them knew other languages such as German or Arabic for Turkish participants and French or Spanish for Italian participants (see Table 1).

**Table 3.** Descriptive Statistics for the Participant Groups

	L1 Turkish		L1 Italian	
	L2 Proficiency	Low	L2 Proficiency	High
<b>N</b>	16	12	11	15
<b>Age Mean</b>	18.44	26.67	19.73	27.33
<b>Age Range</b>	17-21	23-31	17-25	24-32
<b>OQPTResults</b>	39.31	54.75	36.73	54.07
<b>L2 Age of Acq.</b>	9.25	5.83	8.45	5
<b>L2 Reading</b>	4.25	8.83	4.55	8.93
<b>L2 Writing</b>	3.94	8.08	3.82	8.2
<b>L2 Speaking</b>	3.63	9	3.45	8.87
<b>L2 Listening</b>	4	8.42	3.45	8.8
<b>L2 Self-Expression</b>	3	8.92	4.27	8.87
<b>Level Mean</b>	3.76	8.65	3.9	8.73
<b>L1 Speaking</b>	10	10	10	10
<b>L2 Speaking</b>	3.56	9.33	3.82	9.6
<b>L3 Speaking</b>	1.38	1,5	1.36	1.47
<b>L3 Average</b>	2	6.84	2.15	7.46

### 3. Experiment 1: Word Translation Task

#### 3.1 Materials

Thirty two high frequency English words were selected. The target words in the experiments were taken from Bloem and La Heij (2003) and after the pilot study they were adapted (see Appendix A and B for a description). Each of the target words were presented with a semantically related or unrelated words or pictures. For example, the target word DOG (to be translated into Italian as "cane" or into Turkish as "köpek") was accompanied by the picture of a peach or by the word "pesca" (Italian translation equivalent of peach) or "şeftali" (Turkish translation equivalent of peach) in an unrelated context. However, in the related context the same target word DOG was accompanied by the picture of cat or by the word "gatto" (the Italian translation equivalent of cat) or "kedi" (the Turkish translation equivalent of cat) in a related context. English target words were seen one by one on the computer screen in black-lower case and the distracters were presented in black-lower case immediately over the target words. Half of the participants started the experiment with picture distracters, the other half started with word distracters.

#### 3.2 Procedure

The participants were tested individually in a soundproof room at each university. Firstly in a written and then orally, they were asked to translate L2 words into L1 as fast as possible. Each participant was given a series of 32 trials two times and one of them was given with related distracters, the other was given with unrelated distracters. First, a fixation point for 500ms. appeared on the computer screen. Next the stimulus appeared and remained for 2000ms. If the participant did not

give any answer during this time, the next trial was seen. The researcher took notes for true and false responses simultaneously and also used voice recorder to indicate and judge the responses later again.

### 3. 3 Data analysis

Response latencies of only correct responses (in L1 or L2) were included in the statistical analyses. There are two main variables as picture-word or related-unrelated contexts. The analyses were conducted to each bilingual group separately and T-test was conducted in four phases: a) L1, b) L2 age of acquisition, c) Proficiency level and d) Multilingualism.

### 3. 4 Results and Discussion

The results gathered from word translation task to analyze locus of language selection and competition in terms of CSM were investigated on the basis of context (word or picture) and relatedness (related or unrelated). As seen in Table 2, the statistics have shown there was a significant main effect for context ( $t(107) = -5.44, p=0.000$ ) that is, participants have more difficulty in translating target words when accompanied with pictures (1091 ms.) than words (1026ms.). On the other hand, the same significant effect cannot be seen in relatedness ( $t(107) = -0.31, p=0.755$ ). This suggests that reaction times for translating target words when they are accompanied by related (1057ms.) or unrelated (1060ms.) context were nearly same. It can be understood from these results that words created semantic interference while pictures induced semantic facilitation.

Table 4. Paired Samples Statistics for Context (word-picture) and Relatedness (related-unrelated) in Experiment 1

Paired Samples Statistics						
		Mean	N	Std. Deviation	Paired Samples Correlations	
					Correlation	Sig.
Pair 1	Word	1026,347	108	2093,243	0,863	0,000
	Picture	1091,117	108	2474,211		
Pair 2	Related	1057,457	108	2322,456	0,896	0,000
	Unrelated	1060,445	108	2307,936		
Paired Differences						
		Mean	Std. Deviation	t	df	Sig. (2-tailed)
Pair 1	Word-Picture	-655,702	1,250	-5,443	107	0,000
Pair 2	Related-Unrelated	-316,737	1,050	-0,312	107	0,755

#### 3. 4. 1 L1 Factor and Lexical Access

As a main goal of this experiment, to see whether L1 factor affects the locus of language selection and lexical access process, the participants were grouped into two; English learners of Italian and Turkish. What is appeared from the mean RTs is that all participants were slower when translating target words in picture contexts than word contexts (see Table 3). While it is investigated whether semantic relatedness effect (SRE) differs according to the type of bilinguals, it can be concluded that context words induce semantic interference (-10ms., -24ms.) whereas context pictures induce semantic facilitation (+22ms., +26ms.). As illustrated in Figure 4, in an unrelated or related context, there is a significant difference

between L1 Turkish and Italian participants, however, the semantic relatedness effect is the same for both experimental groups.

According to the independent samples T-test results, there is a significant main effect between participants in terms of word ( $t(106) = 6.01, p = 0.000$ ), picture ( $t(106) = 4.39, p = 0.000$ ), related ( $t(106) = 5.07, p = 0.000$ ) and unrelated ( $t(106) = 4.94, p = 0.000$ ) context. In other words, Italians were faster for all contexts than Turkish participants. To analyze the main effect of the distracters, Turkish and Italian participants are examined separately (see Table 4 and Table 5).

Table 5. Mean RTs (ms. ), Accuracy (in percent) and SRE for L2 Learners of Italian and Turkish in Experiment 1

	L1 Italian				L1 Turkish			
	Word		Picture		Word		Picture	
	Rt	Acc.	Rt	Acc.	Rt	Acc.	Rt	Acc.
<b>Unrelated</b>	912	1,9	1002	1,7	1115	1,1	1197	2,3
<b>Related</b>	922	1,6	980	1,5	1139	2,3	1171	1,4
<b>Sre</b>	-10		22		-24		26	

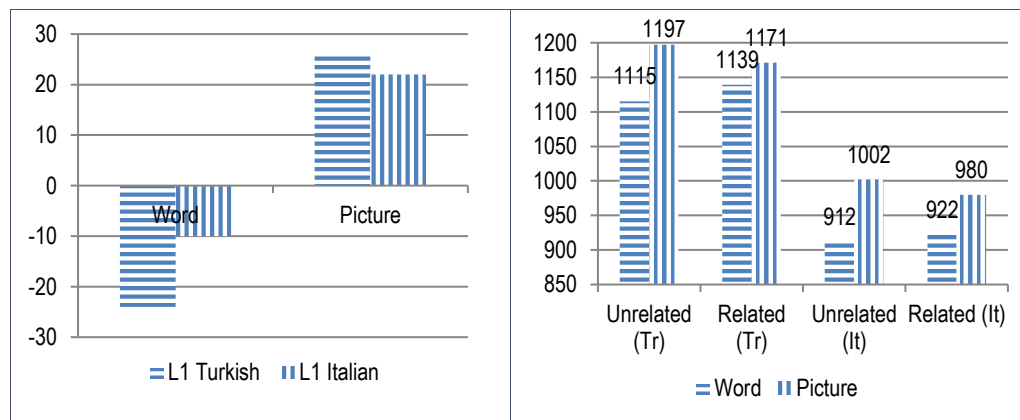


Figure 5. SRE and RTs (in ms. ) for L2 learners of Italian and Turkish in Experiment 1

Paired samples statistics were included for the reason context and relatedness data were collected from each participant group. L1 Turkish participants' mean RTs in picture context is more than word context ( $t(55) = -3.453, p = 0.000, r = 0.811$ ), L1 Italian participants also have similar RTs mean ( $t(51) = -4.233, p = 0.000, r = 0.861$ ). When relatedness effect is analyzed, both L1 Turkish ( $t(55) = -0.04, p = 0.971, r = 0.850$ ) and Italian participants ( $t(51) = -0.419, p = 0.000, r = 0.891$ ) have similar results. Consequently, similar effects were reported for both groups and the results support CSM regardless of what type of bilingual may be. In other words, lexical access occurs at conceptual level.

Table 6. Paired Samples Statistics for L2 Learners of Turkish in Experiment 1

Paired Samples Statistics
---------------------------

					Paired Samples Correlation	
		Mean	N	Std. Deviation	Correlation	Sig.
Pair 1	Word	1127,534	56	1753,289	0,811	0,000
	Picture	1184,921	56	2125,853		
Pair 2	Related	1155,963	56	1972,677	0,850	0,000
	Unrelated	1156,491	56	1967,095		

Paired Samples T-test						
Paired Differences						
		Mean	Std. Deviation	t	df	Sig. (2-tailed)
Pair 1	Word - Picture	-573,867	1243,669	-3,453	55	0,001
Pair 2	Related - Unrelated	-527,661	1079,440	-0,037	55	0,971

Table 7. Paired Samples Statistics for L2 learners of Italian in Experiment 1

Paired Samples Statistics						
					Paired Samples Correlations	
		Mean	N	Std. Deviation	Correlation	Sig.
Pair 1	Word	917,203	52	1881,146	0,861	0,000
	Picture	991,586	52	2447,878		
Pair 2	Related	951,390	52	2215,314	0,891	0,000
	Unrelated	957,400	52	2214,369		

Paired Samples T-test						
Paired Differences						
		Mean	Std. Deviation	t	df	Sig. (2-tailed)
Pair 1	Word-Picture	-743,834	1267,058	-4,233	51	0,000
Pair 2	Related-Unrelated	-601,014	1035,367	-0,419	51	0,677

### 3. 4. 2 L2 Proficiency Level Factor and Lexical Access

To see L2 Proficiency Level affects the locus of selection and competition in the process of L2 lexical access, the participants were categorized into two; low proficient and highly proficient bilinguals in L2. As interpreted in Table 6 and Figure 5, when mean RTs are analyzed, while low proficient bilinguals translate target words faster when they are accompanied with unrelated word context (1216ms. ) than related (1272ms. ), high proficient bilinguals translate slower target words when they are accompanied with unrelated word context (814ms. ) than related (800ms. ). At this point, L2 proficiency does not already support the hypothesis that emphasize language selectivity is at the conceptual level. However, after several significant interactions and t-test statistics it can be reached the objective results.

According to the independent samples test results, there is a significant main effect between the groups on the basis of word ( $t(106)=11.275, p=0.000$ ), picture ( $t(106)=13.694, p=0.000$ ), related ( $t(106)=12.057, p=0.000$ ) and unrelated ( $t(106)=12.093, p=0.000$ ) context. That shows that, high proficient bilinguals were faster than low proficient bilinguals as expected. To analyze the main overall effect of the proficiency on lexical access, both groups are analyzed separately with paired samples test.

Table 8. Mean RTs (ms.), Accuracy (in percent) and SRE for L2 Low and Highly Proficient Bilinguals in Experiment 1

	L2 Low Proficiency				L2 High Proficiency			
	Word		Picture		Word		Picture	
	Rt	Acc.	Rt	Acc.	Rt	Acc.	Rt	Acc.
<b>Unrelated</b>	1216	1,5	1278	1,8	814	1,5	932	2,2
<b>Related</b>	1272	2	1252	1,6	800	1,8	904	2,5
<b>Sre</b>	-56		+26		+14		+28	

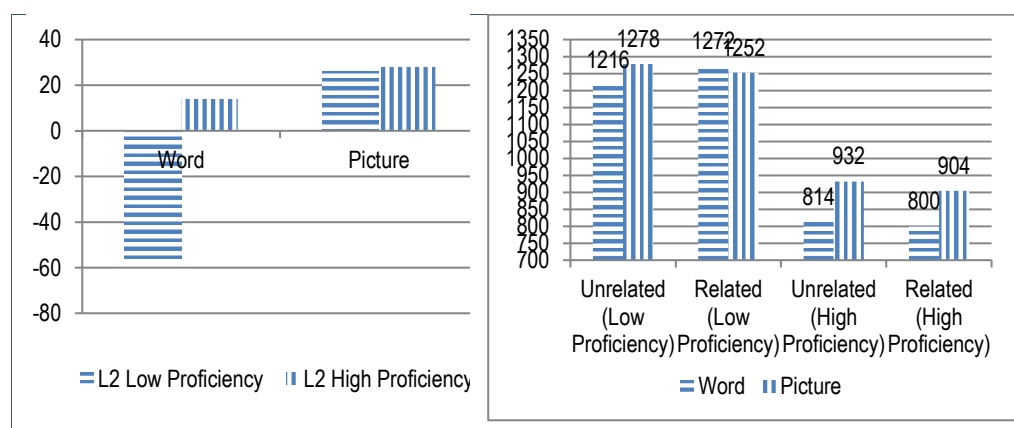


Figure 6. SRE and RTs (in ms.) for L2 Low Highly Proficient Bilinguals in Experiment 1

Paired samples statistics in Table 7 and 8 are included for the same reason mentioned in L1 and language selection. There are several significant interactions which should be reported and emphasized. Firstly, for context and relatedness, only low proficient bilinguals could not get significant effect for context ( $t(53)=-5.72, p=0.776, r=0.624$ ) and for relatedness ( $t(53)=-0.14, p=0.886, r=0.769$ ). However, high proficient bilinguals could get significant effect only for context ( $t(53)=-1.809, p=0.004, r=0.750$ ) not for relatedness ( $t(53)=-0.31, p=0.756, r=0.729$ ).

All in all, low and highly proficient bilinguals are affected from different lexical selection processes. Thus, it can be hypothesized that low proficient bilinguals are probably using inhibitory control mechanism to be able to choose the correct language since the language cues in L2 may enter the selection process only after the suppressing of nontarget language nodes.

Finally, it should be emphasized that after the second experiment on ICM, it will be possible to reach a final and exact result about lexical selection process of them.



Table 9. Paired Samples Statistics for L2 Low Proficient Participants in Experiment 1

Paired Samples Statistics						
					Paired Samples Correlation	
		Mean	N	Std. Deviation	Correlation	Sig.
Pair 1	Word	1244,123	54	1503,705	0,624	0,000
	Picture	1265,665	54	1690,411		
Pair 2	Related	1262,264	54	1694,468	0,769	0,000
	Unrelated	1247,524	54	1687,400		
Paired Samples T-test						
Paired Differences						
		Mean	Std. Deviation	t	df	Sig. (2-tailed)
Pair 1	Word - Picture	-1085,420	1394,759	-5,719	53	0,776
Pair 2	Related - Unrelated	-2259,76	1150,254	-0,144	53	0,886

Table 10. Paired Samples Statistics for L2 Highly Proficient Participants in Experiment 1

Paired Samples T-test Statistics						
					Paired Samples Correlation	
		Mean	N	Std. Deviation	Correlation	Sig.
Pair 1	Word	807,404	54	1326,957	0,750	0,000
	Picture	918,003	54	1266,948		
Pair 2	Related	852,666	54	1311,833	0,729	0,000
	Unrelated	873,741	54	1292,375		
Paired Samples T-test						
Paired Differences						
		Mean	Std. Deviation	t	df	Sig. (2-tailed)
Pair 1	Word - Picture	-2259,820	918,143	-1,809	53	0,004
Pair 2	Related - Unrelated	-4074,980	958,627	-0,312	53	0,756

### 3. 4. 3 Age of Acquisition Factor and Lexical Access

Supposing that highly proficient bilinguals acquired language in an early age and low proficient bilinguals in a late age, the participants were grouped into two. However, it is surprising that some highly proficient bilinguals acquired the language in a late age during their staying in an English native country for education or other reasons. Similarly, some of low proficient bilinguals acquired the language in an early stage however, since they did not use it productively, they probably forgot it. Thus they were grouped again according to the results of questionnaire. When analyzed their mean RTs (as Table 9 and Figure 6 illustrate), those in late age of acquisition translated target words in context or relatedness effect slower than those

in early age of acquisition. This interpretation shows the parallel results to the hypothesis of CSM. In other words, the participants in each group select language at conceptual level. Just as L1, age of acquisition independent samples analyses show that there was an overall main effect for word ( $t(106)=-7.895, p=0.000$ ), picture ( $t(104,781)=-9,145, p=0,000$ ), related ( $t(105,605)=-8,468, p=0,000$ ) and unrelated ( $t(105,99)=-8,694, p=0,000$ ) context.

Table 11. Mean RTs (ms. ), Accuracy (in percent) and SRE for L2 Early and Late Age of Acquisition in Experiment 1

	Early Age of Acquisition				Late Age of Acquisition			
	Word		Picture		Word		Picture	
	Rt	Acc.	Rt	Acc.	Rt	Acc.	Rt	Acc.
<b>Unrelated</b>	908	2,2	974	1,1	1122	1,7	1236	1,3
<b>Related</b>	931	1,6	950	1,5	1141	1,9	1206	1,4
<b>Sre</b>	-23		24		-29		30	

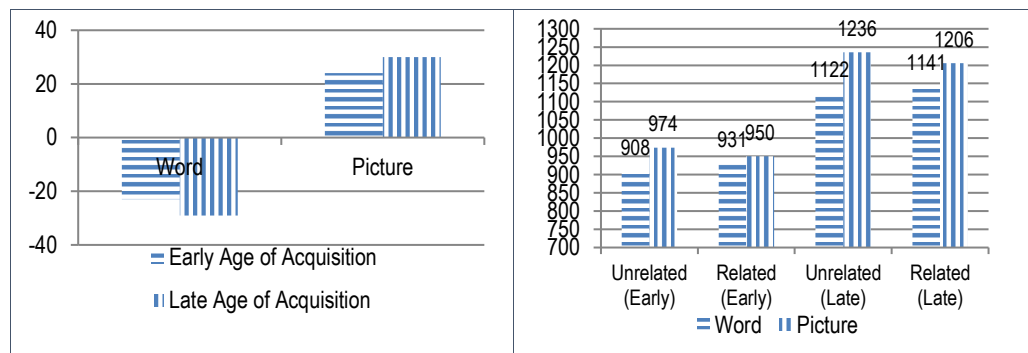


Figure 7. SRE and RTs (in ms. ) for L2 Early and Late Age of Acquisition in Experiment 1

The significant interactions gathered from paired samples statistics in Table 10 and 11 are in Pair 1 as word and picture and Pair 2 as related and unrelated context. First of all, for both groups, on the basis of context there was a significant main effect for bilinguals in early ( $t(43) = -2,169, p = 0,026, r=0,769$ ) and late age of acquisition ( $t(63) = -5,173, p = 0,000, r=0,785$ ). Similarly, in terms of relatedness, there was not any significant main effect between those in early age of acquisition ( $t(43) = -0,016 p = 0,987, r=0,767$ ) and late age of acquisition ( $t(63) = -0,368, p = 0,714, r=0,855$ ). Consequently, lexical selection and competition occur at conceptual level without inhibition of nontarget language.

Table 12. Paired Samples Statistics for Early Age of Acquisition in L2 in Experiment 1

Paired Samples Statistics				Paired Samples Correlation		
		Mean	N	Std. Deviation	Correlation	Sig.
<b>Pair 1</b>	<b>Word</b>	919,355	44	1403,000	0,769	0,000

		Mean	N	Std. Deviation	t	df	Sig. (2-tailed)
Pair 2	Picture	962,105	44	1364,651			
	Related	941,613	44	1367,907	0,767		0,000
	Unrelated	940,847	44	1417,000			
<b>Paired Samples T-test</b>							
<b>Paired Differences</b>							
		Mean	Std. Deviation	t	df	Sig. (2-tailed)	
Pair 1	Word - Picture	-3075,010	940,274	-2,169	43	0,026	
Pair 2	Related - Unrelated	-2340,450	951,095	-0,016	43	0,987	

Table 13. Paired Samples Statistics for Late Age of Acquisition in L2 in Experiment 1

		Mean	N	Std. Deviation	Paired Samples Correlation	
		Mean	N	Std. Deviation	Correlation	Sig.
Pair 1	Word	1131,121	64	1830,234	0,785	0,000
	Picture	1220,343	64	2230,126		
Pair 2	Related	1173,324	64	2120,542	0,855	0,000
	Unrelated	1178,450	64	2050,409		
<b>Paired Samples T-test</b>						
<b>Paired Differences</b>						
		Mean	Std. Deviation	t	df	Sig. (2-tailed)
Pair 1	Word -Picture	-895,092	1387,876	-5,173	63	0,000
Pair 2	Related-Unrelated	-518,403	1136,435	-0,368	63	0,714

#### 3. 4. 4 Multilingualism Factor and Lexical Access

To test the effect of the languages which known by participants except from English, the data obtained from the questionnaire was analyzed and the participants were grouped into two, bilinguals (N=31) and multilinguals (N=23). As described before, some English learners of Italian know and use French or Spanish (N=11), while some English learners Turkish know and use German or Arabic (N=12). Probably surprising fact is that bilinguals were slower than multilinguals in overall translation, context or relatedness. In can be immediately seen in Table 12 that multilinguals' RTs are so closer in context or relatedness; however, bilinguals had some difficulties in translation as expected in CSM hypothesis. Furthermore, multilinguals' SRE in word context (+2) is in positive way like picture context (+30) but different from bilinguals' SRE in word context (-44) (see Figure 7). Only analyzing these results one can say that multilinguals and bilinguals select the language at different levels. However, to get the objective results, independent and paired statistics should be analyzed.

Independent samples test results show that there is a significant main effect between the groups in the meaning of word ( $t(106) = 0,322, p = 0,000$ ), picture ( $t(106) = 0,261, p = 0,000$ ), related ( $t(106) = 0,472, p = 0,000$ ) and unrelated context ( $t(106) = 0,103, p = 0,000$ ). That shows that the RTs difference between the groups of bilinguals and multilinguals is meaningful; in other words bilinguals translated the target words in each position slower than multilinguals.

Table 14. Mean RTs (ms. ), Accuracy (in percent) and SRE for Multilinguals and Bilinguals in Experiment 1

	Multilinguals				Bilinguals			
	Word		Picture		Word		Picture	
	Rt	Acc.	Rt	Acc.	Rt	Acc.	Rt	Acc.
<b>Unrelated</b>	902	1,1	912	0,9	1128	1,3	1298	2,1
<b>Related</b>	900	1	882	0,7	1172	1,7	1274	1,6
<b>Sre</b>	2		30		-44		24	

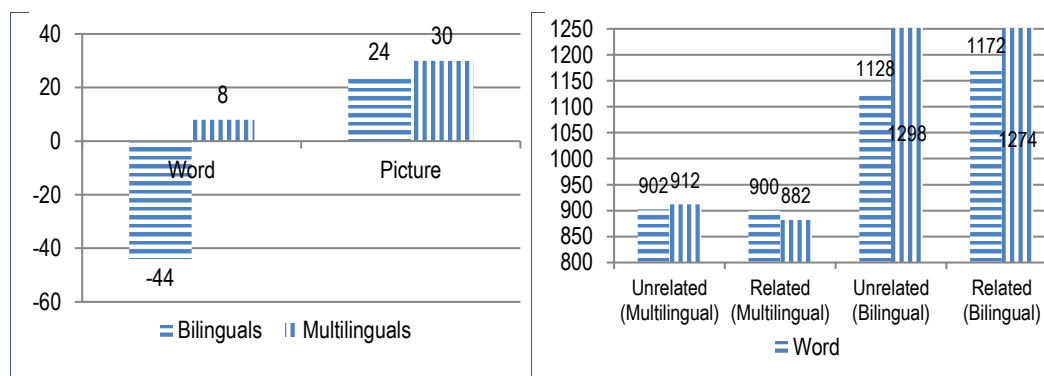


Figure 8. SRE and RTs (in ms) for Multilinguals and Bilinguals in Experiment 1

To analyze the main overall effect of multilingualism on language selection, bilinguals (in Table 13) and multilinguals (in Table 14) were divided into two groups and examined separately. Bilinguals support language selectivity in that locus of selection is at conceptual level since they have the similar results of CSM hypothesis explained at the beginning of the experiment for context ( $t(61) = -1,946, p = 0,004, r = 0,708$ ) and relatedness ( $t(61) = 0,223, p = 0,824, r = 0,710$ ). However, multilinguals statistics result shows that they are probably affected differently in lexical selection such as inhibition or suppression. Moreover, language production can be easier but the lexical selection process can be more difficult. As in the results, significant main effect in context ( $t(45) = -2,464, p = 0,795, r = 0,518$ ) and relatedness ( $t(45) = -2,377, p = 0,743, r = 0,548$ ) in multilinguals' responses have nothing in common with CSM results.

Table 15. Paired Samples Statistics for Bilinguals in Experiment 1

Paired Samples Statistics					Paired Samples Correlation	
Mean	N	Std. Deviation	Correlation	Sig.		

		Paired Differences				
		Mean	Std. Deviation	t	df	Sig. (2-tailed)
Pair 1	Word	1150,286	62	2379,291	0,708	0,000
	Picture	1286,042	62	2360,025		
Pair 2	Related	1223,233	62	2393,479	0,710	0,000
	Unrelated	1213,095	62	2366,952		

Table 16. Paired Samples Statistics for Multilinguals in Experiment 1

		Paired Differences			Paired Samples Correlation	
		Mean	N	Std. Deviation	Correlation	Sig.
Pair 1	Word	901,364	46	1884,248	0,518	0,000
	Picture	897,683	46	2530,586		
Pair 2	Related	891,365	46	2034,730	0,548	0,000
	Unrelated	907,378	46	2314,564		

#### 4. Experiment 2: Numeral Task

##### 4.1 Materials

Participants switched between their dominant language Italian or Turkish (L1) and English (L2). Numbers (from 0 to 9) were presented unpredictably. They chose the language of the response according to the color of the background (blue or yellow). All of the participants were instructed that "blue" indicated "respond in English" and "yellow" indicated "respond in Turkish or Italian". As in Costa & Santesteban (2004), there were two types of trials in which the language of response (either in L1 or L2) was either the same as the trial immediately before (nonswitch trial) or different than that used in the preceding trial (switch trials). These responses were produced in both L1 and L2 and there were four different types of trials: switch to L1, switch to L2, nonswitch in L1, nonswitch in L2. The total number of the trials in the experiment was 1000

(700 nonswitch trials (70%) and 300 switch trials (30%). There was the same number of production in L1 or L2 (500 responses for each language). Each number was presented 100 times during the experiment.

#### 4. 2 Procedure

The participants were tested individually in a soundproof room immediately after Experiment 1. As in the first experiment, in written and orally, they were asked to name the digits which were seen on the computer screen according to the background color of them. When the digits were seen in blue color they were expected to answer in L2, in yellow color they were expected to answer in L1. Each participant was given the numbers in a series of 100 digits. Each number appeared on the computer screen and remained for 800 ms. If the participant does not give any answer during this time, the next trial was seen on the screen and this procedure repeated until the end of the list, at which time an asterisk (\*) was presented for 1000 ms to show that the list finished and another one would begin in 1000ms. After each 10 lists, participants were given a break of approximately 5 minutes to prevent participants from overloading. All responses were recorded as in the first experiment and coded as "correct" or "incorrect".

#### 4. 3 Data Analysis

Response latencies of only correct responses (in L1 or L2) were included in the statistical analyses. There are two main variables as L1-L2 or switch-nonswitch contexts. The analyses were conducted to each bilingual group separately as mentioned in Experiment 1.

#### 4. 4 Results and Discussion

Numeral task including language switches was conducted to observe whether lexical access and language selection occur at lexical level or not. Recall that IC model hypothesize the words in the nontarget language are inhibited to produce of the target language because there is difference in the size of L1 and L2, in other words L1 system is larger than L2 system so L1 must be reactivated. That is the reason why more time is needed when switching into larger one of two systems. Previous researchers (Costa & Santesteban, 2004; Meuter, 1994; Meuter & Allport, 1999) claimed that asymmetric switch cost (ASC) is associated with L1 and L2 switches and in the present experiment RTs of language (L1 and L2) and trial type (switch and nonswitch) performances were analyzed separately. This experiment is also important to understand the factors which have been consisted in CSM and Word Translation Task to see the main effect of this difference between participants in terms of L2 proficiency level and multilingualism. As in Table 15, the RTs results show that regardless of the factors, all bilinguals were slower in naming the switch trials than nonswitch trials. Also, they were slower in naming L1 trials than L2 trials. Furthermore there was a significant effect for response language (L1 and L2) ( $t(107) = 6,801, p = 0,000, r = 0,697$ ) and trial type (switch and nonswitch) ( $t(107) = 7,943, p = 0,000, r = 0,743$ ). It can be understood from the statistics that switching to L1 is more difficult than switching to L2 and ASC for switch trials is more than nonswitch trials.

Table 17. Paired Samples Statistics for Language Response (L1 or L2) and Trial Types (switch-nonswitch) in Experiment 2

Paired Samples Statistics		Mean	N	Std. Deviation	Paired Samples Correlation	
					Correlation	Sig.
Pair 1	L1	659,422	108	1271,646	0,697	0,000
	L2	597,942	108	1109,985		

Pair 2	Switch	661,959	108	1288,924	0,743	0,000
	Nonswitch	595,405	108	1074,728		
<b>Paired Differences</b>						
		<b>Mean</b>	<b>Std. Deviation</b>	<b>t</b>	<b>df</b>	<b>Sig. (2-tailed)</b>
Pair 1	L1 - L2	61480,18	93945,09	6,801	107	0,000
Pair 2	Switch - Nonswitch	66553,92	87079,64	7,943	107	0,000

#### 4. 4. 1 L1 Factor and Lexical Access

One of the main aims of this experiment is to see whether L1 factor affects the locus of language selection and completion during bilingual speech production. To analyze this factor, participants are grouped into two; English learners of Italian and English learners of Turkish. The mean reaction times gathered from the experiment show that switch trials take longer than nonswitch trials and Italian participants' RTs are more than Turkish participants' (see Table 16 and for graph see Figure 8).

In language response and trial type observation, there is a significant main effect between L1 Turkish and Italian participants. According to the independent samples test results, there is a significant main effect between two groups on the basis of L1 ( $t(95,8) = -3,929, p = 0,000$ ), L2 ( $t(106) = -2,643, p = 0,009$ ), switch ( $t(96,416) = -3,383, p = 0,001$ ) and nonswitch ( $t(106) = -3,294, p = 0,001$ ) trials.

Table 18. Mean RTS (ms. ), Accuracy (in percent) and ASC for L2 learners of Italian and Turkish in Experiment 2

	L1 Italian				L1 Turkish			
	L1		L2		L1		L2	
	Rt	Acc.	Rt	Acc.	Rt	Acc.	Rt	Acc.
<b>Switch</b>	740	0,7	666	0,2	660	0,6	580	0,5
<b>Nonswitch</b>	672	0,8	586	0,7	574	0,5	558	0,4
<b>Asc</b>	68		80		86		22	

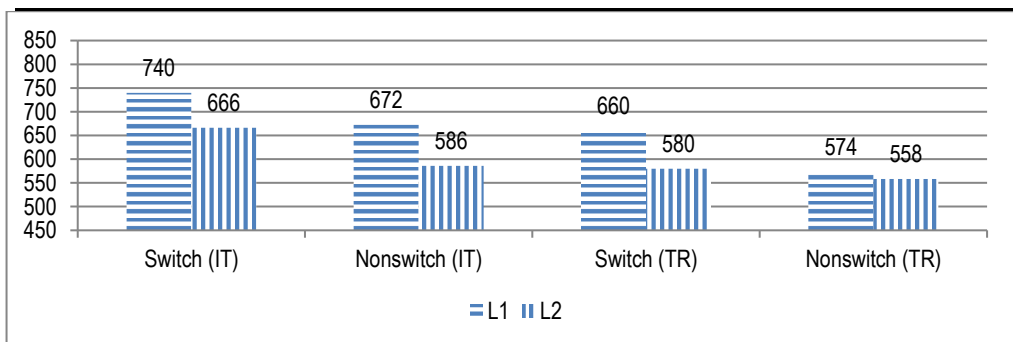


Figure 9. RTs (in ms. ) for L2 learners of Italian and Turkish in Experiment 2

To analyze the main effect of the switch or nonswitch trials, L1 Turkish and L1 Italian participants are examined separately with paired samples statistics (as in Table 17 and 18). The language response and trial type data are obtained from each group and the RTs show that the results of both group are similar to each other in terms of "language response" for L1 Turkish ( $t(55) = 4,279$ ,  $p = 0,000$ ,  $r = 0,742$ ) and L1 Italian ( $t(51) = 5,413$ ,  $p = 0,000$ ,  $r = 0,626$ ). Similarly, the "trial type responses" are similar to each other because there is a significant main effect between switch and nonswitch trials for L1 Turkish ( $t(55) = 6,681$ ,  $p = 0,000$ ,  $r = 0,803$ ) and L1 Italian ( $t(51) = 5,117$ ,  $p = 0,000$ ,  $r = 0,652$ ) groups. Consequently, similar effects can be seen for both groups and the results support ICM regardless of what type of bilingual one may be. That is, locus of language selection and lexical access process are solved at lexical level as long as language switching is needed in production of target language.

Table 19. Paired Samples Statistics for L2 Learners of Turkish in Experiment 2

Paired Samples Statistics		Paired Samples Correlation				
		Mean	N	Std. Deviation	Correlation	Sig.
Pair 1	L1	617,575	56	1034,706	0,742	0,000
	L2	569,466	56	1104,983		
Pair 2	Switch	620,046	56	1074,538	0,803	0,000
	Nonswitch	566,995	56	1028,838		
Paired Samples T-test		Paired Differences				
		Mean	Std. Deviation	t	df	Sig. (2-tailed)
Pair 1	L1 - L2	44109,52	77141,57	4,279	55	0,000
Pair 2	Switch - Nonswitch	59050,02	66139,71	6,681	55	0,000

Table 20. Paired Samples Statistics for L2 learners of Italian in Experiment 2

Paired Samples Statistics		Paired Samples Correlation				
it		Mean	N	Std. Deviation	Correlation	Sig.
Pair 1	L1	706,641	52	1341,522	0,626	0,000
	L2	626,454	52	1052,766		
Pair 2	Switch	703,865	52	1376,593	0,652	0,000
	Nonswitch	629,230	52	1028,013		
Paired Samples T-test		Paired Differences				
		Mean	Std. Deviation	t	df	Sig. (2-tailed)



		Mean	Std. Deviation	t	df	Sig. (2-tailed)
Pair 1	L1 - L2	801,870	1068,220	5,413	51	0,000
Pair 2	Switch - Nonswitch	746,350	1051,816	5,117	51	0,000

#### 4. 4. 2 L2 Proficiency Level Factor and Lexical Access

As in the first experiment, the participants were categorized into two according to L2 proficiency level; low and highly proficient bilinguals. As expected, mean reaction times show highly proficient bilinguals are faster than low proficient ones. However, as Table 19 illustrates, ASC in L1 and L2 for low proficient bilinguals (117 ms. , 64 ms. respectively) is much more than highly proficient bilinguals' cost (47 ms. , 38 ms. ) (Figure 9 shows more detailed graph). These findings are important because they do not validate the hypotheses of ICM and support the findings found in Experiment 1. From these results, it can be assumed that in order to select the appropriate word in the target language, low proficient bilinguals must inhibit the nonrelevant language temporarily.

According to the independent samples test, there is a significant main effect between two groups in terms of L1 ( $t(95,8) = 6,484, p=0,000$ ), L2 ( $t(106) = 6,863, p=0,000$ ), switch ( $t(106) = 7,222, p=0,000$ ) and nonswitch trials ( $t(106) = 6,181, p=0,000$ ). Analyzing these results it can be assumed that low proficient bilinguals are slower than highly proficient bilinguals as expected. However, to get knowledge about what the main difference between them, separate analyses with paired samples test are needed.

Table 21. Mean RTs (ms. ), Accuracy (in percent) and ASC for L2 Low and Highly Proficient Bilinguals in Experiment 2

	L2 Low Proficiency				L2 High Proficiency			
	L1		L2		L1		L2	
	Rt	Acc.	Rt	Acc.	Rt	Acc.	Rt	Acc.
Switch	796	0,8	696	0,3	604	0,6	550	0,4
Nonswitch	679	0,7	632	0,7	557	0,6	512	0,4
Asc	117		64		47		38	

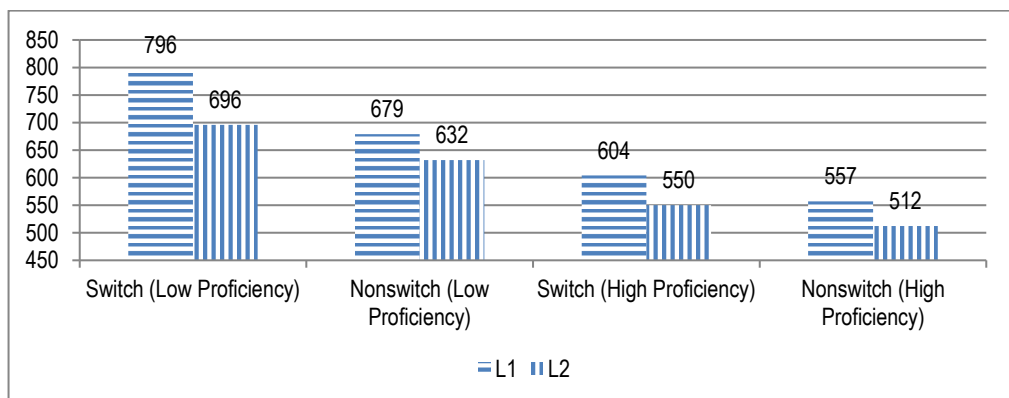


Figure 10. RTs (in ms. ) for L2 Low and Highly Proficient Bilinguals in Experiment 2

Paired samples statistics are shown in Table 20 and 21 separately. They are analyzed for the same reason in the first experiment and there are several significant interactions in the results. Most importantly, for language response and trial types, only low proficient bilinguals could get the significant effect for language response ( $t(53) = 4,595$ ,  $p = 0,000$ ,  $r = 0,526$ ) and for trial types ( $t(53) = 4,541$ ,  $p = 0,000$ ,  $r = 0,611$ ). These results are also parallel to the results of ICM itself (Green, 1998) which has been found at the beginning of the study. Alike low proficient bilinguals, highly proficient bilinguals could not get the significant effect for both language response ( $t(53) = 1,862$ ,  $p = 0,068$ ,  $r = 0,831$ ) and trial types ( $t(53) = 2,159$ ,  $p = 0,064$ ,  $r = 0,721$ ). The results of the present experiment for low proficient bilinguals are completely in line with the claims put forth by ICM and the inhibition rules to produce target language. On the other hand, the same discussion is not possible for highly proficient bilinguals in the shadow of their asymmetric switch cost; in other words, highly proficient bilinguals are completely in line with CSM and they select language at conceptual level using language cues in preverbal message.

Table 22. Paired Samples Statistics for L2 Low Proficient Bilinguals in Experiment 2

Paired Samples Statistics					Paired Samples Correlation	
		Mean	N	Std. Deviation	Correlation	Sig.
Pair 1	L1	737,876	54	1193,714	0,526	0,000
	L2	664,222	54	1000,946		
Pair 2	Switch	746,632	54	1165,801	0,611	0,000
	Nonswitch	655,466	54	965,099		
Paired Samples T-test						
Paired Differences						
		Mean	Std. Deviation	t	df	Sig. (2-tailed)
Pair 1	L1 - L2	676,537	1082,010	4,595	53	0,000
Pair 2	Switch – Nonswitch	851,661	956,835	6,541	53	0,000

Table 23. Paired Samples Statistics for L2 Highly Proficient Bilinguals in Experiment 2

Paired Samples Statistics					Paired Samples Correlation	
		Mean	N	Std. Deviation	Correlation	Sig.
Pair 1	L1	580,968	54	955,273	0,831	0,000
	L2	531,402	54	1014,424		
Pair 2	Switch	577,285	54	942,799	0,721	0,000
	Nonswitch	534,121	54	888,809		

**Paired Samples T-test**

		Paired Differences				
		Mean	Std. Deviation	t	df	Sig. (2-tailed)
Pair 1	L1 - L2	1456,587	574,961	1,862	53	0,068
Pair 2	Switch - Nonswitch	2016,394	686,457	2,159	53	0,064

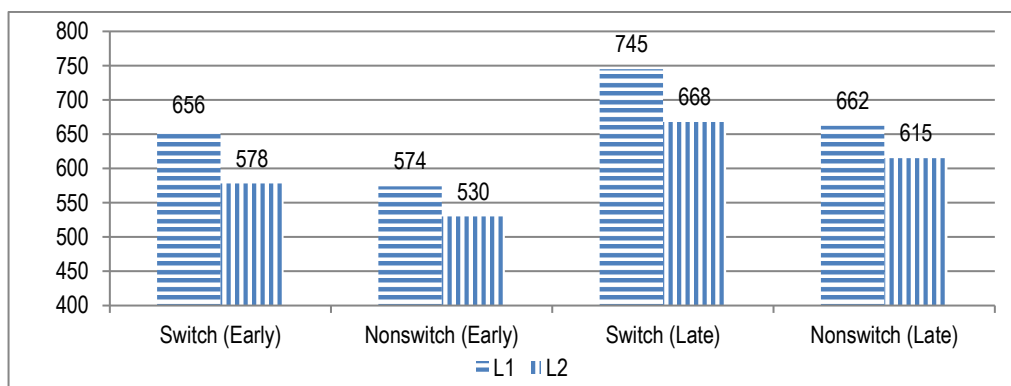
**4. 4. 3 L2 Age of Acquisition Factor and Lexical Access**

As was emphasized in L2 Age of Acquisition Factor and Language Selection section of Experiment 1, all participants were grouped into two, L2 early and late age of acquisition. As expected, those in early age of acquisition were faster than those in late age of acquisition. However, as shown in Table 22, their ASC rate is similar to each other, as for L1: 82ms. to 83ms. (early and late age of acquisition respectively) and for L2: 48ms. to 53ms. (also see Figure 10). From these results, it is obvious to predict that all bilinguals regardless of their L2 age of acquisition proceeds their lexical selection via ICM hypothesis. In other words, they use inhibitory control mechanisms in selection target language as long as they do language switching.

Age of acquisition independent samples analyses also show that there was an overall main effect for L1 ( $t(106) = -3,014, p=0,003$ ), L2 ( $t(106) = -3,404, p=0,001$ ), switch ( $t(106) = -2,980, p=0,004$ ) and nonswitch ( $t(106) = -3,516, p=0,001$ ) trials. To analyze the main overall effect of language response and trial types, both groups must be indicated separately.

Table 24. Mean RTs (ms. ), Accuracy (in percent) and ASC for L2 Early and Late Age of Acquisition in Experiment 2

	Early Age of Acquisition				Late Age of Acquisition			
	L1		L2		L1		L2	
	Rt	Acc.	Rt	Acc.	Rt	Acc.	Rt	Acc.
<b>Switch</b>	656	0,8	578	0,1	745	0,6	668	0,3
<b>Nonswitch</b>	574	0,8	530	0,9	662	0,7	615	0,4
<b>Asc</b>	82		48		83		53	

**Figure 11.** RTs (in ms. ) for L2 Early and Late Age of Acquisition in Experiment 2

The magnitude interactions obtained from paired samples statistics (in Table 23 and 24) are as follows: First, there was an observed main effect in response language for those in not only early age of acquisition ( $t(41) = 5,252$ ,  $p = 0,000$ ,  $r = 0,811$ ) but also late age of acquisition ( $t(65) = 4,811$ ,  $p = 0,000$ ,  $r = 0,562$ ). Second, the last observed significant main effect can be analyzed from the part of trial types and both the participants who are at early age of acquisition ( $t(41) = 5,372$ ,  $p = 0,000$ ,  $r = 0,799$ ) and late age of acquisition ( $t(65) = 5,914$ ,  $p = 0,000$ ,  $r = 0,657$ ) get similar results. The findings from these analyses suggest that L2 age of acquisition does not affect the locus of language selection and competition. Surprisingly, although they are totally different from each other in nature their statistics are similar except from the time they needed to name the digits in target language.

Table 25. Paired Samples Statistics for L2 Early Age of Acquisition in Experiment 2

		Paired Samples Statistics			Paired Samples Correlation	
		Mean	N	Std. Deviation	Correlation	Sig.
Pair 1	L1	614,849	42	1228,812	0,811	0,000
	L2	554,465	42	1189,993		
Pair 2	SWITCH	617,251	42	1303,556	0,799	0,000
	NONSWITCH	552,063	42	1093,575		
		Paired Samples T-test				
		Paired Differences				
		Mean	Std. Deviation	t	df	Sig. (2-tailed)
Pair 1	L1 - L2	603,843	745,157	5,252	41	0,000
Pair 2	Switch - Nonswitch	651,882	786,445	5,372	41	0,000

Table 26. Paired Samples Statistics for L2 Late Age of Acquisition in Experiment 2

		Paired Samples Statistics			Paired Samples Correlation	
		Mean	N	Std. Deviation	Correlation	Sig.
Pair 1	L1	703,786	66	1224,523	0,562	0,000
	L2	641,609	66	966,999		
Pair 2	Switch	706,409	66	1204,832	0,657	0,000

		Nonswitch	638,986	66	973,863		
Paired Samples T-test							
Paired Differences							
		Mean	Std. Deviation	t	df	Sig. (2-tailed)	
Pair 1	L1 - L2	621,775	1049,988	4,811	65	0,000	
Pair 2	Switch - Nonswitch	674,229	926,245	5,914	65	0,000	

#### 4. 4. 4 Multilingualism Factor and Lexical Access

In the light of diverse language histories and background, the participants who knew and used other languages except from English were separated from those who knew and used only English as L2 as explained in Experiment 1. Alike word translation task, the multilinguals were slower in naming digits than bilinguals in numeral task. Moreover, as Table 25 illustrates asymmetric switch cost shows that multilinguals needed more time (ASC=115 ms. ) switching from L2 to L1 than bilinguals needed (ASC. =49 ms. ). The same effect can be seen in L2 asymmetric switch cost (also see Figure 11). The analyses present the effects of certain factors on the nature of multilinguals such as inhibition effect of the other language (L3). To be sure on this hypothesis, it will be suggested to obtain data from two groups first comparatively and then separately. Independent samples test results suggest that there is a significant main effect between participants in terms of L1 ( $t(106) = -3,481, p=0,001$ ), L2 ( $t(106) = -5,228, p=0,000$ ), switch ( $t(106) = -4,214, p=0,000$ ) and nonswitch ( $t(106) = -4,391, p=0,000$ ) trials. That shows that bilinguals are faster in naming digits than multilinguals.

Table 27. Mean RTs (ms. ), Accuracy (in percent) and ASC for Multilinguals and Bilinguals in Experiment 2

	Multilinguals				Bilinguals			
	L1		L2		L1		L2	
	Rt	Acc.	Rt	Acc.	Rt	Acc.	Rt	Acc.
Switch	777	0,3	677	0,4	623	0,5	569	0,5
Nonswitch	662	0,6	610	0,2	574	0,7	534	0,4
Asc	115		67		49		35	

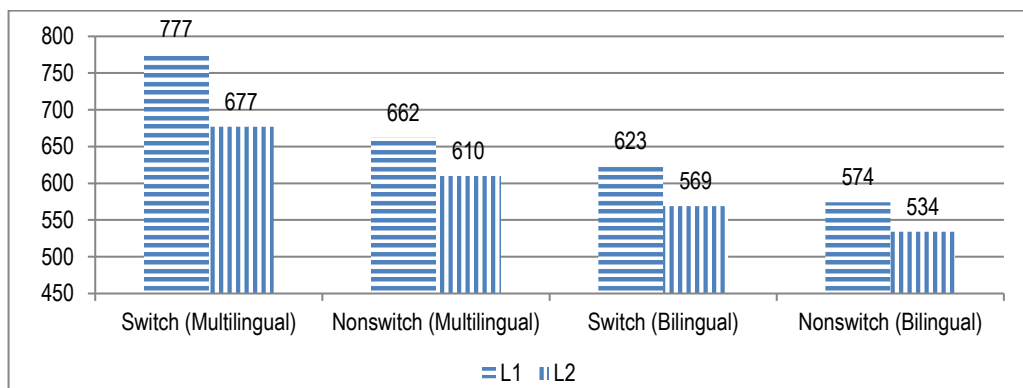


Figure 12. RTs (in ms) for Multilinguals and Bilinguals in Experiment 2

Main overall effect of multilingualism in language selection and lexical access process should be considered as significant. Since, only indicating the RTs and ASCs, one may predict, multilinguals are affected from different process during the language selection. Also, one may ask why multilinguals had difficulty in naming digits instead of being fast because of the proficiency levels. The answer to this question is coming from IC model; because the inhibitory control mechanisms prevent them producing the language at conceptual level but lexical level and that is the reason why switching from L2 to L1 is more difficult than L1 to L2 when they are compared with bilinguals. The paired samples results shown in Table 26 and 27 say that there is a significant main effect in language response ( $t(45) = 1,973, p = 0,021, r = 0,737$ ) and trial types ( $t(45) = 2,391, p = 0,015, r = 0,476$ ) in multilinguals' responses. However, we cannot see the significant main effect in bilinguals language responses ( $t(61) = 6,032, p = 0,065, r = 0,637$  and trial types ( $t(61) = 5,860, p = 0,074, r = 0,705$ ). Finally, these analyses suggest that multilinguals use inhibitory control during lexical selection and that bilinguals do not.

Table 28. Paired Samples Statistics for Bilinguals in Experiment 2

Paired Samples Statistics				Paired Samples Correlation		
		Mean	N	Std. Deviation	Correlation	Sig.
Pair 1	L1	598,501	62	1163,691	0,637	0,000
	L2	551,852	62	888,780		
Pair 2	Switch	596,097	62	1126,700	0,705	0,000
	Nonswitch	554,256	62	965,950		
Paired Samples T-test				Eşleştirilmiş Fark		
		Mean	Std. Deviation	t	df	Sig. (2-tailed)
Pair 1	L1 - L2	696,493	909,148	6,032	61	0,065
Pair 2	Switch - Nonswitch	608,409	817,477	5,860	61	0,074

Table 29. Paired Samples Statistics for Multilinguals in Experiment 2

**Paired Samples Statistics**

		Mean	N	SS	Paired Samples Correlation	
					Correlation	Sig.
Pair 1	L1	719,227	46	1192,693	0,737	0,000
	L2	643,845	46	1106,681		
Pair 2	Switch	727,598	46	1148,655	0,476	0,000
	Nonswitch	636,126	46	1029,037		

**Paired Samples T-test**

		Paired Differences				
		Mean	Std. Deviation	t	df	Sig. (2-tailed)
Pair 1	L1 - L2	2438,26	838,343	1,973	45	0,021
Pair 2	Switch - Nonswitch	3947,143	1119,628	2,391	45	0,015

**5. Conclusion and Suggestion**

The answer to the question whether basic factors such as L1, L2 proficiency level, L2 age of acquisition and multilingualism affect the locus of language selection and lexical access process is tried to be given in this study. After the analyses, it can be concluded that while more proficient learners provide support for CSM, less proficient learners provide support for ICM for the first experiment. Besides, multilingual speakers provide support for ICM bilingual speakers provide support for CSM for the second experiment. Finally, it can be proposed that language selection and competition differ according to the some basic factors such as L2 proficiency level and multilingualism and these are the determining factor in the locus of language selection during lexical access (Demiray, 2014).

Based on this general conclusion, in figure 12, Language Selection by L2 Proficiency and Multilingualism Model has been proposed. In this model, English learner of Italian is shown the concept "chair" and expected to name it in L1. When target language is produced, if L2 proficiency level is high, semantic system will immediately activate lexical nodes of target language in preverbal message; however lexical nodes of nontarget language will not be activated. Thus, language selection occurs within target language only using one lexicon without competition for selection across languages. On the other hand, if L2 proficiency level of the participant is low, inhibitory control mechanisms will be involved in language selection. Nontarget language lexicon will compete for selection with target language lexicon at lexical level. In other words, the higher L2 proficiency is, the more language selection occurs at conceptual level. However, if the participant is multilingual, the inhibition occurring at lexical level will be stronger and response time will be longer.

Whatever L3 proficiency level is, the multilingual will go into production of target language at lexical level and lexicons for each language will compete with each other and finally the more highly activated lexicon will be the winner. As in figure 12, the higher English learner of Italian participant's L2 proficiency level is, the more he/she will shift to conceptual level from lexical level (follow arrows in figure). If this participant has L3 knowledge, inhibitory control mechanisms get on the stage, lexicons and the lexical nodes regarding L2 (English) and L3 (Spanish) are suppressed and the language production in L1 (Italian) occurs in a higher cost.

The statistical analyses of two experiments questioned whether the findings of previous research (Costa & Santesteban, 2004; La Heij, 2004; Meuter & Allport, 1999 and Schwieter, 2007) can be generalized to late bilinguals or multilinguals who have different language backgrounds. Finally, it was seen that language selection at conceptual or lexical level differs depending on L2 Proficiency Level (as in Costa & Santesteban, 2004 and Schwieter, 2007) and Multilingualism.

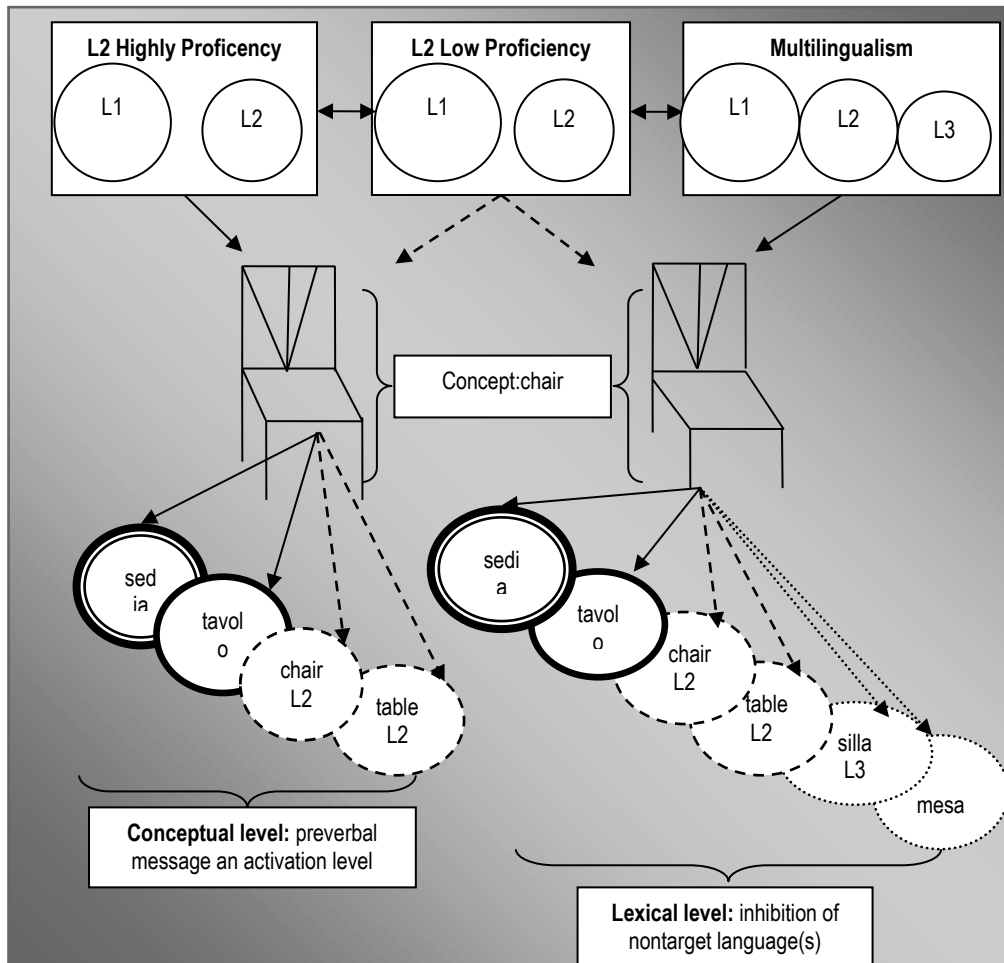


Figure 14. Language Selection by L2 Proficiency and Multilingualism Model

## References

- Allan, D. (1992). *The Oxford Placement Test*. Oxford: Oxford University Press.
- Bloem, L. , and La Heij, W. (2003). Semantic facilitation and semantic interference in word translation: Implications for models of lexical access in language production. *Journal of Memory and Language*, 48, p. 468-488.
- Caramazza, A. (1997). How many levels of processing are there in lexical access? *Cognitive Neuropsychology*, 14 (1), p. 177-208.
- Costa, A. (2005). Lexical access in bilingual production. In J. F. Kroll and A. M. B. de Groot (Eds. ), *Handbook of bilingualism: Psycholinguistic approaches* (p. 308-325). New York: Oxford.



Costa, A. and Santesteban, M. (2004). Lexical access in bilingual speech production: Evidence from language switching in highly proficient bilinguals and L2 learners. *Journal of Memory and Language*, 50, p. 491-511.

Costa, A. , Miozzo, M. , and Caramazza, A. (1999). Lexical selection in bilinguals: Do words in the bilinguals' two lexicons compete for selection? *Journal of Memory and Language*, 41,p. 365-397.

De Bot, K. (1992). A bilingual production model: Levelt's speaking model adapted. *Applied Linguistics*, 13, p. 1-24.

Demiray, F. (2014). *Language Selectivity in Lexical Access: An Experimental Study on Bilinguals*. Unpublished *Phd Dissertation*, Ankara University Social Sciences Institute. Ankara.

Fishman, J. A. (2001). 300-plus years of heritage language education in the United States. In J. K. Peyton, D. A. Ranard, and S. McGinnis (Eds. ), *Heritage languages in America: Preserving a national resource* (p. 81-97). Washington, DC and McHenry, IL: Center for Applied Linguistics and Delta Systems.

Francis S. W. (2000). *Bilingual Semantic and Conceptual Representation*. The University of Texas: El Paso.

Green, D. W (1998). Mental control of the bilingual lexico-semantic system. *Bilingualism: Language and Cognition*, 1,p. 67-81.

Kroll, J. , Bobb, S. , and Wodniecka, Z. (2006). Language selectivity is the exception, not the rule: Arguments against a fixed locus of language selection in bilingual speech. *Bilingualism: Language and Cognition*, 9 (2), p. 119-135.

Kroll, J. F. ,and De Groot, A. M. B. (1997). Lexical and conceptual memory in the bilingual. A. M. B. De Groot, and J. F. Kroll (Eds. ) In, *Tutorials in bilingualism: Psycholinguistic perspectives* (p. 169-199). Mahwah, NJ: Lawrence Erlbaum Associates.

Kroll, J. F. , and Stewart, E. (1994). Category interference in translation and picture naming: Evidence for asymmetric connections between bilingual memory representations. *Journal of Memory and Language*, 33, p. 149-174.

La Heij, W. (2005). Selection processes in monolingual and bilingual lexical access. In J. F. Kroll and A. M. B. de Groot (Eds. ),*Handbook of bilingualism: Psycholinguistic approaches* (p. 289-307). New York: Oxford.

Levelt, W. J. M. (2001). Spoken word production: A theory of lexical access. *Proceedings of the National Academy of Sciences*, 98, p. 13464-13471.

Marian, F. , Blumenfeld, H. , and Kaushanskaya, M. (2007). The Language Experience and Proficiency Questionnaire (LEAP-Q): Assessing Language Profiles in Bilinguals and Multilinguals: *Journal of Speech, Language, and Hearing Research*, Vol. 50, p. 940-967.

Meuter, R. F. I. , and Allport, A. (1999). Bilingual language switching in naming: Asymmetrical costs of language selection. *Journal of Memory and Language*, 40, p. 25-40.

Schwieter, J. (2007). A psycholinguistic investigation of language selectivity in bilingual speech production. *Phd Dissertation*, 68 (9), Florida University. (UMI No. 3282661).

## Appendix A

### Target words and stimuli used in Experiment 1 for L1 Turkish Participants

Target Word	Translation (produced)	Related Context (picture or word distracter)		Unrelated Context (picture or word distracter)	
Pig	Domuz	Keçi	Goat	Cetvel	Ruler
Horse	At	Inek	Cow	Çorap	Sock
Duck	Ördek	Tavuk	Chicken	Sepet	Basket

Donkey	Eşek	Zebra	<i>Zebra</i>	Araba	<i>Car</i>
Dog	Köpek	Kedi	<i>Cat</i>	Şeftali	<i>Peach</i>
Deer	Geyik	Bufalo	<i>Buffalo</i>	Bluz	<i>Blouse</i>
Tree	Ağaç	Yaprak	<i>Leaf</i>	Dudak	<i>Lips</i>
Frog	Kurbağa	Salyangoz	<i>Snail</i>	Kol	<i>Arm</i>
Ant	Karıncı	Örümcek	<i>Spider</i>	Kapı	<i>Door</i>
Shark	Köpekbalığı	Yunus	<i>Dolphin</i>	Zincir	<i>Chain</i>
Plane	Uçak	Tren	<i>Train</i>	Burun	<i>Nose</i>
Garlic	Sarımsak	Soğan	<i>Onion</i>	Ceket	<i>Coat</i>
Grapes	Üzüm	Limon	<i>Lemon</i>	Yunus	<i>Dolphin</i>
Rabbit	Tavşan	Sincap	<i>Squirrel</i>	Limon	<i>Lemon</i>
Cherry	Kiraz	Elma	<i>Apple</i>	Zebra	<i>Zebra</i>
Orange	Portakal	Şeftali	<i>Peach</i>	Kedi	<i>Cat</i>
Ear	Kulak	Dudak	<i>Lips</i>	Solucan	<i>Snail</i>
Spoon	Kaşık	Çatal	<i>Fork</i>	Sincap	<i>Squirrel</i>
Scissors	Makas	Cetvel	<i>Ruler</i>	Yaprak	<i>Leaf</i>
Glove	Eldiven	Çorap	<i>Sock</i>	Tavuk	<i>Chicken</i>
Saw	Testere	Çekiç	<i>Hammer</i>	Elma	<i>Apple</i>
Knife	Bıçak	Balta	<i>Axe</i>	Tren	<i>Train</i>
Trousers	Pantolon	Hırka	<i>Cardigan</i>	Inek	<i>Cow</i>
Dress	Elbise	Bluz	<i>Blouse</i>	Keçi	<i>Goat</i>
Skirt	Etek	Ceket	<i>Coat</i>	Çekiç	<i>Hammer</i>
Rope	Halat	Zincir	<i>Chain</i>	Örümcek	<i>Spider</i>
Leg	Ayak	Kol	<i>Arm</i>	Soğan	<i>Onion</i>
Eye	Göz	Burun	<i>Nose</i>	Balta	<i>Axe</i>
Bike	Bisiklet	Araba	<i>Car</i>	Divan	<i>Couch</i>
Suitcase	Valiz	Sepet	<i>Basket</i>	Çatal	<i>Fork</i>
Window	Pencere	Kapı	<i>Door</i>	Hırka	<i>Cardigan</i>
Chair	Sandalye	Divan	<i>Couch</i>	Bufalo	<i>Buffalo</i>

## Appendix B

### Target words and stimuli used in Experiment 1 for L1 Italian Participants

Target Word	Translation (produced)	Related Context (picture or word distracter)		Unrelated Context (picture or word distracter)	
Pig	Maiale	Capra	<i>Goat</i>	Righello	<i>Ruler</i>
Horse	Cavallo	Mucca	<i>Cow</i>	Calzino	<i>Sock</i>
Duck	Anatra	Pollo	<i>Chicken</i>	Cestino	<i>Basket</i>
Donkey	Asino	Zebra	<i>Zebra</i>	Macchina	<i>Car</i>
Dog	Cane	Gatto	<i>Cat</i>	Pesca	<i>Peach</i>
Deer	Cervo	Bufalo	<i>Buffalo</i>	Camicetta	<i>Blouse</i>
Tree	Albero	Foglia	<i>Leaf</i>	Labbro	<i>Lips</i>
Frog	Rana	Lumaca	<i>Snail</i>	Braccio	<i>Arm</i>
Ant	Formica	Ragno	<i>Spider</i>	Porta	<i>Door</i>
Shark	Squalo	Delfino	<i>Dolphin</i>	Catena	<i>Chain</i>
Plane	Aereo	Treno	<i>Train</i>	Naso	<i>Nose</i>
Garlic	Aglio	Cipolla	<i>Onion</i>	Cappotto	<i>Coat</i>
Grapes	Uva	Limone	<i>Lemon</i>	Delfino	<i>Dolphin</i>
Rabbit	Coniglio	Scoiattolo	<i>Squirrel</i>	Limone	<i>Lemon</i>
Cherry	Ciliegia	Mela	<i>Apple</i>	Zebra	<i>Zebra</i>
Orange	Arancione	Pesca	<i>Peach</i>	Gatto	<i>Cat</i>
Ear	Orecchio	Labbro	<i>Lips</i>	Lumaca	<i>Snail</i>
Spoon	Cucchiaio	Forchetta	<i>Fork</i>	Scoiattolo	<i>Squirrel</i>
Scissors	Forbici	Righello	<i>Ruler</i>	Foglia	<i>Leaf</i>
Glove	Guanto	Calzino	<i>Sock</i>	Pollo	<i>Chicken</i>
Saw	Sega	Martello	<i>Hammer</i>	Mela	<i>Apple</i>
Knife	Coltello	Ascia	<i>Axe</i>	Treno	<i>Train</i>
Trousers	Pantaloni	Cardigan	<i>Cardigan</i>	Mucca	<i>Cow</i>
Dress	Vestire	Camicetta	<i>Blouse</i>	Capra	<i>Goat</i>
Skirt	Gonna	Cappotto	<i>Coat</i>	Martello	<i>Hammer</i>
Rope	Corda	Catena	<i>Chain</i>	Ragno	<i>Spider</i>
Leg	Gamba	Braccio	<i>Arm</i>	Cipolla	<i>Onion</i>
Eye	Occhio	Naso	<i>Nose</i>	Ascia	<i>Axe</i>
Bike	Bicicletta	Macchina	<i>Car</i>	Divano	<i>Couch</i>
Suitcase	Valigia	Cestino	<i>Basket</i>	Forshetta	<i>Fork</i>

---

Window	Finestra	Porta	<i>Door</i>	Cardigan	<i>Cardigan</i>
Chair	Sedia	Divano	<i>Couch</i>	Bufalo	<i>Buffalo</i>

---

## Education Challenges and Developments in Foreign Language Teaching in Croatian Law Schools Education Challenges and Development for the Future

Ljubica Kordić

University of Osijek, Faculty of Law, Croatia

Assistant Professor is at present the Head of the Department of Foreign Languages at the Faculty of Law, University of Osijek, Croatia. <sup>1</sup>

### Abstract

*In the modern world of global economic and political associations, the knowledge of foreign languages and communication skills represent essential factors in all professions. In this respect, knowledge of English language as lingua franca of international communication is an indispensable prerequisite for communication within the legal profession worldwide. This paper is a case-study of teaching foreign languages in Croatian Law Schools, presented on the case of the Faculty of Law, University of Osijek. In the introductory part of the paper, a short description of the status and the position of foreign language courses in the Higher Education System of the Republic of Croatia is offered. In the main part the author presents new developments in the foreign language teaching in Croatian law faculties as answers to current challenges of Croatian membership in the EU. On the example of the Faculty of Law, University of Osijek, new projects on teaching foreign languages to practicing lawyers and law students are presented, with an emphasis on the Lifelong Learning Programme for Lawyer-Linguists. This programme, as well as specific foreign language courses in Legal English, Legal German and Legal French, have been developed within the lifelong education projects for lawyers, by which young lawyers are offered an opportunity to learn and/or to improve their knowledge of the three working languages of the EU. These developments in foreign language teaching within the Croatian Higher Education System are one of the responses to current challenges of the internationalization of the modern world.*

**Keywords:** *foreign languages, international communication, lifelong learning programmes, law schools, lawyer-linguists*

### 1. Introduction

The modern world is characterized by the globalization process, which is defined as the “widening, deepening and speeding up of worldwide interconnectedness” (Held, McGrew, Goldblatt and Perraton, 1999). This process has been brought about by the trends of population mobility and especially by developments in information and communication technologies, which enable establishing instantaneous links all over the world. In the new globalized world communication has taken its central facilitative role. These changes of the modern world have highlighted the importance of foreign languages and brought new requirements and challenges for foreign language teachers. With mobility being one of the main principles of the new Europe, young people need to be proficient in languages of wider communication, especially of English as lingua franca of international communication. Various EU and Council of Europe documents and reports stress the importance of learning languages and put forward multilingualism as one of the highly appreciated values of modern European society.

In the introductory part of this paper, the status of LSP in the Croatian Higher Education System will be briefly described. New developments in LSP teaching will be analysed and discussed with regard to teaching of Legal English and Legal German at the Faculty of Law, University of Osijek, Croatia. The main part will be dedicated to the Lifelong Learning Programme for Lawyer Linguists which has been developed at the Faculty of Law in Osijek as a response to current requirements of Croatian membership in the EU and the challenges of internationalization of the labour market.

### 2. Teaching FL for Legal Purposes and intercultural communication in the EU

The White Book of the European Commission points out that every person should be given the opportunity to learn at least two foreign languages in addition to one’s mother tongue (EU Commission, 1995). In accordance with this requirement,

---

<sup>1</sup> Correspondence concerning this article should be addressed to Department of Foreign Languages, Faculty of Law Osijek, Radićeva 13, 31 000 Osijek, Croatia, Contact: [kjubica@pravos.hr](mailto:kjubica@pravos.hr)

higher education institutions are encouraged to ensure resources and provide opportunities for students to continue learning a language appropriate to their programmes of study and fields of work (Council of Europe, 1982). Provisions of the Croatian National Curriculum Framework (NCF, 2010) determine foreign language teaching in Croatian secondary schools in accordance with the Common European Framework of Reference for Languages. As for higher education, the Law on Science and Higher Education as the only relevant legal regulation on higher education mentions foreign languages only within individual study programmes and general goals of the European tertiary education system. By ratifying the Bologna Declaration in May 2001, the Republic of Croatia introduced many changes in its higher education system, especially in terms of curriculum reform and student mobility as well as in teaching and learning of foreign languages. The language policies of higher education institutions should include clearly defined activities to promote foreign language learning and the acquisition of linguistic communicative skills as prerequisites for academic mobility within the European Higher Education Area. Students should master a foreign language to such a level to be able to read scientific and professional papers in a foreign language, to participate in conferences and use a foreign language in direct communication with native speakers. Due to autonomy of higher education institutions, these ideas are implemented at Croatian universities in different ways, with different intensity of FLT and different approaches to the status and importance of foreign languages (Kordić, Lj, Cigan, V. , 2013). Such a situation was confirmed by a study on teaching foreign languages at Croatian universities, which was conducted in 2009 in 143 departments of 5 Croatian universities (Osijek, Zagreb, Zadar, Rijeka and Split). The study showed that in 31% of the departments LSP was not offered to the first year students at all, while 30% of the departments had FL in the second and third years. Only 7% had a FL course incorporated into their curriculum continuously during 6 semesters (Poljaković, Martinović, 2009). The results of this study indicate that in Croatian faculties and other higher education institutions there are many discrepancies concerning the status of foreign languages, the intensity of FL courses, and the ECTS credits allocated to those courses. The data from the annual report of the Josip Juraj Strossmayer University of Osijek for the academic year 2010/2011 (Sveučilišni godišnjak) will be shortly presented here as an illustration of the position of FL at Croatian faculties. The language of law being in the focus of the paper, the data presented here specifically refer to foreign languages for specific purposes.

### 3. FLT in Croatian Tertiary Education

The University of Osijek encompasses nine faculties, one Academy of Arts and five departments: Department of Mathematics, Department of Physics, Department of Biology, Department of Chemistry, and Department of Cultural Studies. Foreign languages taught as LSP at the University are English and German, as well as Italian, which is taught as the third FL at the Academy of Arts.

There are many differences between the faculties in the status, number of credits allocated to the course and even the number of teaching hours of foreign language courses per semester. The Department of Chemistry offers LSP only in the first two semesters, and the Departments of Physics and Mathematics, as well as that of Cultural Studies, have LSP in the first four semesters. The Department of Biology does not have any foreign languages in its curriculum at all. At the Faculty of Agriculture, LSP is taught only to the first year students, but more intensely than at other faculties. That workload is allocated 6 ECTS per semester, which is the highest credit allocated to LSP within the Osijek University. At the Faculty of Food Technology, LSP is learned only by the first year students as a compulsory course in all study groups, with the exception of the "main" study programme Food Technology, in which LSP is taught for four semesters at the BA level. The course is allocated 2 credits in every semester. At the Faculty of Law, FL for Legal Purposes is taught in the first four semesters as a compulsory course, with double the intensity in comparison to other faculties. It is also offered as an elective course in the ninth semester. Nevertheless, the credits allocated represent an average at the University level: 3 ECTS for compulsory courses and 4. 5 for the elective courses *English for EU Law* and *Deutsch für Strafrecht* (Kordić, 2013). The cases presented here indicate a strong influence of the University autonomy, reflected in differences in status, intensity of teaching and the number of credits allocated to foreign language courses. A slight improvement of the situation can be noticed in recent years, but the annual report for the academic year 2010/11 clearly implies that in spite of the declaratory appreciation of multilingualism in the EU, this appreciation remains largely invisible in the teaching practice, since foreign languages are not incorporated in the curricula of two out of nine faculties, while in one faculty no ECTS credits are allocated to FL courses.

#### 4. Developments in LSP Teaching in the Faculty of Law in Osijek

Emergence of different varieties of LSP and the developments in this field in terms of methodology and teaching materials have been the topic of many discussions and scientific papers. The reasons for this boom in the linguistic theory of LSP and its practical application in FL teaching in secondary and higher education all over the world can be seen in the demands of the New World after World War II, a revolution in linguistics and a shift of the focus from the teacher to the learner (Hutchinson and Waters, 1987: 5). By putting the learner in the centre of the teaching discourse, learner's needs became as important in FL teaching as the teaching methodology. For the first time, the teaching content, the design of teaching materials and the choice of teaching methods were based on the learner's reason for learning (Hutchinson and Waters, 1987: 19). This new movement in teaching approach is known as the learner-centred approach. This approach implies various developments in the teaching practice in terms of teaching materials developed in accordance with learner's needs (based on needs analysis), teaching is perceived as guiding, scaffolding and facilitating learning rather than transmitting linguistic knowledge to the learner, real-life tasks get priority in teaching, learners are included in the teaching process with more autonomy and responsibility, they accept more challenging tasks and fulfil them autonomously by using modern technologies.

The changed approach and changes of social, environmental and technological circumstances have reflected in a specific way on the most recent developments in teaching foreign languages for specific purposes at the tertiary level. These developments, well elaborated by Elżbieta Jendrych, include: a) content-and-language-integrated-learning (CLIL), b) use of didactic case-studies, c) corpus studies conducted for teaching purposes and aimed at identifying high frequency language elements: terms, specialized lexis items, collocations, phrases, formulae, acronyms, etc. that need to be prioritized in language courses, d) more effective course-books with higher terminology indexes, e) extended use of online materials, f) teaching writing for specific purposes and g) teaching professional culture and non-linguistic skills (Jendrych, 2013: 46). This list of the current developments in LSP illustrates all the complexity of teaching foreign languages for specific purposes at the higher education level and indicates how many challenges and new requirements modern LSP teachers are confronted with. In the following paragraphs the situation in teaching foreign languages for legal purposes at the University of Osijek shall be presented in the light of these new requirements in teaching LSP at the tertiary level.

##### a) Content-and-language-integrated-learning (CLIL)

The concept of CLIL – Content and Language Integrated Learning - has been strongly advocated by the Language Division of the Council of Europe (2004) on all education levels, especially on the university level. According to main principles of the CLIL-approach, in most European universities foreign languages for specific purposes are instructed by teachers who teach both subject matter and the foreign language. Although English and German as foreign languages for specific purposes are taught in most Croatian universities, the dominant FL is English. This phenomenon is especially observable in recent years, when student mobility between European universities has been intensified. Consequently, not only LSP courses, but also some subject matter courses are held in English. Thus it can be stated that English has become not only the lingua franca of professional and business communication, but also of education and academic communication worldwide. No wonder that this new situation is often informally determined as “Englishization” of tertiary education. These new circumstances demand a new kind of FL teacher, too – either a teacher who has learned a subject matter to such an extent that he/she can competently teach students the content and language integrated topics, or a content matter teacher with good linguistic competence. In my contacts with LSP teachers from other European countries, the latter solution is often encountered in some European countries like Poland, Germany or the Czech Republic. Teaching Legal English by lawyers who additionally have studied English as a foreign language or have studied law (even for several semesters) in the USA or Great Britain is not a rare situation at European law schools. But the prevailing case – like in the Republic of Croatia – is that graduated FL teachers teach subject matter topics in the respective FL. Teaching subject matter in a foreign language is a very demanding task, and FL teachers usually learn the subject matter by individual additional learning from legal textbooks or undertake postgraduate or doctoral studies within the subject matter sciences or those related to them (e. g. FL teachers instructing Business English or Legal English can enrol in European Doctoral Studies at the University of Osijek, which is an interdisciplinary study programme integrating law, political studies and economics).

Teachers teaching FL for Legal Purposes at the Faculty of Law, University of Osijek, are able to fulfil this requirement due to the opportunity to participate several years ago in the TEMPUS project “Foreign Languages in the Field of Law – FLIFL”, coordinated by the Faculty of Law from the University of Zagreb. Target groups of the project were graduated lawyers and FL teachers in the field of law. The main goals of the project were defined as 1) education of FL teachers employed at

---

Croatian law faculties in order to improve their professional credibility in LSP (“Teacher Training Programmes”), 2) education of lawyers in foreign languages (“Lawyer Training Programmes”) and 3) development of FL curricula and modern teaching methodology in conformity with the Bologna requirements and following the needs of Croatian law students (needs analysis was conducted among Croatian lawyers at the beginning of the Project). Teacher training within the Project was organized as a series of workshops including the following topics: *Basics of the EU Law, European Private Law, European Comparative Law, Introduction to the Analysis of EU Law, Introduction to FL for Legal Purposes; Legal Translation and Terminology, Communication Skills for Lawyers, Introduction to Forensic Linguistics, Intercultural Communication for Lawyers, Legal and Linguistic Aspects of Multilingualism, Teaching Legal English – Skills and Materials*, and, finally, *Language Policy of the EU: Sources of Information*. Workshops were organized and delivered by estimated professors teaching at European universities, like Peter Sandrini of the University of Innsbruck, Paul Vertuyten, Diane Phillips, and Ludger Kremer of the University of Antwerp, Werner Schroeder, Andreas Müller, and Eva Lechner (University of Innsbruck), John Olsson of the Forensic Linguistics Institute, Powys Wales UK, Helmut Heiss, Sture P. Ureland, and Olga Voronkova of the University of Mannheim, etc. <sup>1</sup> The knowledge and skills acquired in these workshops made Croatian LSP teachers more competent to teach legal content in their foreign language courses and capable of developing new education programmes which could respond to new professional circumstances and challenges of political, economic and legal changes in Europe.

b) Use of didactic case studies

The second characteristic of recent developments in LSP teaching refers to the introduction of specific cases analysed and solved for didactic purposes. In the field of law, this refers to solving simple legal cases: our second year students are asked to solve a specific case of tort law concerning the missing dog. In this way they are involved in solving a real-life task by following the methods used by lawyers in their professional life. Individual work on relevant legal provisions, prepared at home, is combined with classroom group work in simulations of the court case. By introducing concrete case-study methods in FL courses at law faculties, the requirement for real-life tasks as one of the recent developments in LSP teaching is fulfilled. From a didactical point of view, the case-study method is very fruitful because foreign language is used to solve a real-life task, thereby developing productive writing and speaking skills. The case-study method is student-centred and the language is used in a natural way: as a means, not as an end of teaching discourse activity (Jendrych, 2013: 48).

c) Corpus studies conducted for teaching purposes and aimed at identifying high frequency language elements

This requirement can be fulfilled by those FL teachers who are interested in academic writing and linguistic research. This especially refers to research in legal terminology, collocations and phrases which frequently occur in the language of law and thus represent a linguistic feature which should find its place in teaching specific legal language. At the Faculty of Law in Osijek, this requirement is completely met, because all the three FL teachers explore Legal English and Legal German and apply the results of their research in designing their FL courses. As teaching Legal English and Legal German as compulsory courses is partly restricted by the subject matter content of the respective course books and by the limited number of teaching hours per semester, the results of those linguistic studies have been applied to the greatest extent in the development and design of the Lifelong Learning Programme for Lawyer Linguists, which shall be presented in the main part of this paper.

d) More effective course-books with higher terminology indexes

This requirement is partly fulfilled. Although there are modern textbooks of Legal English and Legal German designed in conformity with recent developments within the CLIL-approach, the LSP teachers of the Osijek Faculty of Law are currently working out the idea of developing a new, more effective course-book, which would be based on the needs analysis. It is important to stress that the foundation for this has been built by an extensive and detailed needs analysis among law students, graduated lawyers and law practitioners in different fields of legal profession, which was conducted in 2003 (Kordić, Mujić, 2004) and again in 2014 (Kordić, Papa, 2014).

e) Extended use of online materials

---

<sup>1</sup> Retrieved from: [www.pravo.unizg.hr/.../Tempus\\_workshops\\_final\\_27\\_March.doc](http://www.pravo.unizg.hr/.../Tempus_workshops_final_27_March.doc), accessed 28/02/ 2015, 19:08



---

Modern computer technologies and achievements of information sciences have been applied in the teaching process at Croatian faculties. This especially refers to students preparing Power Point presentations on legal topics, for which they can use both published legal sources and internet sources. Online sources are also used by students in solving their case study tasks. Still, apart from using sources published on the internet and online dictionaries, there are many other possibilities for law students to use computer technology and online materials, like creating students' own website with the list of legal terminology. This idea has been successfully carried out in some European universities, like in the Foreign Language Centre of the University of Wrocław<sup>1</sup>. Apart from that, there are also online LSP courses that can be used by students on their own. At this point it has to be stressed that students must be warned to use internet information selectively and carefully and to pay attention to credibility of some internet sources they frequently use, e. g. WIKIPEDIA.

f) Teaching professional culture and non-linguistic skills

This requirement is partly fulfilled by means of legal texts dealing with specific topics of the national law (in our case Croatian) and the law of countries where the foreign language is spoken (German law system, British and American legal system). In legal language courses, LSP teachers develop students' cultural and non-linguistic skills as well by sharing their experiences and pointing out the similarities and differences between two professional cultures. Another method we use to achieve this goal is giving individual tasks to students, for example, to watch a TV-series or a movie on specific legal topics and discuss the differences in the classroom.

g) Teaching writing for specific purposes

The achievements within this requirement are rather poor at Croatian law faculties. The emphasis on oral communication skills and the low intensity of teaching hours per week have led to neglecting the importance of writing skills in Croatian law faculties, including the Faculty of Law in Osijek. The only type of written exercise done within FL courses refers to summary writing combined with reading comprehension and determining subtitles to specific legal texts. Our experience and contacts with fellow teachers from other European universities give evidence of far more advanced and intensive use of writing skills, especially in Legal English courses. An interesting example represents creating a website with legal glossary developed by law students, writing legal provisions in plain English, drafting official letters or even contracts in Legal English (Luczak, 2014). It has to be mentioned here that our needs analysis several years ago (2003) showed great interest of our students in speaking skills in LSP, so during the years we have tried to meet this requirement and combine it with internalisation of as much as possible legal terminology and phraseology. Taking into account low intensity of FLT courses per semester and focusing on developing oral communication competence in the respective foreign language, there was little time left to be dedicated to writing skills. Keeping all the factors mentioned here in mind, in my opinion it makes more sense to develop writing skills within groups of students with advanced FL knowledge, like students and graduated lawyers who enrol in lifelong learning programmes in foreign languages and who aspire towards careers on the wider EU labour market. This is the case with the current Lifelong Learning Programme for Lawyer Linguists, which will be described in the following part of this paper.

#### 4. 1 Lifelong Learning Programme for Lawyer Linguists at the Faculty of Law in Osijek

Political and economic changes in modern Europe have reflected on the teaching approach in LSP in a specific way. Financial deregulation, political and economic integrations, greater job mobility and intensified international cooperation, along with the expansion of new communication technologies facilitated and speeded up the international communication and highlighted the importance of foreign languages and communication skills. All these changes have strongly influenced learner's needs in the FL teaching process, especially in the field of FL for legal purposes, which is in the focus of interest in this paper.

Following the guidelines of the Strategy of the Josip Juraj Strossmayer University of Osijek 2011-2020 (Strategy, 2011: 54), the Department of Foreign Languages of the Faculty of Law initiated the introduction of a new lifelong education programme for lawyers. It was a pragmatic response to political and economic changes and requirements of the EU labour market which became accessible to Croatian lawyers as well. The European Personnel Selection Office (EPSO) of the

---

<sup>1</sup> From the workshop „Writing in Plain English“ held by Aleksandra Luczak in „The first Legal English Workshop SHARE & GAIN“, Suprasl, Poland, 18-19 September 2014

European Commission announced job opportunities on the European labour market with the prospect of Croatian full membership in the EU in July 2013. According to the data of December 2012, the European Union needed translators, interpreters, lawyer linguists, administrators, heads of departments and other officials in the field of Communication, Legal Affairs and Programme Management in the offices of the European Commission, the Court of Justice of the EU and other institutions whose employees should master both legal and linguistic knowledge<sup>1</sup>. As a response to new job opportunities for Croatian lawyers, Departments for Foreign Languages of the Faculty of Law in Zagreb and in Osijek initiated their Lifelong Education Programmes for Lawyer Linguists: the former in the summer semester of the year 2011/12 and the latter in the winter semester 2012/13. The Lifelong Learning Programme for Lawyer Linguists in Osijek was organized on similar principles as the Programme of the Zagreb Faculty of Law, but in conformity with specific circumstances at the respective faculty, especially in terms of FL competences and special professional interests of its teaching staff. The Programme developed in Osijek was approved and officially accredited by the Senate of the Osijek University. Altogether 22 ECTS credits were allocated to the Programme, the maximum credit number that can be achieved by individual participant being 18. It encompasses seven courses with altogether 170 teaching hours. The Programme was offered in the winter semester of 2012/2013 to graduate lawyers and 5th year law students and was financed by a participant fee payable in instalments. The Programme was initially introduced to meet demands of the EU institutions for skilled legal translators, but today the target group comprises young lawyers with good foreign language skills who are interested in finding jobs in different EU institutions and/or international companies, due to diverse job opportunities offered to Croatian lawyers on the EU market. The programme is mostly carried out by FL teachers teaching at the Faculty of Law in Osijek, but also by guest professors from the Faculty of Humanities (for the courses *Croatian Language for Lawyer Linguists* and *Introduction to French Legal Translation*). Lectures and exercises within the Programme were held on Fridays and Saturdays during the period of 10 weeks. In the first term (the year 2012/2013), 25 participants were included in this Programme, in the second 18 participants. In this academic year (2014/2015) we have enrolled 10 participants. The reduced number of participants can be seen as a result of the economic crisis and the fact that most of them are unemployed.

The programme carried out in Osijek includes the following courses:

- 1) Introduction to the Theory of Legal Translation and Terminology
- 2) Croatian Language for Lawyer Linguists
- 3) Introduction to the EU Law
- 4) Introduction to French Legal Translation
- 5) EU Vocabulary and Online Language Tools
- 6) Exercises in Legal Translation – English Language
- 7) Exercises in Legal Translation – German Language.

Table 1: Lifelong Learning Programme for Lawyer Linguists at the Faculty of Law in Osijek

Course	Teaching hours	Status of the course	ECTS	Type of assessment
Compulsory courses				
<b>Introduction to the Theory of Legal Translation and Terminology</b>	<b>15</b>	<b>Compulsory</b>	<b>3</b>	<b>Oral exam</b>
<b>Croatian Language for Lawyer Linguists</b>	<b>20</b>	<b>Compulsory</b>	<b>3</b>	<b>Written exam</b>
<b>Introduction to the EU Law</b>	<b>15</b>	<b>Compulsory</b>	<b>3</b>	<b>Oral exam</b>

<sup>1</sup> Retrieved from: [http://www.europa.eu/epso/apply/jobs/temp/index\\_en.htm](http://www.europa.eu/epso/apply/jobs/temp/index_en.htm), accessed 06/09/2012, 20:32

<b>Introduction to French Legal Translation</b>	<b>20</b>	<b>Compulsory</b>	<b>3</b>	<b>Written exam (translation)</b>
<b>EU Vocabulary and Online Language Tools</b>	<b>10</b>	<b>Compulsory</b>	<b>2</b>	<b>Written exam</b>
Legal English-Module	Teaching hours	Status	ECTS	Type of Assessment
<b>Exercises in Legal Translation – English Language FL 1</b>	<b>20</b>	<b>Elective</b>	<b>2</b>	<b>Written exam (translation)</b>
<b>Exercises in Legal Translation – German Language FL 2</b>	<b>20</b>	<b>Elective</b>	<b>2</b>	<b>Written exam (translation)</b>
Legal German Module	Teaching hours	Status	ECTS	Type of Assessment
<b>Exercises in Legal Translation – German Language FL 1</b>	<b>20</b>	<b>Elective</b>	<b>2</b>	<b>Written exam (translation)</b>
<b>Exercises in Legal Translation – English Language FL 2</b>	<b>20</b>	<b>Elective</b>	<b>2</b>	<b>Written exam (translation)</b>

With the exception of the courses in *EU Law* and *EU Vocabulary and Online Language Tools*, the courses are mainly focused on language. In accordance with recent developments in FL teaching, the Programme follows the CLIL approach, as the learner, his interests and learning goals are the central criterion for syllabus design, for choice of teaching materials and most appropriate teaching methods.

All participants have been trained in legal translation in three languages: English, German and French. The knowledge of these three working languages of the EU is required in most jobs announced on the website of the European Personnel Selection Office.<sup>1</sup> As most participants do not speak French, *Introduction to French Legal Translation* is an obligatory course focused on teaching general communication in French including some basic legal terminology.

As for English and German, participants are separated in two groups in these classes: one group includes those who have learned English as their FL 1 and German as their FL 2, and the second group those with German as FL 1 and English as FL 2. Exercises in translation of legal texts in English and in German are focused on the translation process and possible ways of approaching the translation. Teaching materials in both languages are chosen from EU legislation of different types, while several texts pertain to the Croatian national law. Within these courses some changes have been introduced in line with the demands and wishes of our participants: in the beginnings of the Programme, exercises were focused on the analysis and discussion of translations they have done as their homework between sessions, as well as of the translation process, the specific approach to translation of legal texts, specific features of the lexis (polysemy!), syntax, frequent grammar structures and collocations typical of the respective legal language. As learners' needs have been our basic criterion in designing the Programme from the beginning, we have introduced slight changes in the Programme at the request of our participants or based on our own experiences from previous years. This year, therefore, based on experiences of our former attendants who applied for positions in EU institutions or international companies, we have introduced trainings in oral interviews in the last four hours of these courses, because oral interviews conducted by the employer represent an integral part of employment procedure in Europe. Accordingly, from this year on, participants are

<sup>1</sup> Retrieved from [http://europa.eu/epso/apply/jobs/temp/index\\_en.htm#chapter2](http://europa.eu/epso/apply/jobs/temp/index_en.htm#chapter2), accessed 28/02/2015, 23:03

informed in the first session within the Programme about the employment procedure in EU institutions by a FL teacher who experienced all the stages of job application procedure carried out by the EPSO.

Within the course *Croatian Language for Lawyer Linguists* participants are trained in good writing skills, in appropriate use of Croatian orthography and punctuation, with specific reference to dilemmas emerging while writing translation in standard Croatian language. In this course, students participate in the course design by pointing out their own problems arising in writing texts in Croatian language.

*Introduction to the EU Law* has been incorporated in the Programme primarily to meet the needs of those graduate lawyers participating in the Programme who did not have this course in their curriculum while studying law. The participants who had passed the exam in EU Law in their regular study time are exempted from attending this course.

*EU Vocabulary & Online Language Tools* has been introduced as a response to demands of modern business communication as well as to recent developments in translation methodology and translation tools designed by using information technologies. The course is taught by an experienced EFL teacher who was trained in these skills within the TEMPUS project mentioned in the introductory part of this paper. This teacher is probably the most proficient user of information technologies and online translation tools among the teaching staff at the Faculty of Law in Osijek.

#### **4. 2 Designing the Course *Introduction to the Theory of Legal Translation and Terminology*: Achievements and Perspectives**

As mentioned in the introduction to this paper, the entire Programme of education of lawyer-linguists was designed according to learners' needs (learner-centred), based on the CLIL-approach and adjusted to specific circumstances of the Osijek University, especially in terms of appropriate teaching staff equipped and competent to teach specific subjects. Thus, *Introduction to the Theory of Legal Translation and Terminology* was designed and delivered by the author of this paper. The principal factors taken into consideration in the process of the course design were the purpose of the course and the target group of learners, who were equipped with little or no theoretical linguistic knowledge in legal language and in translation process in this field. As one of the main prerequisites for successful teaching outcomes is a competent and motivated teacher, able to motivate his/her students and meet their needs in the respective teaching process, the syllabus was designed based on scientific research the teacher (author of this paper) has conducted in the fields of German, English and Croatian Legal Language since 2004, as well as on written sources on legal translation, specifically Baker's *Encyclopedia of Translation* (Baker, 2009), *New Approach to Legal Translation* by Susan Šarčević (Šarčević, 1997), and Prunc's *Entwicklungslinien der Translationswissenschaft: Von den Asymmetrien der Sprachen zu den Asymmetrien der Macht* (Prunc, 2012).

Apart from the introductory lecture, the course comprises seven basic topics delivered in two hours per week during 10 weeks. Those topics are: 1) General features of legal language; 2) Linguistic features of the German, English and Croatian language of law, 3) Translation as a communication process, 4) Basics of the translation approach in the field of law, 5) EU terminology and phraseology, 6) Poetic elements in legal language – a comparative approach, 7) Summary of the course – most important issues. In the first lecture some universal features typical of the language of law are presented and discussed, such as: a) polysemy and complexity of legal terms, b) difficulties in understanding legal texts due to frequency of Latin loanwords and abstract terms, c) nominal style and frequency of complex and complicated sentences, and d) numerous text types of specific rigid structure and form. In the second lecture linguistic features of German, English and Croatian legal language are discussed on all levels of linguistic analysis apart from phonetics: lexis and semantics, morphology and syntax, word formation and style. Every feature is illustrated by examples in three languages and every session is concluded by a specific task for participants. In the third lecture the translation process is observed from the perspective of communication theory and different translation theories and approaches are discussed with specific reference to legal discourse. The fourth lecture is dedicated to modern approach to the translation process, by highlighting the principle defined by Professor Erich Prunc of the University of Graz as "Enttöschung des Ausgangstextes" and by explaining recent developments of the modern functionalist approach as defined by Vermeer (in: Baker, 2009). The purpose of translation, the target language and the final user of translation as main factors of recent developments in translation theory are discussed and illustrated with specific translation tasks. Special attention is paid to the specific approach required

in legal translation, which has been informally determined as “from-the-macro-level-to-the-micro-level-approach”. In the conclusion of the topic, participants are warned about several problematic issues in legal translation which should be kept in mind in the process of translation, especially concerning conceptual and cultural differences between specific legal systems. In the lecture dedicated to EU terminology students are informed about the importance of the standardization of the EU terminology and consistency in using standardized terms. Additionally, the list of most common EU terms in the field of EU legislation and EU institutions in the three languages is offered to participants, as well as the list of some new EU terms that are not used or are used in a different meaning in standard British English. The lecture dedicated to poetic elements in the language of law discusses this unusual phenomenon from the historic perspective, pointing out that back in 1815 Jakob Grimm had published an article titled “On the Poetry of the Legal Language” (Kordić, 2010). In the main part of the lecture, by using a comparative approach, specific examples of metaphor, alliteration, tautology, personification and doublets are presented in German, English and Croatian language of law, based on the comparative corpus research in German, Croatian and English criminal laws that the author of this paper carried out in 2009 (Kordić, 2010). The final session is planned as a summary of most important facts on legal translation and preparation for the oral exam.

### 5. Concluding remarks

In the introductory part of the paper recent developments in LSP teaching as applied in the Faculty of Law in Osijek have been discussed: a) content-and-language-integrated-learning (CLIL), b) use of didactic case studies, c) corpus studies conducted for teaching purposes and aimed at identifying high frequency language elements, d) more effective course books with higher terminology indexes, e) extended use of online materials, f) teaching writing for specific purposes, and g) teaching professional culture and non-linguistic skills. A short presentation of the Lifelong Education Programme for Lawyer Linguists conducted successfully for three years at the Faculty of Law, University of Osijek, Croatia, can well illustrate that best fulfilment of those requirements can be expected in such LSP programmes developed for specific groups of highly motivated learners attending the courses with clearly defined real-life purposes. It can be concluded that new developments in LSP teaching, resulting from political and economic integrations, greater job mobility and intensified international cooperation by means of new communication technologies, find their most appropriate application in the lifelong learning programmes designed in accordance with real life needs and aspirations of the target group of learners. The learner-centred approach opens the opportunity to students to participate in the course design and to help adjust it to their needs and current requirements of the labour market. However, this implies new requirements, challenges and responsibilities for LSP teachers.

### References:

1. Baker, M. & Saldanha, G. (Eds. ). (2009). Routledge Encyclopedia of Translation Studies, Abingdon: Routledge.
2. Barišić, Zdenka (ed), (2011): Sveučilišni godišnjak Sveučilišta J. J. Strossmayera u Osijeku 2010/2011 [Annual of the J. J. Strossmayer University of Osijek 2010/2011]. Osijek: Sveučilište J. J. Strossmayera.
3. Held, D, McGrew, A, Goldblatt, D, Perraton, J. (1999): Global Transformations. Stanford: Stanford University Press.
4. Hutchinson, T. , Waters, A. (1987): English for Specific Purposes: A learning-centred approach. Cambridge: Cambridge University Press.
5. Jendrych, Elżbieta: Developments in ESP. *Studies in Logic, Grammar and Rhetoric*, 34 (47) / 2013, pp. 43-59.
6. Kordić, Lj, Mujić, N. (2004): Strani jezik u funkciji pravne struke: istraživanje stavova djelatnih pravnika i studenata prava [Foreign Language for Legal Purposes: Exploring Attitudes of Practicing Lawyers and Law Students] . *Pravni vjesnik Pravnog fakulteta Sveučilišta Josipa Jurja Strossmayera u Osijeku*, 3-4/2003, pp. 57-77.
7. Kordić, Lj. (2010): Elementi neformalnosti i poetičnosti u jeziku prava. Zbornik radova HDPL: Prostor i vrijeme u jeziku - jezik u prostoru i vremenu. Međunarodna konferencija HDPL, Osijek, svibanj 2009 (175-1859. [Informal and Poetic Elements in the Language of Law. Proceedings of the International CAAL Conference ‘Space and Time in Language - Language in Space and Time’, Osijek, May 2009 (175-185)]. Zagreb-Osijek: HDPL & Filozofski fakultet Sveučilišta J. J. Strossmayera.

8. Kordić, Lj. , Cigan, V. (2013): Teaching and Learning of Foreign Languages for Legal Purposes in Croatia. *Studies in Logic, Grammar and Rhetoric*, 34 (47) / 2013, pp. 59-75.
9. Kordić, Lj. , Papa, D. (2014): Suradnja među katedrama u svrhu podizanja kvalitete nastave stranih jezika struke – komparativni pristup [Cooperation between Faculty Departments to the Purpose of Quality Improvement in Teaching FL for Specific Purposes – a Comparative Approach]. *Pravni vjesnik Pravnog fakulteta Sveučilišta Josipa Jurja Strossmayera u Osijeku*, 1/ 2014, pp. 73-88.
10. Luczak, A. (2014): Writing in Plain English (workshop). The 1<sup>st</sup> Legal English Workshop SHARE & GAIN, Suprasl, Poland, 18-19 September 2014.
11. Poljaković, I. , Martinović, A. (2009): A New Approach to Teaching Foreign Languages in Universities. In: Granić, J. (ed. ): *Language Policy and Language Reality*, pp. 225-236. Zagreb: HDPL.
12. Prunc, E. (2012): *Entwicklungslinien der Translationswissenschaft: Von den Asymmetrien der Sprachen zu den Asymmetrien der Macht*. Frank & Timme. Šarcević, S. (1997): *New Approach to Legal Translation*. The Hague–London–Boston: Kluwer Law International.

### Documents

Common European Framework of Reference for Languages - CEFR (2005) [ (2005) Zajednički europski referentni okvir za jezike- ZEROJ]. Zagreb: Školska knjiga.

Council of Europe (1982): Recommendation No. R (98)6-Appendix to Recommendation No R (82) 18

Josip Juraj Strossmayer University of Osijek (2011): Strategy of the Josip Juraj Strossmayer University of Osijek 2011-2020. Osijek: Josip Juraj Strossmayer University.

### Internet sources:

Croatian National Education Standard [Hrvatski nacionalni obrazovni standard – HNOS]. Ministarstvo znanosti, obrazovanja i športa (2005) <http://public.mzos.hr/Default.aspx?sec=2199> [Access: 18/10/2010]

European Commission (1995). Weißbuch zur allgemeinen und beruflichen Bildung – Lehren und Lernen – Auf dem Weg zur kognitiven Gesellschaft. <http://europa.eu/documentation/official-docs/white-papers/index.de.htm> [Access:10/04/2013]

National Curriculum Framework [Nacionalni okvirni kurikulum za predškolski odgoj i obrazovanje te opće obvezno i srednjoškolsko obrazovanje – NOK] (2010), <http://public.mzos.hr/Default.aspx?sec=2685> [Access: 18/10/2011]

Science and Higher Education Act [Zakon o znanstvenoj djelatnosti i visokom obrazovanju]. Official Gazette, 123/03 (2003) <http://narodne-novine.nn.hr/clanci/sluzbeni/306330.html> [Access: 18. 10. 2011]

[www.pravo.unizg.hr/.../Tempus\\_workshops\\_final\\_27\\_March.doc](http://www.pravo.unizg.hr/.../Tempus_workshops_final_27_March.doc) [Access: 28/2/2015, 19: 08]

[www.europa.eu/epso/apply/jobs/temp/index.en.htm](http://www.europa.eu/epso/apply/jobs/temp/index.en.htm) [Access 06/09/2012, 20: 32]

[www.europa.eu/epso/apply/jobs/temp/index.en.htm#chapter2](http://www.europa.eu/epso/apply/jobs/temp/index.en.htm#chapter2) [Access: 28/2/2015, 23: 03]

---

## Back to Work with Small Children Comparative Analyses of Maternity/Paternity Leave in the Member States of the European Union

PhD Simona Maria Stanescu,

Research Institute for Quality of Life, Romanian Academy

[simonastanescu2014@gmail.com](mailto:simonastanescu2014@gmail.com)

### Abstract

*The paper contributes to the debate on how to increase fertility. The design of maternity/paternity leave in the 28 member states of the European Union (EU) is researched by secondary analyses on Eurostat and MISSOC databases. Results are presented by three categories of member states: EU founders, other old member states, and Central and East European (CEE) countries. The first part of the article overviews 1960-2012 demographic trends. The second part compares maternity/paternity leave as regulations, applicable statutory basis, basic principles and qualification conditions for benefits in kind and cash benefits, and the duration. 2012 EU-28 confronted the second highest values of deaths recorded for the period 1960-2012 while EU-28 births scored the lowest value since 2006. Updates for maternity/paternity leave date since 2000 in 24 out of EU-28. Five member states follow pre-accession regulations. Legislation focuses specifically on maternity/paternity leave was adopted in 14 member states. Affiliation to compulsory social insurance scheme is the basic principle in providing benefits in kind and cash benefits. Half of member states do not request qualifying conditions for benefits in kind while six don't request any conditions for cash benefits. As duration, the pre-natal maternity leave implies either a precise period of time; either the total leave is to be shared with the post-natal periods. Pre-natal parental leave is regulated in only one country (Estonia); while post-natal is available in 21 member states. Maternity/paternity leave in the case of adoption is regulated in 21 EU member states.*

**Keywords:** EU-28, population change, demographic drivers, fertility rate, maternity/paternity leave, benefits in kind, cash benefits

### Introduction

Harmonisation of *acquis communautaire* in the social field within adherence to EU process by each candidate country, and further engagement towards achieving common targets (Europe 2020) question the post-accession development of national frameworks. On one hand, the European social model is challenged by newly entered member states, and one the other hand, the EU accession shape their social policy design (Vaughan-Whitehead, 2004, 496-501; Vonica, Radutiu 2004: 55-56, Stănescu, 2006, 101-102; Kvist, Saari, 2007, 246-248; Uzlau et al, 2009, 26-29; Cerami et al, 2009, 124-126; Stănescu, 2013, 173-177, Stănescu, 2014, 191-192). From this perspective, the article offer a comparable comprehensive picture of provision of maternity/paternity leave as strategic elements in supporting EU-28 fertility.

The „Incomplete revolution” draws attention to the way public institutions respond to the new role of women in society (Esping-Andersen, 2009). Current family is challenged by demographic trends (Rotaru, 2009, 102-107; Popescu, 2009, 177-181; Ghetau, 2012, 56-58); postponement of marriages and children (Kuronen, 2010, 9; Muresan, 2014, 147-148), precarious work and unemployment especially for women from vulnerable groups (Preoteasa, 2013, 165-166; Balan et al, 2014, 17-18; Vlase, 2014, 253-255), family conflicts (Turliuc et al, 2013, 42-46), the quality of community life (Mihalache, 2011, 138-139), migration (Balan et al, 2013, 78); provision of cash benefits and social services and the orientation of family support policies (Stănescu, 2014, 779-782). The degree of appropriateness answer to needs in taking care of the children have a direct consequence on children as they risk to be neglected or abused, to drop out school or to become delinquent (Neamtu, 2007, 212-233; Cojocaru, 2009, 70; Panzaru et al, 2013, 33; Luca, 2014, 37-41; Tomita, 2014, 83-84).

### Methodology

The first part of the article analysis the demographic trends in the EU-28 member states for the period 1960-2012: number of births and death, population change, demographic drivers, and fertility rate (live births per women). The second part focuses on national regulations adopted in the EU-28 with respect to maternity/paternity leave as chronological

development of national regulations, basic principles, types of benefits (in kind, cash); and duration of leave. The third part of the paper is focus on conclusions and further research directions.

In terms of methodology, secondary analysis and content analysis were used for Eurostat, the statistical office of the EU and the Mutual Information System on Social Protection (MISSOC) database of the European Commission, Directorate-General for Employment, Social Affairs, and Equal Opportunities. Desk research allows that national information was double checked and improved updates were added.

Compared EU-28 research outputs were presented in relation to their accession to the EU by the following typology: the EU founder states<sup>1</sup>, other old member states than EU founders<sup>2</sup>, and Central and East European (CEE) member states<sup>3</sup> (Stănescu, Nemtanu, 2015). The paper continues previous research done on EU member states and on family benefits as part of a post-doctoral programme as acknowledged.

### Demographic trends

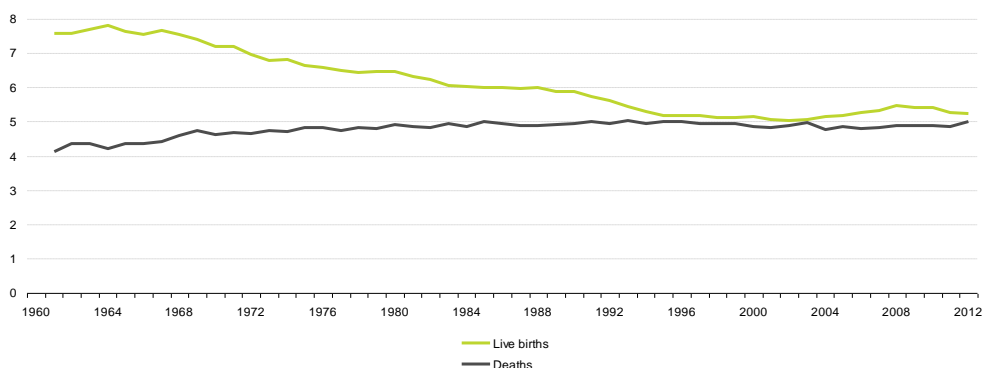
According to Eurostat data for the period 1961-2012, the number of EU-28 births continues to decrease while the number of EU-28 deaths is slowly increasing.

The highest value of births was registered in 1964 with 7.81 millions while the lowest one was recorded in 2002 with 5.03 millions. In 2012, the number of births was 5.23 millions representing the lowest since 2006, and one of the lowest for the period 1961-2012.

The number of deaths scored the highest value in 1993 with 5.03 millions, and the lowest one in 1961 with 4.14 millions. Both in 2012, and in 1985, the second highest EU-28 value of deaths was registered: 5.01 millions.

The EU-28 natural change as the difference between live births, and number of deaths registered top three highest values during the 1960s: 3.6 millions in 1964, 3.5 millions in 1961, and 3.3 millions in both 1963, and in 1965. Lowest values of natural change were recorded starting with the mid 1990s: 0.1 million in both 2002 and 2003; and 0.2 millions for the period 1995-1999, for 2001, and for 2012.

Figure 1: Births and deaths, EU-28, 1961–2012 (million)



Source: Eurostat

<sup>1</sup> France, Germany, Italy, The Netherlands, Belgium, and Luxembourg

<sup>2</sup> Denmark, Ireland, United Kingdom, Greece, Portugal, Spain, Austria, Finland, and Sweden

<sup>3</sup> Cyprus, Czech Republic, Estonia, Hungary, Latvia, Lithuania, Malta, Poland, Slovakia, Slovenia; Bulgaria, Romania, and Croatia

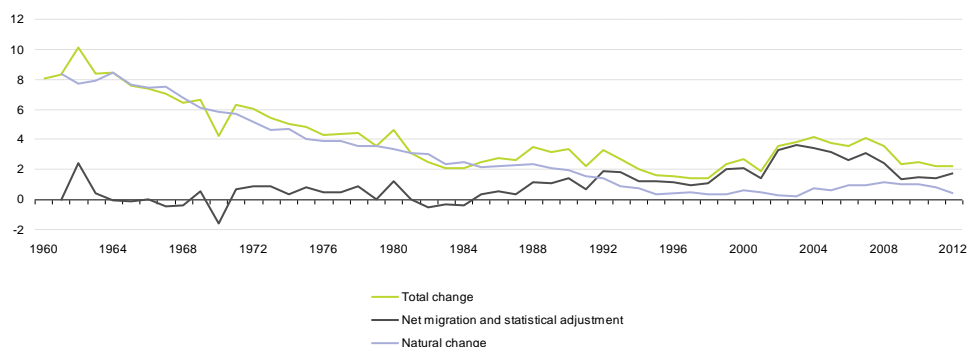


Note: 1960 not available. Excluding French overseas departments up to and including 1997

The EU-28 total population change for the period 1960-2012 registered the highest three values during the 1960s: in 1962 with 10.16 per 1000 inhabitants; in 1964 with 8.43; and in 1963 with 8.35. Lowest values of total population change were recorded during the second half of the 1990s: in 1997 with 1.39; in 1998 with 1.44, and in 1996 with 1.53.

Net migration and statistical adjustment as the total change minus natural change registered the highest EU-28 values during the 2000s: 3.66 in 2003, 3.41 in 2004, and 2.63 in 2006. To the contrary, the lowest values were registered in 1970 (-1.60), in 1982 (-0.52), and in 1967 (-0.49).

Figure 2: Population change by component (annual crude rates), EU-28, 1960–2012 (per 1000 inhabitants)



Source: Eurostat

Note: 1960 not available for net migration, and statistical adjustment, and for natural change. Excluding French overseas departments up to and including 1997. Breaks in series: 2001, 2007 and 2011–12.

In respect to EU-28 population change between 1<sup>st</sup> of January 2012 and 2013 by the three analysed categories of EU member states, demographic drivers led to growth. It was the case of all six EU founder states; five out of nine other old member states than the EU founders, and five out of 13 CEE member states. Growth due only to natural change was not registered in any EU founder states, but this was the case of Ireland and Cyprus. None of the CEE countries registered positive population change because the population growth was faced with the negative net migration (and adjustment).

No population decline was registered in the six EU founder states. In the case of other old member states, the population decline was not due to natural change but, similar to the new member-state, some of these states (Greece, Portugal, and Spain) recorded decline because of net migration (and adjustments), and to negative migrations (and adjustments).

Table 1: Contribution of natural change and net migration (and statistical adjustment) to population change, 2012

	Population growth			Population decline		
	EU founder states	Other old member states	CEE member states	EU founder states	Other old member states	CEE member states
Only to natural change	-	IE	CY	-	-	HU, RO
More to natural change	FR, NL	UK	SI	-	-	BG, HR
More to net migration (and adjustment)	BE, LU	DK, FI, SW	CZ, MT, SK	-	EE, PT	ET, LV, LT
Only to negative net migration (and adjustment)	DE, IT	AT	-	-	ES	PL

Source: Eurostat

For the period 1960-2012, the highest values of fertility rates as live births per women developed different trends among the three categories of EU member states.

Top position for EU founder states was shared by two countries: The Netherlands and France.

The category of other old member states than EU founders was the most stable one with the same country occupying top position except for one year. Ireland had highest values of fertility rates except for 1990 when Sweden registered 2,13 (comparable with 2,11 in Ireland). It is to be mention that abortion is allowed in Ireland only to safe the life of the women. At EU-28 level, abortion restrictions in Ireland are surpassed only by Malta where even above mention ground is strictly forbidden.

The situation of fertility rates in the CEE member states is differentiated as six out of the 13 countries ranked on top positions. The highest values were registered three times in Estonia (2005, 2010, and 2011); twice in Slovakia (1960 and 1970); and once in Romania (1980); in Cyprus (1990); in Malta (2000); and in Lithuania (2012). It was noticed a slight difference in the case of Croatia which registered 1,50 in 2005 as compared with top 1,52 for Estonia.

In terms of highest value per categories of countries, the EU founders members registered fertility rate of 3,12 in 1960 in the Netherlands, while other old member state had rates of as had 3,85 in 1970 in Ireland, and CEE registered fertility rates of registered 3,04 in 1960 in Slovakia. Looking at the highest value of fertility rates indicator, we notice that the lowest values registered per category of countries were: 1,78 (in 1990 in France as representative for the EU founder states category); 1,86 in 2005 in Ireland (for the category of other old member states); and 1,52 also in 2005 in Estonia (for the CEE member states).

Table 2: Highest values of fertility rates per categories of member states of the European Union

	EU founder states	Other old member states	Central and Eastern member states
1960	3,12 Netherlands	2,78 Ireland	3,04 Slovakia
1970	2,57 Netherlands	3,85 Ireland	2,41 Slovakia
1980	1,95 France	3,21 Ireland	2,43 Romania
1990	1,78 France	2,13 Sweden	2,41 Cyprus
2000	1,89 France	1,89 Ireland	1,70 Malta

	EU founder states	Other old member states	Central and Eastern member states
2005	1,94 France	1,86 Ireland	1,52 Estonia
2010	2,03 France	2,05 Ireland	1,72 Estonia
2011	2,01 France	2, 03 Ireland	1,61 Estonia
2012	2,01 France	2,01 Ireland	1,60 Lithuania

Source: Eurostat

We analyse below the lowest values registered for the fertility rate looking at top ranked countries and their recorded values. Looking at the EU founder states, Luxembourg occupied this position three consecutive times (1960, 1970, and 1980), and than Italy follows for three times in this ranking (1990, 2000, and 2005). Starting with 2004, Germany is constantly the EU founder state with the lowest fertility rate.

Lowest fertility rates in other old member states than the EU founder states was recorded in two north countries (in 1970 in Finland and in 1980 in Denmark), followed by two south countries Greece (1960, 2005, and 2012); and Spain (1990, 2000, 2010, and 2011). The slight value difference can be noticed which was registered in Spain in respectively 1. 33, as compared with 1,32 in Greece.

Five out of the 13 CEE member states, registered lowest values of fertility rates: three times in Hungary (1980, 2000, and 2011); twice in the Czech Republic (1970 and 2000); twice in Poland (2005 and 2012); and once in Estonia (1960); and in Slovenia (1990). Estonia is the only country which was present in both top rankings: as the country with the lowest fertility rate in 1960 and the highest one in 2005, 2010, and 2011. An in-depth national analysis of the reasons behind this change is not the topic of the present paper but these findings could be further developed and could support the identifying process of best practices in the pro-fertility field that would have the potential to be adjusted for other EU national contexts.

Table 3: Lowest values of fertility rates per categories of member states of the European Union

	EU founder states	Other old member states	Central and Eastern member states
1960	2,29 Luxembourg	2,23 Greece	1,98 Estonia
1970	1,97 Luxembourg	1,83 Finland	1,92 Czech Republic
1980	1,50 Luxembourg	1,55 Denmark	1,91 Hungary
1990	1,33 Italy	1,36 Spain	1,46 Slovenia
2000	1,26 Italy	1,23 Spain	1,15 Czech Republic
2005	1,34 Italy	1,32 Greece	1,24 Poland
	1,34 Germany		
2010	1,39 Germany	1,37 Spain	1,25 Hungary
2011	1,36 Germany	1,34 Spain	1,26 Hungary
2012	1,38 Germany	1,32 Spain	1,30 Poland
		1,34 Greece	

Source: Eurostat

Different statistic data are provided by Eurostat for Slovakia and for the Czech Republic before 1989. Still, while Slovakia held the top position in 1970, the Czech Republic registered the lowest values among CEE countries. The differences due to different regulations in supporting families are not approached in this paper but they could bring further insights in this matter.

### Chronological development of regulations of maternity/paternity leave

Recent updates in maternity/paternity leave in 24 analysed countries date since 2000. The four exceptions are: Austria with regulations from 1967; United Kingdom back in 1992; and Belgium and Hungary since 1997. The newest EU-28 legislative modifications were adopted by Bulgaria in 2014.

Among EU founder states, Belgium preserves its regulations since 1997 while latest changes were registered in 2012 in Germany and in Italy. In the case of France the modifications in maternity/paternity leave are impacted also by the Social Security Code which is regularly updated.

Table 4: Recent regulations of maternity/paternity leave within founder members of the European Union

No.	Country	EU	Latest regulations
1.	France	1951	2015
2.	Germany	1951	2012
3.	Italy	1951	2012
4.	The Netherlands	1951	2005
5.	Belgium	1951	1997
6.	Luxembourg	1951	2008

Source: MISSOC data base

Within other old member states than EU founders, Austria is the only case where latest regulations date before its accession to the EU. The newest ones are in Denmark, since 2013, 30 years after becoming a member state. In comparison with the moment of joining the EU, latest regulations date 32 years after EU accession in Ireland; 23 years after in both Spain and Portugal; 19 years after in United Kingdom and Greece; 15 years after in Sweden; and nine years in Finland.

Table 5: Recent regulations of maternity/paternity leave within other old member states except founder states of the European Union

No.	Country	Latest regulations	EU accession	Latest regulations
1.	Denmark		1973	2013
2.	Ireland		1973	2005
3.	United Kingdom		1973	1992
4.	Greece		1981	2000
5.	Portugal		1986	2009
6.	Spain		1986	2009

No.	Country	Latest regulations	EU accession	Latest regulations
7.	Austria	1967	1995	
8.	Finland		1995	2004
9.	Sweden		1995	2010

Source: MISSOC data base

Four CEE countries provide maternity/paternity leave following updated regulations adopted before their EU accession. It is the case of: Hungary and Croatia (seven years before); Lithuania (four years before), and Estonia (two years before).

Eight CEE countries changed their regulations after joining EU: Poland and Slovakia in 2004; Czech Republic and Romania (three years after); Bulgaria (seven years after); and Cyprus, Latvia, and Slovenia (nine years after). Maternity/paternity leave in Malta is governed by the Social Security Act.

Table 6: Recent regulations of maternity/paternity leave within Central and Eastern European member states

No.	Country	Latest regulations	EU accession	Latest regulations
1.	Cyprus		2004	2013
2.	Czech Republic		2004	2008
3.	Estonia	2002	2004	
4.	Hungary	1997	2004	
5.	Latvia		2004	2013
6.	Lithuania	2000	2004	
7.-	Malta	-	2004	-
8.	Poland		2004	2004
9.	Slovakia		2004	2004
10.	Slovenia		2004	2013
11.	Bulgaria		2007	2014
12.	Romania		2007	2010
13.	Croatia	2008	2013	

Source: MISSOC data base

### Applicable statutory basis for maternity/paternity leave

Depending on the national legislative frameworks, maternity/paternity leave is governed by various normative types such as: acts, codes, laws, emergency ordinances, and decrees. No common trend was identified in EU-28 analysed countries.

Still, dedicated normative acts on the subject of maternity/paternity are in force in 14 member states. The detailed picture is as follows: three EU founder states (Belgium, Italy, and The Netherlands); four other old member states (Denmark, Finland,

Portugal, and Sweden); and seven CEE member states (Croatia, Latvia, Lithuania, Poland, Romania, Slovakia, and Slovenia). Laws on protecting working mothers were adopted in Germany and in Italy.

Maternity/paternity leave is also regulated under complementary legislative acts under various subjects such as:

- health care (Belgium, Czech Republic, Denmark, Estonia, Finland, Hungary, Ireland, Italy, Latvia, Lithuania, Poland, Slovakia, Slovenia, and The Netherlands);
- social insurance (Austria, Bulgaria, Cyprus, Czech Republic, Greece, Latvia, Lithuania, Poland, Slovakia, and Sweden);
- labour (Belgium, Bulgaria, Denmark, France, Malta, Portugal, Slovakia, Slovenia, Spain, and The Netherlands);
- social security (France, Germany, Luxembourg, Malta, Spain, and United Kingdom);
- equal treatment between men and women (Italy and Spain);
- family (Austria);
- social welfare (Hungary);
- child (Romania).

### **Basic principles of providing maternity/paternity leave**

The main principle in providing benefits in kind and cash benefits related to maternity leave is the affiliation to compulsory social insurance scheme. In Denmark it is in-force the universal public health service for benefits in kind, and universal protection scheme for cash benefits. A similar situation is in Finland. Voluntary insurances are available for self-employed persons in Bulgaria, in Czech Republic, and in Slovakia. In The Netherlands not insured self-employed can apply for cash benefits. In Finland, Portugal, Spain, and United Kingdom special cash benefits are available for parents who do not satisfy the minimum conditions for ordinary maternity/paternity support.

Residency criteria is specifically mentioned in Bulgaria, France, Ireland, Italy, Latvia, Malta, Poland, Portugal, Slovakia, Sweden, The Netherlands, and United Kingdom. A further research on eligibility criteria for being socially insured in other EU member states than above mentioned ones would probably support the idea of residency for more countries than the ones explicitly referring to it. In The Netherlands working non-residents are entitled for benefits in kind. Unauthorised foreigners in Spain are entitled to receive health care during pregnancy, birth and postpartum.

Other expressions used when referring to potential beneficiaries of maternity//paternity leave are:

- all inhabitants (Denmark, Finland, Ireland, Italy, Latvia, Portugal, and Romania);
- members of the family (Belgium and Spain);
- active population and assimilated groups (Poland and Spain);
- national (Bulgaria);
- certain categories of citizens (Cyprus);
- female dependants (Greece);
- various other groups (Hungary);
- employees and assimilated (Italy);
- spouses of residents (Malta).

Profession related insurance approach for maternity/paternity leave is applicable in one EU founder (France), and two CEE member states (Lithuania and Slovakia). In the case of benefits in kind in France the difference is made between compulsory social insurance scheme with affiliation based firstly on professional criteria and secondly based on residency. Similarly, special schemes applies for certain professional categories in Lithuania (officers of the police, state security, defence and related services financed by the state), and in Slovakia (for policemen, soldiers, and customs officers).

### **Benefits in kind related to maternity/paternity leave**

Half of the EU member states do not request any qualifying condition. It is the case of three EU founder states (Germany, Luxembourg, and The Netherlands); three other old member states (Austria, Finland, and Spain); and eight CEE countries (Croatia, Czech Republic, Estonia, Hungary, Latvia, Poland, Romania, and Slovenia).

Frequent eligibility criteria for benefits in kind are: residence (Cyprus, Denmark, Ireland, Portugal, Slovakia Sweden, and United Kingdom); previous contribution to insurance scheme (Belgium, France, Greece, and Malta); working status (Sweden). In Cyprus citizenship as eligibility criteria is not applicable for beneficiaries of public assistance. In Italy the beneficiary should be registered at the National Health Service.

Various forms of benefits in kind are offered in analysed EU-28 member states. They include free medical services/midwife care during the pregnancy, birth, and postpartum; pharmaceutical products; or forms of exemption or reimbursements of payments of various patients' fees and contributions. Monitoring and assistance during labour, and delivery at home are provided in Belgium. In slightly different conditions due to recent changes they are also available in Hungary. Home care is offered in Germany. In Slovenia includes two visits of the nurse. In Greece childbirth benefit is provided for women giving birth out of hospital facilities (for example at home). Different amounts are supported for hospitalisation in private clinics in Greece depending on their contracts with the National Health System. A maternity package with necessities for child care (or its 140 euro equivalent) is offered in Finland.

### **Cash benefits related to maternity/paternity leave**

Six EU member states do not request any qualifying conditions: two EU founder (Italy and The Netherlands); one other old member state (Austria); and three CEE countries (Latvia, Poland, and Malta).

The most frequent condition for receiving cash benefits is the previous contributions to insurance scheme (Belgium, Bulgaria, Croatia, Cyprus, Denmark, France, Greece, Hungary, Ireland, Lithuania, Portugal, Romania, Slovenia, and Sweden). The insured period vary between 26 weeks (Cyprus); to six months (Belgium, Luxembourg, and Portugal), 240 days (Sweden); 270 days in the last two years (Czech Republic and Slovakia); and 12 months (Bulgaria, Croatia, and Lithuania).

Insurances contributions with interruptions are accepted in Croatia (18 months during last two years); in Denmark (120 hours worked in previous 13 weeks); in Greece (200 days during last two years); in Ireland (39 contributions paid or credited one year before for employees and 52 contributions within last, second last or third last year for self-employed); in Lithuania (12 months insurance during past 24 months); in Romania (1 month in the last 12 months); and in Spain (180 contributions in the previous seven years before birth or 360 contributions days in the whole working life).

Other eligibility conditions include: working status (Estonia); and determined period of previous residency (Finland). No minimum working contribution is required in Spain in the case of workers under 21 years.

Other eligible categories of beneficiaries include unemployed entitled to unemployment insurance, persons finalising a vocational course within previous 18 months, beneficiaries of activation measures on the labour market, students in paid internship, or people in a flexible job. A ten days benefit is paid in Sweden for parents who refrain from work in connection wit the death of their child under 18 years child.

### **Duration of maternity/paternity leave**

Analyse includes two dimensions: before and after birth periods, and support measures allocated by gender.

By categories of EU member states, the EU founder states is the most stable category providing similar pre-natal and post-natal coverage of maternity/paternity leave. The following category is represented by CEE member states.

All EU founder states provide pre natal and post-natal maternity leave. None of them provides pre-natal paternity leave. Post-natal paternity leave is provided in all six countries except Germany.

As for the category other old member states than EU founders, pre-natal maternity leave is regulated except Spain. Pre-natal paternity leave is not provided while the post-natal one is provided in five countries: Denmark, Spain, Portugal, Finland, and United Kingdom.

Pre-natal and post-natal maternity leave are regulated in all CEE member states. Estonia is the only EU country providing pre-natal paternity leave which optionally could be taken after the birth. Post-natal paternity leave is provided in nine CEE states.

Table 7: Provision of maternity/paternity leave in EU-28 member states

	EU founder states	Other old member states	CEE member states
Pre-natal maternity leave	BE, DE, FR, IT, LU, NL	DK, IE, EL, AT, PT, FI, SW, UK	BG, CZ, ET, HR, CY, LV, LT, HU, MT, PL, RO, SI, SK
Pre-natal paternity leave	-	-	ET
Post-natal maternity leave	BE, DE, FR, IT, LU, NL	DK, IE, EL, ES, AT, PT, FI, SW, UK	BG, CZ, ET, HR, CY, LV, LT, HU, MT, PL, RO, SI, SK
Post-natal paternity leave	BE, FR, IT, LU, NL	DK, ES, PT, FI, UK	BG, ET, LV, LT, HU, MT, PL, RO, SI

Source: Author's calculations based on MISSOC data base

Two cases of before birth maternity leave were identified: either a precise period of time is mentioned, either a total amount of time to be split between pre-natal and post-natal periods. Countries from the first category are: Belgium, Croatia, Denmark, France, Germany, Lithuania, Luxembourg, Romania, Slovakia, Spain, and Sweden. The second category includes: Austria, Bulgaria, Cyprus, Czech Republic, Estonia, Finland, Greece, Hungary, Ireland, Italy, Latvia, Malta, Poland, Portugal, Slovenia, The Netherlands, and United Kingdom. Some countries from the first category offer the possibility to add the remaining pre-natal maternity leave to the post-natal one. It is the case of Belgium, France, Germany, and Romania. A further research on this particular aspect would support a better understanding of pre-natal common trends in EU-28.

Table 8: Provision of pre-natal maternity leave by regulated amount of time

	EU founder states	Other old member states	Central and Eastern member states
Fixed	BE, FR, DE, LU	DK, ES, SW	HR, LT, RO, SK
Flexible	IT, NL	AT, PT, FI, ES, IE, UK	BG, CY, CZ, ET, HU, LV, MT, PL, SI

Source: Author's calculations based on MISSOC data base



---

Maternity leave in analysed EU-28 member states include different periods of time as follows:

- eight weeks (Austria);
- 14 weeks (Belgium, Germany, Malta, and Sweden);
- 15 weeks (Finland and Slovenia);
- 16 weeks (France, Latvia, Luxembourg, Spain, and The Netherlands);
- 17 weeks (Greece);
- 18 weeks (Cyprus, Denmark, Lithuania, and Romania);
- 20 weeks (Estonia and Poland);
- 24 weeks (Hungary);
- 26 weeks (Ireland);
- 28 weeks (Czech Republic);
- 34 weeks (Slovakia);
- 52 weeks (United Kingdom);
- 120 or 150 days (Portugal);
- five months (Italy);
- seven months (Croatia);
- 420 days (Bulgaria).

The compulsory maternity leave period is mentioned rather after the birth than before the birth. Still, compulsory pre-natal leave varies between minimum one week in Belgium and a maximum of four weeks in The Netherlands. Regardless the two above mentioned category of time regulation, other recommended period of pre-natal leave are:

- two weeks (Ireland);
- four weeks (Denmark, Estonia, Hungary, Italy, Portugal, Slovenia, and The Netherlands);
- five weeks (Malta);
- six weeks (Belgium, Bulgaria France, and Germany);
- seven weeks (Sweden);
- 56 days (Greece and Latvia)
- 30-50 days (Finland);
- 63 days (Romania)
- Between the 9<sup>th</sup> and 2<sup>nd</sup> weeks (Cyprus);
- Six to eight weeks (Czech Republic, Poland, and Slovakia);
- 11 weeks (United Kingdom);
- 70 days (Lithuania).

Special cases (multiple births, complication, premature, hospitalisation, and Caesarean) implies additional period of leave in Austria, Belgium, Croatia, Czech Republic, France, Germany, Poland, Latvia, Lithuania, and in Spain. Benefits for risk during pregnancy are provided in Portugal and in Spain.

When regulated, the compulsory post-natal maternity leave could include: four weeks (Ireland); six weeks (Czech Republic, Romania); or nine weeks (Belgium). For more details please consult Annex 1: Duration of maternity/paternity leave in EU-28 member states.

The only country mentioning conditions for paternity leave is Estonia where ten days can be taken either before or after the delivery. The minimum numbers of days for post-natal paternity leave is one compulsory day in Italy while the maximum is 54 days in Finland. Other allocated amounts of time are:

- two days (Luxembourg, Malta, and the Netherlands);
- five days (in Hungary and Romania);
- One or two weeks (United Kingdom);
- ten days (Belgium, Estonia, Latvia, and Portugal);
- 11 days (France);
- 14 days (Denmark and Poland);
- 15 days (Bulgaria and Slovenia);
- 18 days (in France in the case of multiple births);
- four weeks (Lithuania and Spain);
- 54 days (Finland).

Additional days for paternity leave are available: two days in Italy; ten days in both Romania (if the father graduates an infant care course) and Portugal; and 75 days in Slovenia.

No post-natal paternity leave is regulated in Austria, Croatia, Cyprus, Czech Republic, Germany, Greece, Ireland, Slovakia, and Sweden. Still, in some of these countries fathers are supported by other means. In Croatia, the father can continue the maternity leave but only after 70 days after birth. In Ireland some employers provide paid leave even if it is not compulsory in the country. Reduced working hours are available in Greece for parents after an additional special maternity leave (which follows the ordinary maternity leave and can be up to six months).

Some countries support the involvement of both mothers and fathers in the child care during first months. Two sets of measures were identified: either by the possibility to transfer the remained time from not used maternity leave to the father; either by common parental leave (32 weeks in Denmark before the 9<sup>th</sup> birthday of the child, 158 days in Finland, and three months in Portugal). The Slovenian father can take 75 days unpaid leave till the third anniversary of the child. The Romanian father should take one month out of the 12 child raising leave which follows the maternity leave.

Difference between employed and self-employed people when touching maternity benefits is made in both Belgium and France. Special maternity allowance is offered for Finish mothers if the working environment exposed them to chemical substances, radiation, or to an infectious disease. Austrian post-natal maternity leave is provided for the duration of an individual employment prohibition. Reduced working hours for parents are regulated in Denmark, in Greece, and in Sweden. A benefit for risk is paid for Spanish breastfeeding working mothers till child reaches nine months of age.

The Finish maternity/paternity leave includes consecutive calendar days except Sundays. Calendar days are also mentioned in Latvia and in Lithuania.

---

Portuguese grandparents are entitled to substitute parents in leave if special conditions are accomplished (i. g. living in the same household or parents less than 16 years).

Adoption maternity/paternity leave is regulated in 21 EU member states as follows: five EU founders (Belgium, France, Italy, Luxembourg, and the Netherlands); eight other old member states (Denmark, Finland, Greece, Ireland, Poland, Portugal, Spain, and United Kingdom); and eight CEE countries (Bulgaria, Croatia, Cyprus, Czech Republic, Estonia, Hungary, Slovakia, and Slovenia).

Regarding continued payment of maternity/paternity leave by the employer, no statutory continuation is regulated in 21 EU member states: half of EU founder states (Belgium, Luxembourg, and The Netherlands); seven other old member states (Austria, Denmark, Finland, Ireland, Portugal, Spain, and Sweden), and 12 CEE countries (except Malta). Employer is involved in the payment for differences in the case of poor employees (Austria); or for the differences between maternity benefits and salary (France and Germany). Payments are also supported by the employer in line with additional conditions included in collective agreements (Cyprus and Spain). Certain periods of time are supported by employers from Belgium (first three days of the paternity/adoption leave); from Greece (15 days/one months depending of number of completed worked days); and from Malta (14 weeks of maternity leave, and two days of paternity leave).

## Conclusions

First part of the paper overviews demographic trends in EU-28. Eurostat 1960-2012 data showed a decreased number of births and an increased number of deaths. As shown in figure 1, EU-28 births in 2012 scored the lowest value since 2006 while the number of death was the second higher one since 1960.

Demographic drivers conducted to population growth in 17 member states: all EU founder states, six other old member states than EU founders, and five CEE countries. No growth only to natural change was registered in EU founder states. No population decline due only to or more to natural change was recorded in the category of other old member states than EU founders.

1960-2012 fertility rates showed different patterns within the three categories of member states. Top position as highest fertility rates within other old member states was occupied by Ireland (except for 1990); while The Netherlands and France shared top positions among EU founders. Six CEE countries occupied this position among which Estonia three for three consecutive periods of time. The highest value for 1960-2012 was 3,85 registered in 1970 in Ireland, country where abortion is only allowed to save the life of the women.

The second part of the article compares provision of maternity/paternity leave in EU-28 by the three categories of EU member states. Analysed aspects were the following: national regulations, applicable statutory basis, basic principles and qualification conditions in providing benefits in kind and cash benefits, as well as the duration of maternity/paternity leave.

Updated regulations for maternity/paternity leave date since 2000 in 24 out of EU-28. Among other old member states than EU founders, Austria is the only country which still follows pre-accession adopted regulation. The same applies for four CEE member states: Estonia, Hungary, Lithuania, and Croatia.

From the applicable statutory basis, special legislative acts on maternity/paternity leave were adopted in 14 member states: three EU founder states, four other old member states, and seven CEE countries. Complementary regulations with impact on maternity/paternity leave refers to various issues such as health care, social insurance, labour, social security, equal treatment between men and women, family, social welfare, and child.

Main basic principle in providing benefits in kind and cash benefits related to maternity/paternity leave is the affiliation to compulsory social insurance scheme. Some countries accept contributory periods with interruptions.

Half of EU-28 member states do not request qualifying conditions for providing benefits in kind. Still, eligibility criteria include residence, previous contribution to insurance scheme, or working status. Six EU member states don't request qualifying conditions for cash benefits. Still, the most frequent condition is previous contribution to insurance scheme.

Duration of maternity/paternity leave was analysed as pre-natal and post-natal regulated for both mothers and fathers. Per category of EU member states, CEE counties covered all four types of leave (pre-natal and post-natal leave for both men and women).

Two cases of before birth maternity leave were identified: either a precise period of time is mentioned, either a total amount of time to be split between pre-natal and post-natal periods. Detailed analyse for each category are included in the article.

21 EU member states regulate adoption maternity/paternity leave as follows: five EU founders (except Germany); eight other old member states (except Austria); and eight CEE countries (except Latvia, Lithuania, Malta, Poland, and Romania).

Continued payment of maternity/paternity leave is not regulated in 21 member states. In other states, the employer is involved in the payment related to income differences or to regulated periods of time.

Research on maternity/paternity leave will be continued with analyse of complementary family benefits. Few questions arise. To what extend are the current maternity/paternity leave related regulations suitable in the child delivery and care process? Which elements are to be further adjusted? Are the parents really supported in the process of having and raising a child? Can parents go back to work having small children at home?

Despite common interest for family within current demographic trends, the design of family support policies is to be further tackled and, in this respect, one of first steps is a better harmonisation of maternity/paternity leave among EU-28.

Home-work struggle for balance and population change call for a friendly approach of designed social policy measures. One cannot dream about sustainable demographic scenario without paying proper attention to efficiency of child delivery and care process.

## Acknowledgement

This paper has been written and published under the aegis of the Research Institute for Quality of Life, Romanian Academy as part of the postdoctoral research programme co-funded by the European Union within the Sectorial Operational Programme for Human Resources Development through the project "Pluridisciplinarity and interdisciplinarity in doctoral and post-doctoral programmes" Project Code: POSDRU/159/1. 5/S/141086.

## References

Balan, M. ; Vasile, V. ; Stanescu, S. M. ; 2013. Gravity model application to estimate Romanian migration size, *Knowledge horizons*, volume 5, no. 2/2013, 74-78

[http://www.orizonturi.ucdc.ro/arhiva/2013\\_khe\\_2\\_pdf/khe\\_vol\\_5\\_iss\\_2\\_74to78.pdf](http://www.orizonturi.ucdc.ro/arhiva/2013_khe_2_pdf/khe_vol_5_iss_2_74to78.pdf)

Balan, M. ; Stanescu, S. M. ; 2014. Unemployment Impact on Families in Development Regions of Romania, in Constantineanu, C. ; Runcan, P. ; Runcan, R. (editors) *Authority & Power of Christian Values*, Bucuresti, Editura Didactica si Pedagogica, 11-18

Cerami, A. ; Stanescu, S. M. ; 2009. Welfare State Transformation in Bulgaria and Romania, in Cerami, A. ; Vanhuyse, P. (editors) *Post-Communist Welfare Pathways Theorizing Social Policy Transformations in Central and Eastern Europe*, Palgrave, Macmillan, 112-126

Cojocar, S. 2009. Child rights based analysis of children without parental care or at risk of losing parental care in Romania. *Revista de cercetare si interventie socială*, 24, 41-71

Esping-Andersen, G. 2009, *Incomplete Revolution: Adapting Welfare States to Women's New Roles*, Cambridge, Polity Press

Ghetau, V. 2012. *Drama noastra deografica Populatia Romaniei la recensamantul din octombrie 2011*. Bucuresti, Compania

- Kvist, J. , Saari, J. , 2007. The Europeanisation of social protection: domestic impacts and national responses in Kvist, J. , Saari, J. (editors), *The Europeanisation of social protection*, The Policy Press, 229-248
- Kuronen, M. 2010, *Research on Families and Family policies in Europe State of the Art*, Commission of the European Communities Research Directorate-General
- <http://www.mmmeurope.org/ficdoc/FAMILYPLATFORM-Final-Report-04-2011.pdf>
- Luca, C. 2014. *Expertiza psihologica a copilului abuzat/neglijat*, Hamangiu, Iasi
- Mihalache, F. 2011. Calitatea vietii comunitare, in Marginean, I. ; Precupetu, I. (editors). *Paradigma calitatii vietii*, Bucuresti, Editura Academiei Romane, 131-140
- Muresan, C. 2014. Postponement of Motherhood in Romania: The Role of Educational Attainment. *Revista de Cercetare si Interventie Sociala*, 47, 137-149
- Neamtu, N. 2007. *Succes si esec in plasamanetul familial, in contextul reformei sistemului de protectie a copilului din Romania*, Cluj-Napoca, Accent
- Pânzaru, C. , Tomită, M. 2013. Parent Involvement and Early School Leaving. *Revista de Cercetare si Interventie Sociala*, 40, 21-36
- Popescu, R. ; 2009. *Introducere in sociologia familiei Familia romaneasca in societatea contemporana*, Iasi, Polirom
- Rotaru, T. , 2009, *Demografia si sociologia populatiei*, Iasi, Polirom
- Stănescu, I. 2014. Romania: a non-interventionist family support policies? *Mediterranean Journal of Social Sciences*, vol. 5, no. 19, august 2014, pp. 778-783
- Stănescu, S. M. ; 2006, Modelul social european, in Zamfir, C. ; Stoica, L. (coordonatori), *O nouă provocare: dezvoltarea socială*, Polirom, Iași, 2006
- Stănescu, S. M. 2013, *Statul bunăstării între supraviețuire, reformă și integrare europeană*, București, ProUniversitaria
- Stănescu, S. M. 2014. *The impact of the EU Accession of ast European countries on their institutional shape of social policy in volumul ПАРТНЕРСТВО ВО ИМЯ БЛАГОПОЛУЧИЯ, Partnership for the Welfare, Belarus*, 183-197
- Stănescu, S. M. ; Nemtanu, M. ; 2015. Family benefits in member states of the European Union: a comparative perspective (in print)
- Tomita, M. 2014. Developing Alternative Understandings of Conflicts That Involve Delinquent Children through Life Space Crises Intervention. *Revista de Cercetare si Interventie Sociala*, 44, 67-85
- Turluc, M. , N. ; Marici, M. , 2013, What do Romanians Parents and Adolescents Have Conflicts about?, *Revista de Cercetare și Intervenție socială*, vol. 42/ september 2013, pp. 28-49
- Vaughan-Whitehead, D. , 2004. *EU Enlargement versus Social Europe?, The Uncertain Future of the European Social Model*, Edward Elgar Publishing Limited, USA
- Vlase, I. 2014. L'impact de la crise sur la vie des chômeurs, *Revista Calitatea Vietii*, XXV, nr. 3/2014, 235-258
- Vonica Răduțiu, S. , (editor), Băjenaru, C. , Doboș, C. , Nițulescu, D. C. , Popescu, R. , Stoica, L. , 2004. *Aderarea României la Uniunea Europeană: impactul asupra statului bunăstării românesc*, Academia Română, nr. 122-123,
- Uzlau, C, Nicolae-Balan, M. ; Radu, B. M. 2009, Tendinte pe plan mondial in domeniul public de sanatate, in Albu, L. ; Nicolae-Balan, M. (editors) *Sistemul public de sanatate si cresterea economica*, Bucuresti, Expert, 15-93

Annex 1: Duration of maternity/paternity leave in EU-28 member states

Source: MISSOC data base, 1<sup>st</sup> of January 2014

Country	Before birth		After birth	
	Maternity	Paternity	Maternity	Paternity
Austria	8 weeks (before + after)		8 weeks /12 (premature, multiple birth or Caesarean)	
Belgium	6 weeks (1 compulsory)/8 (multiple births)		9 mandatory weeks (+remained prenatal)	10 days
Bulgaria	410 days (45 before + after)		410 days (before + after)	15 days <sup>1</sup>
Croatia	28 days/45 days (complications)		6 months <sup>2</sup>	
Cyprus	18 weeks <sup>3</sup> (before + after)		18 weeks <sup>4</sup>	
Czech Republic	28 weeks <sup>5</sup> /37 days (multiple births)		28 weeks <sup>6</sup> /37 weeks (multiple births)	
Denmark	4 weeks		14 weeks	2 weeks <sup>7</sup>
			32 weeks before the 9th birthday of the child	
Estonia	140 (before 30 days + after)	10 days <sup>8</sup>	140 days (before + after)	10 days
Finland	105 days (before 30-50 days + after)		105 day (55-75 days after)	54 days <sup>9</sup>
			158 days <sup>10</sup>	
France	6 weeks + 2 (pathological pregnancy)		10 weeks	11 days <sup>11</sup>
	8 weeks (the 3 <sup>rd</sup> child)		18 weeks (3 <sup>rd</sup> child)	18 days (multiple births)
	12 weeks (twins) 24 (multiple births)			
Germany	6 weeks/12 (premature, multiple)		8 weeks	
Greece	119 days (56 before + 63 after)		119 days	
Hungary	24 weeks (4 optional before)		24 weeks	5 days
Ireland	26 weeks (at least two before)		26 weeks (at least four after)	

<sup>1</sup> For eligible at least 12 months of insurance fathers

<sup>2</sup> Including 70 compulsory days after which father can continue

<sup>3</sup> Beginning the 9<sup>th</sup> to 2<sup>nd</sup> weeks before expected birth

<sup>4</sup> An extension of maximum six weeks for hospitalized child

<sup>5</sup> Beginning the 8<sup>th</sup> to 6<sup>th</sup> weeks before expected birth

<sup>6</sup> Shorter 14 weeks leave in total including six weeks after if the child dies

<sup>7</sup> Continuous weeks within the 14 weeks after birth

<sup>8</sup> Within the period of two months before the estimated date of confinement or two months after the birth of a child.

<sup>9</sup> Excluding Sundays. The father can take 1–18 days as paternity leave after the child is born during the maternity and parental leave.

<sup>10</sup> Parental leave excluding Sundays. In case of multiple births 60 days are added for each additional child.

<sup>11</sup> Within the four months after the birth

Country	Before birth		After birth	
	Maternity	Paternity	Maternity	Paternity
Italy	5 months (1or 2 before + after)		5 months (before + 3 to 4 months)	1 compulsory day <sup>1</sup> + 2 days <sup>2</sup>
Latvia	112 days (56 before + after) <sup>3</sup>		112 days (before + 56 days after)	10 calendar days
Lithuania	70 calendar days		56 days <sup>4</sup>	1 month
Luxembourg	8 weeks		8 weeks <sup>5</sup>	2 days
Malta	14 weeks (maximum 9 weeks before + after)		At least 5 weeks	2 days
			4 weeks (an additional paid maternity leave benefit)	
Poland	20 weeks (6 before /8 for hospitalisation)		20 weeks <sup>6</sup>	2 weeks <sup>7</sup>
			6 weeks/8 (multiple) (an additional maternity leave)	
Portugal	30 days <sup>8</sup>		6 weeks compulsory	10 days <sup>9</sup> + 10 days <sup>10</sup>
			3 months (extended parental leave)	
Romania	63 days <sup>11</sup>		63 days (42 compulsory)	5 days + 10 days <sup>12</sup>
Slovakia	6 - 8 weeks		34 weeks <sup>13</sup> /37 (single mothers)/43 (multiple births)	
Slovenia	105 days (28 days before + after)		105 days (before + 77 after)	15 days <sup>14</sup> + 75 days <sup>15</sup>
Spain			16 weeks <sup>16</sup>	4 weeks
Sweden	17 weeks		7 weeks	

<sup>1</sup> To be claimed within five months after the child's birth

<sup>2</sup> In replacement of maternity paid leave

<sup>3</sup> 14 additional days of leave and benefit for women who have received continuous medical care commencing before the 12th week of pregnancy. Further 14 days are available for complications during pregnancy, delivery or post-natal period and for multiple births.

<sup>4</sup> In cases of complicated deliveries or multiple birth, benefits are payable for 70 days after delivery. In case of premature childbirth (more than 22 weeks of pregnancy) benefits are paid for 28 days after delivery (if the child survives: for 120 days).

<sup>5</sup> Supplement of four weeks for nursing mothers and in case of premature birth or multiple births.

<sup>6</sup> Minus pre-natal weeks and varies to 31 weeks (twins), 33 weeks (triplets), 35 weeks (quadruplets), 37 weeks (quintuplets or more)

<sup>7</sup> To be taken until the child is 12 months of age.

<sup>8</sup> Part of initial parental leave 120 or 150 consecutive days

<sup>9</sup> Of which five days must be taken consecutively immediately after birth and five days during the subsequent 30 days

<sup>10</sup> Consecutive or not but to be taken during the initial parental leave of the mother

<sup>11</sup> Periods may be compensated between according to medical advice and the option of the beneficiary, provided the period after confinement is longer than 42 days.

<sup>12</sup> Additional ten days if father graduates a child-care course

<sup>13</sup> If the child dies, the total duration is shorter, but not less than 14 weeks and cannot be terminated in the six weeks following the delivery

<sup>14</sup> During the first six months of the child's life

<sup>15</sup> To be used until the child's 3<sup>rd</sup> birthday, during which the state pays social security contributions for the father.

<sup>16</sup> Two extra weeks per child as from the second child in case of multiple birth; and birth, of a disabled child. If both parents work, ten weeks may be granted to the father.

Country	Before birth		After birth	
	Maternity	Paternity	Maternity	Paternity
The Netherlands	16 weeks (compulsory 4 to 6 before )		16 weeks (10 to 12)	2 days
United Kingdom	52 weeks (since 11 <sup>th</sup> before and after)		52 weeks (before and after)	1 or 2 weeks <sup>1</sup>

<sup>1</sup> Can be taken within 56 days of the date of birth, or if the child is born early, within the period from the actual date of birth up to 56 days after the first day of the week in which the birth was expected.



---

## Teacher's Suggestions for Recycling and Sustainable Environment: Reflections on Diaries<sup>1</sup>

**Assoc. Prof. Dr. Dilek ERDURAN AVCI**

Mehmet Akif Ersoy University, Education Faculty, Science Education Department, Burdur, TURKEY dilek924@gmail.com

**Assist. Prof. Dr. Huriye DENİŞ ÇELİKER**

Mehmet Akif Ersoy University, Education Faculty, Science Education Department, Burdur, TURKEY huriyedenis@mehmetakif.edu.tr

### Abstract

*There has been great increase in the amount of waste as a result of consumption habits of humankind. Having a sustainable environment is possible by recycling and providing the reuse these wastes. But it is encountered with some conditions which may negatively affect all living creatures because of leaving wastes into the nature without any process. Education of sustainable environment has a key role in reducing these problems. Science is one of the lessons which may give this education in Turkey. In this view science teachers should have a well-informed, conscious and positive attitude about subjects of recycling and sustainable environment. Based on this matter, a project named "look forward and recycle: Recyclist teacher" was performed. This project was actualized in Burdur between 17-23 August 2014 with the support of the Scientific and Technological Research Council of Turkey (TÜBİTAK) and Mehmet Akif Ersoy University. Totally 23 activities were applied within the project. During this process, teachers who attended this project kept diaries about assigned subjects when they completed their activities. Diary subjects were determined in a way to allow participants for expressing their feelings and thoughts related with the activity content of each day. Throughout five days, suggestions of participants for recycling and sustainable environment in written diaries were analyzed. When diaries are examined it is seemed that suggestions of science teachers are collected under five main categories for recycle and sustainable environment. These are precautions on the basis of state, economic extent, education, written and visual media, and precautions on the basis of nature. Results of research are considered to be a guide for future works.*

**Keywords:** teacher's suggestions, recycling, sustainable environment, diaries

### 1. Introduction

People and environment they live in are an inseparable whole. People's interaction with nature is inevitable within the scope of this wholeness. But this interaction has been turning solution into tough problem when it is unidirectional for only human interests without considering nature (Kocatas, 2003). It is remarkable that struggle between human and nature will turn into power struggle between ecology and economy and as a result of these people will eventually destroy themselves (Atasoy, 2006). The negative effects of human activities on nature are increasing rapidly (Yıldız, Sipahioğlu and Yılmaz, 2005; Kışlalıoğlu and Berkes, 2003). People, who think that consumption will especially increase life quality, have been consuming much more (Kilbourne, 2006), the more consumption increases the more waste increases and it will cause more environmental pollution. Wastes, which are one of the causes of these negative effects, have grown to such an extent that they threaten the lives of our generation and the future generations (Güler and Çobanoğlu, 1994; Özek, 1994; Ongley, 1996).

Recycling which is one of the most important attitude for environment is the process that puts various waste materials (glass, paper, aluminum, cell, motor oil, accumulator, concrete, organic wastes and electronic wastes etc. ) into recycling

---

<sup>1</sup> Data of this work was prepared during the process of the project Look Forward and Recycle: Recyclist Teacher with the number 213B704 that was supported within the scope of TÜBİTAK (The Scientific And Technological Research Council Of Turkey) 4004 – Nature and Science Schools in 2014.

by turning into secondary material with various physical and/or chemical treatments (Buyuksaatci, Kucukdeniz, and Esnaf, 2008). Recycling contributes to protection of natural sources in environment and to reducing the amount of solid waste. Recycling contributes as economically and environmentally besides reducing the amount of solid waste (Oom Do Valle, Reis, Menezes, and Rebelo, 2004). Consequently it is seemed as an important part of sustainable future (Hopper and Nielsen, 1991; Oskamp, 1995; Valle, Reis, Menezes, and Rebelo, 2004).

According to expressions of Kaya and Tomal (2011) in their works, sustainability was used for the first time as political and economic concept in 18th century by Georg Ludwig Harting. The concept was described as “sustainable use of resources” in Rio de Janeiro United Nations World Environment Summit Meeting in 1992. In the sense of protecting environment the sustainability can be described as displaying attitude which can keep environment in its most natural shape, and being in activities of recycling environment which is damaged or vanished as a result of human activities (Yavuz, 2010). Sustainable development has been addressed both economic growth and ecological balance and been described as being attentive to provide future generations’ necessities in today without risking their necessities in the future (Karalar and Kiraci, 2011).

Sustainable environment and efficient recycling can only be obtained by focusing on educated consumption attitudes. Individuals have duties and responsibilities in reducing the amount of wastes, separating wastes from its sources and recycling. This can only be managed by individuals with conscious, sensitive and awareness (Karatekin, 2003).

Education has an important role in raising individuals with conscious, sensitive and awareness about sustainable environment and recycling. Science class is one of those classes which this education may be given. In the sense of both vision indicated in the science class curriculum of Ministry of National Education (2013) and acquisitions in its content, Science class and science teachers have an important role in raising a generation adopted recycling. In order to perform this role science teachers should be well-informed and have positive attitude for waste and recycling. Because teachers have an important place in students’ information source about recycling (Çimen and Yılmaz, 2012). Based on this, “Look Forward and Recycle: Recyclist Teacher” project, which was supported within the scope of Scientific and Technological Research Council of Turkey (STRCT) 4004 – Nature and Science Schools, was actualized by science teachers. The project comes to the forefront with an activity program including information and application of participants, as both individuals and teachers, about sustainable environment and recycling. The aim of this work is to present suggestions of science teachers, participated this project, for sustainable environment and recycling.

## 2. Method

This work is a qualitative research.

The participants comprise 20 science teachers who work in secondary schools from different provinces of Turkey. 13 female and 7 male teachers participated to the project. The participants were chosen according to the information they have provided on application form. In application form, participants were asked about their seniority, graduated school and department, province which they are living, whether allergic and chronic illness they have or not, what they think and what they do relating to waste and recycling, reasons why they want to get involved in this project. Participants were selected according to assessment criteria. Participants’ willingness to participate in the project was also taken into consideration.

Teachers’ diaries are used as data collection tool. Teachers’ suggestions for recycling and sustainable environment are tried to be presented with a content analysis from their expressions in diaries. Themes and sub-themes obtained as a result of content analysis are supported by quoting teachers’ expressions in diaries. Nicknames of participants are used instead of their names while quoting.

### 2.1. The project of “Look forward and recycle: Recyclist teacher”

“Look forward and recycle: Recyclist teacher” project was prepared for gaining this awareness and it was supported by TÜBİTAK 4004 Nature education and science schools’. Project conducted between 17-23 August 2014. The primary purpose of this project was to show the participants the effects of wastes on human, animals, plants and the others; by getting them to involve to the recycling activities. Another purpose of this project was to improve the scientific understanding of the participants on this subject and finally make them gain a positive attitude towards recycling.

In this project 23 different activities were carried out. These activities were “Meeting (creative drama), Is The Life Possible Without Waste?, Waste And Creative Abilities, Writing Time: Diary, Track Of Wastes, Biodegradation, How To Enable The Conversion Of Biodegradations, A Trip To Hobby Garden, Making Compost And Having Biogas, Effect Of Domestic And Agricultural Waste To The Lake, Livings Around The Water Resources I-II, Where Is Our Waste Going?, Designing Education Activities, Presentation And Discussion About Educational Activities Which Were Designed, A Trip to History I-II, We Remember Our Experience, Sharing Time.

During this process teachers wrote diaries about assigned subjects when they completed their activities. Diary subjects are determined in a way which allows participants for expressing their feelings and thoughts about activity content of each day. Diaries of participants are examined with respect to teachers’ suggestions for recycling and sustainable environment.

### 3. Findings

When science teachers’ suggestions for recycling and sustainable environment in diaries were examined, five main themes showed up. These themes are precautions on the basis of state, economic extent, education, written and visual media, and precautions on the basis of nature. In table-1 themes which took place in teachers’ diaries and its distribution are given.

**Table 1.** Themes which took place in teachers’ diaries and its dissemination with respect to recycling and sustainability.

Themes	N
Precautions on the basis of state	14
Economic extent	14
Education	13
Written and Visual Media	7
Precautions on the basis of nature	4

#### 3.1. Precautions on the basis of state

Most of science teachers, participated the project activities, mentions about precautions on the basis of state for sustainable environment in their diaries. As regarding these precautions sub-categories are that penal sanction should be set, legal regulations should be made, incentive pays should be given, awarding should be actualized, recycling and sustainability should be turned into government policy. Some of the expressions in teachers’ diaries are like:

*As long as there are not hefty sentences, I do not think that waste problem will end. (Inci)*

*In order to turn waste materials into energy industrialists should be promoted and facilities which will be established should be excised if it is necessary. (Doruk)*

*I think that amount of waste production should be reduced in order to solve Turkey’s waste problem. I also consider this situation should be a government policy. (Ayse)*

*.... municipalities, district governorship, governorates and government should handle with this situation. Subjects related to recycling-regaining of environment and wastes should be in regulated constitution provisions. (Nil)*

*Factories which use wastes should be established in Turkey and these should be promoted with state incentives. (Meltem)*

*We should take this subject to parliament and present our suggestion to representatives. . Parliament should promote people by making law about this matter. (Okan).*

*Politicians may promote people to recycle their wastes by making legal regulations and establishing foundations to follow-up. People may earn some financial income with respect to their wastes or collecting wastes may be provided by presents. (Ilhan)*

*...Immigration from undeveloped nations should be prevented. Migrations which overburden cities should be prevented. (Zeki)*

*For example, just saying "recycling products such as plastic, glass, paper and cell should be collected in schools" is not enough. Collected wastes should be taken in periods by municipalities. (Gorkem)*

### 3.2. Economic extent

Science teachers who are project participants emphasize on economic extent for providing recycling in aimed level and sustainable environment. An adequate budget is needed in order to provide enough recycling banks, to develop facility and systems of recycling, to support scientific research and projects related to the subjects. Some expressions of teachers related to economic extent are like:

*State institutions and organizations should be mobilized and enough recycling banks should be put in related places, adequate budget should be formed, and sanctions should be made. (Nehir)*

*If we arrange funds in environment projects for country wide person and organizations, we can promote them. (Orhan)*

*Adequate containers of metal, glass, cell and domestic wastes should be put in neighborhoods. (Zehra)*

*Adequate budget should be formed in order to make recycling boxes, facilities, collect units, and facilities of waste-water utilization. (Ayse)*

*... interdisciplinary works and projects should be given an opportunity. (Ilhan)*

*Factories in which recycling materials can be recycled should be established in every city. (Hasan)*

*In schools, houses, workplaces, hospitals there should be enough waste boxes which we can categorize our wastes. (Gunay)*

### 3.3. Education

Most of science teachers stated that education is important for sustainability. In education category they emphasized that there should be classes related to the subject, conscious consumption attitude should be developed, individuals should gain a habit to collect wastes separately, and community should become conscious. They also mentioned about educations of families, children, adults and moral educations. Some expressions of teachers about education are like:

*Ending Turkey's garbage can only be possible with completing related education and lack of conscious. Community can only become conscious with education. (Evren)*

*People should be informed about waste material and how these materials damage environment. In this respect schools should be given education and if it is necessary "recycling classes" should be arranged. (Doruk)*

*I firstly say that education is an obligation to solve this problem. (Ayse)*

*Ending garbage is possible by informing people...Informing people and especially students is so important. (Inci)*

*All people should become conscious. (Damla)*

*Families should be informed about recycling. (Meltem)*

*In our country citizens should become conscious from early ages. (Zeliha)*

*We can start our struggle by ending garbage in the head of children in home and students in school. After they became conscious we had already brought solutions slowly. Our children produce so original ideas that I believe they will start the biggest development. In time, people, families will become conscious. After the country will become conscious and there will not be garbage or waste problem in Turkey. (Gunay)*

*The biggest lack in the management of waste is unconsciousness of families. As a beginning families should become conscious and applications should be made about this matter. When these applications became a habit, it would reflect on children. There may be a lesson about environmental consciousness and children can be informed about this subject. (Munevver)*

*...it should be told that being happy with consumption is not normal. (Irmak)*

*Students should be informed not to use gift package and people should be promoted to use rummage materials. Open buffet, all in systems should be either removed or limited. (Hasan)*

### 3.4. Written and Visual Media

Some of science teachers who are project participants emphasize on the importance of written and visual media for recycling and sustainable environment. In this view, they stated that press, social media, poster, public services or cartoons may be used, campaigns may be arranged, and also advertisements including negative consumption attitudes should be avoided. Some of teachers' suggestion expressions for written and visual media are like following:

*...cartoons should be used to educate young in this way. Very popular cartoon hero would be a good garbage collector. In this way a community who collect garbage will come out. (Damla)*

*In houses and streets precautions which are galvanizer for separating wastes should be taken. For this purpose written and visual media can be benefitted. (Meltem)*

*Several people are not even aware of how wastes, they threw, pollute environment. So awareness should be created by putting up a poster where people can easily see. (Ilhan)*

*Public service ad and reading texts in the books should be used in order to make people conscious. (Gunay)*

*Campaigns may be initiated ("develop your neighborhood with your own waste") like building park, astroturf, wedding saloon for neighborhood. Treeplanting campaigns: build your own forest. Just like a tree for a kilo of cell, a tree for a kilo of metal, bring paper and take your tree. (Zehra)*

*...by creating awareness a consciousness can be created on people about recycling through putting up posters at where people may see. (Orhan)*

*...reducing pollution may be provided by maintaining campaigns until creating a conscious. (Gorkem)*

### 3.5. Precautions on the basis of nature

Few of science teachers offered suggestions for sustainable environment with precautions on the basis of nature such as creating protection zones, protecting water sources, planting plants which do not consume much water. Some expressions of teacher are below:

*Planting plants which do not need much water like rose, levanter will be so useful to the process. (Ayse)*

*Water sources should not be hired to companies for income, city wastes should not be left on the way of these sources. (Inci)*

*...protection areas should be created. (Ibrahim)*

#### 4. Results and Discussion

When diaries of teachers, who participated the project “Look Forward and Recycle: Recyclist Teacher” and wrote throughout the project, are examined, their suggestions related to recycling and sustainable environment are collected under five main categories: (1) precautions on the basis of state, (2) economic extent, (3) education, (4) written and visual media, (5) precautions on the basis of nature. Legal regulations, laws and common policies, serving services such as mass transportation and collecting containers for recycling, reaching opportunity for eco-friendly alternative products, role of environmentalist groups in social consciousness, advertisements, press and news about the subject can be counted between exterior sustainable factors which affect individual attitudes (Kilbourne et al. , 2002; Stern, 2000). As a result of analysis which science teachers presented, it is seemed that content of reached categories and sub-categories includes exterior factors which effect individual attitudes mentioned above.

For sustainable environment and recycling most of science teachers emphasized on precautions on the basis of state that penal sanctions should be set, legal regulations should be made, incentive pays should be given, awarding should be actualized, recycling and sustainability should be turned into government policy. When the effects and necessities of public support on creating aimed effect of legal regulations such as sanctions, penalties and taxations which is applied to reduce overconsumption of sources within property are considered, the importance of role of local governments under environmental management comes again to forefront (Sengul, 2002; Brown and Cameron, 2000). Local governments contribute to protecting and healing environment by providing attendance of individuals into environmental management (Üste, 2005). Örten (2009) listed down the main duties of local governments on individual consumption attitudes as: creating environmental consciousness, presenting required substructure services, following up incentive policies and performing legal sanctions. A sustainable system consists of political responsibility and attendance (Holmberg and Sandbrook, 1992). As regarding legal regulations and sustainable government policy Colakoglu (2010) emphasized that countries’ creating unique environment right in national constitutes and giving this right a place is important for sustainable environment. When it is considered that sustainable environment is connected with sustainable consumption; Veenhoven (2004), who said that sustainable consumption both takes place in political decision making bodies and is a fact based on convincing consumers with powerful tool, emphasized on the importance of decision makers. According to Cooper et al. (1998), governments can direct consumption attitudes of individuals with campaigns, services, incentives or sanctions aimed at individuals as well as providing an environmental development on consumption attitudes as a result of legal sanctions they applied. As a result of meetings which is made to present the role of local governments on individual sustainable consumption, Örten (2009) stated that they indicated the necessity of making laws and consolidating penal sanctions in order to prevent individual attitudes caused pollution and damaged environment after given required education to people about environment and constituted substructure. Correspondingly science teachers emphasized on penal sanctions and legal regulations. Some of science teachers state that immigration which overburdens cities and countries should be prevented and increasing of population is something negative for sustainability. In other words Schaefer and Crane (2005) stated that the rate of increase in population should be reduced as a way of reducing high rate in consumption.

Again most of science teachers emphasized on economic extent for providing recycling at aimed level and sustainable environment. An adequate budget is needed for providing enough recycling banks, developing recycling facilities and systems, supporting scientific research and project related to the subject.

Another factor which science teachers emphasize for sustainable environment is education. They emphasized that there should be classes about environmental education, conscious consumption attitude should be developed, individuals should gain a habit to collect wastes separately and people should become conscious. They also mentioned about education of families, children, adults and moral education as related do the subject. Education is an important extent for sustainable environment when it is considered that environmental education is important to understand habits such as understanding, skill, attitude and thought about environment, to understand natural relations took place between human, society and natural systems and to know how we can make these relations more sustainable, and this system consists of the process which is being successfully active, helps to make right decisions about environment and turns these decisions into eco-friendly attitudes (O’Brien, 2007; Kışoğlu, 2009). One of the subcategories of education, which came out as a result of teachers’ suggestions, is to develop a conscious consumption attitude. Consumption habits of individuals who constitute the society directly or indirectly cause the consumption of natural sources and deterioration of ecological environment (Munksgaard et al. , 2002). In order to make people gain sustainable consumption habits Karalar and Kiraci (2010) mentioned about implementations as product sharing systems should be created, individuals should be encouraged to display sharing habits

against buying products, recycling boxes should be put in several places of city, we should be organized to collect used dresses, book etc. , bicycle roads should be built in the city. It is seemed that there are some similar examples between science teachers' suggestions. It is seemed that teachers' expressions about making people conscious are parallel with expressions of Karatas and Aslan (2012) that family, education organizations, mass communication tools and nongovernmental organizations have important roles in developing environmental conscious.

A part of science teachers who are project participants emphasized on written and visual media for recycling and a sustainable environment. At this stage, they have indicated that press, social media, posters, public service ads or cartoon films can be used and campaigns can be formed. They also indicated that advertisements including negative consumption attitudes should be prevented. Such as to support the using of written and visual media Selanik Ay (2010) stated that students' benefiting from media product in gaining environmental conscious contributes to having information about environment, to gain environmental conscious, to develop their skills in searching, to realize environmental issues, to keep them being up to date, to make learning process an interesting thing, and to increase their sensitiveness to environment. Alim (2006) stated that according to the result of a research made in the United States of America students in primary and middle schools gets their environmental information mostly from written and visual media, then school and last their family and friends. The role of written and visual media on environmental education which science teachers emphasized in their suggestions has been presented also by researches. According to Barkan and Eroglu (2004), educators use written and visual media in education process in order to make learning permanent. There are hundreds of works which tests educational values of pictures, television, slide, film strip, records and other educational media. The results obtained from these tests, effective using of these kind of media has a great value in education process. Although science prospective teachers indicated the positive aspect of written and visual media, they have also mentioned to avoid from advertisements including negative consumption attitudes. Karalar and Kiraci (2011) emphasized the negative effects of advertisements by stating that cultural norms, created with the support of advertisement, cause to make wrong decisions in consumption which is based upon lack and partial information of consumers.

A few of science teachers offered suggestions for sustainable development with precautions on the basis of nature such as creating protection areas, protecting water sources and planting plants which do not need much water. One of the important points of sustainable consumption is that we need to provide our necessities in today by considering the opportunities of next generations to provide their own necessities without overconsuming natural sources and destroying environment (Mortensen, 2006). Sustainable consumption means reducing used natural sources and protecting in developed countries at least (Cooper, 2005).

As a result of this work, most of suggestions which reflect on diaries of science teachers, participated the project about recycling and sustainable environment, are parallel with related literature in great parts. It is considered that research results will be pathfinder for new works. Also research results may be examined by executive units, education organizations, parents, written and visual media organizations.

Several works present that projects have positive effects (Erduran Avcı, Deniz Çeliker, 2015; Balkan Kıyıcı, Atabek Yiğit, Selcen Darçın, 2014; Balım, Deniz Çeliker, Türkoğuz and Kaçar, 2013; Tekbıyık, Şeyihoğlu, Sezen Vekli and Birinci Konur, 2013; Karataş and Aslan, 2012; Cappellaro, Ünal Çoban, Akpınar, Yıldız and Ergin, 2011; Erdoğan, 2011; Keleş, Uzun and Varnacı, 2010; Güler, 2009; Ozaner, 2004).

In this sense, performing projects with the content of sustainable environmental education is important. It is obvious that a necessity giving an importance to nature education projects, which are supported by various organizations to develop regarding with recycle and to create a sustainable natural environment, comes out (Erdogan, 2011; Ulucinar Sagir, Aslan and Cansaran, 2008). It can be stated that similar projects with teacher-centered whose aims are to raise next generations or with different participant in its center should be actualized and disseminated in order to provide important gains.

## 5. References

Alim, M. (2006). Environment and environmental education in primary school in turkey within the process of the membership of European union, *Kastamonu Education Journal*, 14 (2), 599-616.

Atasay, E. (2006). Çevre için eğitim ve çocuk doğa etkileşimi, Ezgi Kitapevi Yayınları, Bursa.

- Balım, A. G. , Deniz Çeliker, H. , Türkoğuz, S. , & Kaçar, S. (2013). The effect of reflections of science on nature project on students' science process skills, *Journal of Research in Education and Teaching*, 1 (2), 149-157.
- Barkan, M. , & Eroğlu, E. (2004). Eğitim iletişimde çağdaş ortamlar: iletişim bir sorun kaynağı mi yoksa çözüm seçeneği mi?. *The Turkish Online Journal of Educational Technology*, 3 (3), 115-123.
- Balkan Kırıyıcı, F. , Atabek Yiğit, E. , & Selcen Darçın, E. (2014). Investigation of Pre-Service Teacher's Opinion and Environmental Literacy Level Change with Nature Education, *Trakya University Journal of Education*, 4 (1), 17-27.
- Büyüksaatçı, S. , Küçükdeniz, T. , & Esnaf, Ş. (2008). Determining location of recycling plants with gustafsonkessel algorithm-convex programming hybrid model-based simulation. *İstanbul Ticaret Üniversitesi Fen Bilimleri Dergisi*, 7 (13), 1-20.
- Brown, P. M. , & Cameron, L. D. (2000). What can be done to reduce overconsumption?. *Ecological Economics*, 32 (1), 27-41.
- Cappellaro, E. , Ünal Çoban, G. , Akpınar, E. , Yıldız, E. , & Ergin, Ö. (2011). Yetişkinler için yapılan uygulamalı çevre eğitime bir örnek: su farkındalığı eğitimi, *Journal of Turkish Science Education*, 8 (2), 157-173.
- Cooper, P. J. , Brady, L. P. , Hidalgo-Hardeman, O. , Hyde, A. , Naff, K. C. , Ott, S. J. , & White, H. (1998). *Public administration for the twenty-first century. USA: Harcourt Brace & Company.*
- Cooper, T. (2005). Slower consumption reflections on product life spans and the "throwaway society", *Journal of Industrial Ecology*, 9 (1-2), 51-67.
- Çolakoğlu, E. (2010). Haklar söyleminde çevre eğitiminin yeri ve Türkiye'de çevre eğitiminin anayasal dayanakları. *TBB Dergisi*, 88, 151-171.
- Çimen, O. , & Yılmaz, M. (2012). Recycling knowledge, behaviors, and attitudes of primary school students, *Journal of Uludağ University Faculty of Education*, 25 (1), 63-74.
- Erdoğan, M. (2011). The effects of ecology-based summer nature education program on primary school students' environmental knowledge, environmental affect and responsible environmental behavior, *Educational Sciences: Theory & Practice*, 11 (4), 2223-2237.
- Erduran Avcı, D. , & Deniz Çeliker, H. (2015). The effect of recycler teachers project on science teachers' attitude towards waste and recycling. *Journal of Research in Education and Teaching*. 4 (1), 215-224.
- Güler Ç. , & Çobanoğlu Z. , (2004). Katı atıklar, T. C. sağlık bakanlığı sağlık projesi koordinatörlüğü yayını, *Çevre Sağlığı Temel Kaynaklar Dizisi No: 29*, Ankara.
- Güler, T. (2009). The Effects of an Ecology Based Environmental Education on Teachers' Opinions about Environmental Education, *Education and Science*, 34 (151).
- Holmberg, J. , & Sandbrook, R. (1992). Sustainable development: what is to be done? Making development sustainable: redefining institutions, policy, and economics. (Ed. J. Holmberg). *International Institute for Environment and Development*, s. 19-38, Washington, D. C. Island Press.
- Hopper, J. R. , & Nielsen, J. M. (1991). Recycling as altruistic behavior: Normative and behavioral strategies to expand participation in a community recycling program, *Environment and Behavior*, 23 (2), 195-220.
- Karalar, R. , & Kiracı, H. (2010). A research on class teachers related to determining the effects of consumers' personal values on sustainable consumption behavior. *İşletme Araştırmaları Dergisi*, (2), 79-106.
- Karalar, R. , & Kiracı, H. (2011). Sustainable consumption notion as a solution to ecological problems, *Dumlupınar University Journal of Social Sciences*, 30, 63-76.
- Karataş, A. , & Aslan, G. (2012). The role of environmental education in gaining environmental awareness for elementary school students: the sample of ecology based summer camp project, *Zeitschrift für die Welt der Türken/Journal of World of Turks*, 4 (2), 259-276.



- Karatekin, K. (2013). Developing a scale to measure pre-service teachers' attitudes towards solid waste and recycling: a validity and reliability study, *International Eurasian Journal of Social Sciences*, 4 (10), 71-90.
- Kaya, M. F. & Tomal, N. (2011). Examination of the social sciences education program in the frame of sustainable development training, *Journal of Educational Sciences Research*, 1 (2), 49-65.
- Keleş, Ö. , Uzun,N. & Varnacı, (2010). The change of teacher candidates" environmental consciousness, attitude, thought and behaviors with nature training project and the assessment of its permanence, *Electronic Journal of Social Sciences*, 9 (32), 384-401.
- Kışlalıoğlu, M. & Berkes, F. (2003). *Ekoloji ve çevre bilimleri. Remzi Kitabevi. Büyük Fikir Kitapları Dizisi: 95. İstanbul.*
- Kışoğlu, M. (2009). Investigation of the effect of the teachers of the student-centered teaching environmental literacy levels, Unpublished doctoral dissertation, Atatürk University, Institute of Science: Erzurum.
- Kilbourne, W. E. , Beckmann, S. C. , & Thelen, E. (2002). The role of dominant social paradigm in environmental attitudes: A multinational examination, *Journal of Business Research*, 55, 193-204.
- Kilbourne, W. (2006). The role of the dominant social paradigm in the quality of life/environmental interface, *Applied Research in Quality of Life*, 1, 39-61.
- Kocataş, A. (2003) *Ekoloji ve çevre biyolojisi, Sekizinci Baskı, Ege Üniversitesi Basımevi, Bornova, İzmir.*
- Milli Eğitim Bakanlığı. (2013). *Fen bilimleri dersi öğretim programı. Ankara: Talim ve Terbiye Kurulu Başkanlığı.*
- Mortensen, L. F. (2006). Sustainable household consumption in Europe?, *Consumer Policy Review*, 16 (4), 141.
- Munksgaard, J. , Wier, M. , Lenzen, M. , & Dey, C. (2002). Indicators for the environmental pressure of consumption. Life-cycle Approaches to Sustainable Consumption Workshop Proceedings, Interim Report, International Institute for Applied Systems Analysis, Laxenburg, Austria. (p. 171). [Online]Available: file:///C:/Users/pb6570b/Downloads/0f317531e28271d001000000%20(1).pdf (February 27, 2015).
- O'Brien, S. R. M. (2007). Indications of environmental literacy: using a new survey instrument to measure awareness, knowledge and attitudes of university aged students. Unpublished master thesis, Iowa State University: Iowa.
- Ongley, E. D. (1996). Control of water pollution from agriculture. *FAO Irrigation And Drainage*, 55, Roma.
- Oom Do Valle, P. , Reis, E. , Menezes, J. , & Rebelo, E. (2004). Behavioral determinants of household recycling participation the: Portuguese case, *Environment and Behavior*, 36 (4), 505-540.
- Oskamp, S. (1995). Resource conservation and recycling: Behavior and policy. *Journal of Social Issues*, 51 (4), 157-177.
- Ozoner, S. (2004). Türkiye'de okul dışı çevre eğitimi ne durumda? neler yapılmalı? V. Ulusal Ekoloji ve Çevre Kongresi, Abant İzzet Baysal Üniversitesi & Biyologlar Derneği, Bolu.
- Özek, E. (1994). Environmental pollution from agriculture and simulation studies. Unpublished master thesis, Ankara Üniversitesi Fen Bilimleri Enstitüsü: Ankara.
- Örten, T. (2009). The role of individual sustainable consumption behavior of local governments. *Cumhuriyet University Faculty of Arts and Social Sciences Journal*, 33 (2), 197-204.
- Schaefer A. , & Crane A. (2005). Addressing sustainability and consumption, *Journal of Macromarketing*, 25 (1), 76-92.
- Selanik Ay, T. (2010). Sosyal bilgiler dersinde çevre bilinci kazandırmada medya ürünlerinden yararlanmaya ilişkin öğrenci görüşleri. *International Eurasian Journal of Social Sciences*, 1 (1), 76-93.
- Stern, P. C. (2000). Toward a coherent theory of environmentally significant behavior. *Journal of Social Issues*, 56 (3), 407-424.
- Şengül, M. (2002). Çevre yönetimine halk katılımı yolu olarak belediye yönetimine halk katılımı. *Çağdaş Yerel Yönetimler Dergisi*, 11 (2), 25-40.

---

Tekbıyık, A. , Şeyhođlu, A. , Sezen Vekli, G. , & Birinci Konur, K. (2013). Influence of a science camp based on active learning on students, *International Journal of Social Science*. 6 (1); 1383-1406.

Uluçınar Sađır, Ş. , Aslan, O. , & Cansaran, A. (2008). The examination of elementary school students' environmental knowledge and environmental attitudes with respect to the different variables. *Elementary Education Online*, 7 (2), 496-511.

Üste, R. B. (2005). Yerel yönetimlerde demokratikleşme. *Türk İdare Dergisi*, 448, 49-60.

Valle, P. , Reis, E. , Menezes, J. , & Rebelo, E. (2004). Behavioral determinants of household recycling participation. *Environment and Behavior*, 36 (4), 505-540.

Veenhoven, R. (2004). Sustainable consumption and happiness, driving forces and barriers to sustainable consumption, *International Workshop, University of Leeds*. [Online] Available: <http://www2.eur.nl/fsw/research/veenhoven/Pub2000s/2004d-full.pdf> (February 16, 2015).

Yavuz V. A. (2010). Concept of sustainability and sustainable production strategies for business practices, *Mustafa Kemal University Journal of Social Sciences Institute*, 7, 63-86.

Yıldız, K. , Sipahiođlu, Ş. , Yılmaz, M. . (2007). Environmental science and education. *Türkiye. Gündüz Eğitim ve Yayıncılık*.

---

## How Sensitive are Indonesian Customers to Sexual Appeal Advertising? (a Study of the Axe TV Commercial, "Heaven on Earth")

**Diana Sari**

Department of Management & Business Padjadjaran University, Bandung, Indonesia

[diana.sari@fe.unpad.ac.id](mailto:diana.sari@fe.unpad.ac.id)

**Winton**

Department of Management & Business Padjadjaran University, Bandung, Indonesia

[officialwinton@gmail.com](mailto:officialwinton@gmail.com)

**Philip Trebilcock**

Department of Economics Business & Law La Trobe University, Bendigo, Australia

[p.trebilcock@latrobe.edu.au](mailto:p.trebilcock@latrobe.edu.au)

### Abstract

Previous studies have shown somewhat of a contradiction in the effect of sexual appeal advertising on purchase intention. This research aims to examine from an Indonesian perspective the consumer response to sexual appeal advertising and the subsequent purchase intention toward the products advertised. Through advertising, companies seek to be seen as the providers of creative and innovative products. Therefore company success increasingly relies on advertising appeal. One of these appeals is sexual advertising that is considered to be uniquely able to attract the attention of consumers and strengthen the brand with favorable associations. Such appeal eventually influences purchase decisions and stimulates purchase intention. This research uses quantitative methods through a consumer survey and simple regression analysis. Samples included 120 heterosexual men in the 15-24 year age group who reside in Indonesia's third largest city, Bandung. Results show that the consumer response to sexual appeal advertising of AXE is positive and consumer purchase intention of AXE products after watching the "Heaven on Earth" advertisements series is strongly positive. Sexual appeal advertising is shown to have a statistically significant positive effect on Indonesian consumers' purchase intentions.

**Keywords:** Advertising, Sexual Appeal Advertising, Purchase Intention

### Introduction

Appropriate advertising plays an increasingly significant role in the marketing activities of companies facing industry competition. Advertising has been considered one of the most effective means of providing information on company products and in the attraction of new customers to the firm. To win against industry competition and capture market share, companies cannot operate in an environment of half-hearted advertising spending. Nielsen Advertising Information Services (2013) indicated that Indonesian media spending reached Rp 51. 2 trillion in the first half of 2013. This showed a 25% increase in the national media spending in the first half of 2013 compared to the same period in the previous year, and a 130% increase over the same period in 2009.

One effective advertising medium in conveying a message and affecting consumers is television. Nielsen Advertising Information Services (2013) calculated that in the first half of 2013, television media advertising contributed approximately 68 % of total ad spend. Kotler and Keller (2012: 670) state that the television advertising has a significant advantage in that it has a broad range that combines image, sound, and motion to stimulate the senses and heighten attention. Television advertising has grown from just display images and communication about the product. It now relies on a wider range of

appeal to attract attention. According to Belch and Belch (2009: 283), advertising now contains a kind of fascination that includes informational/rational appeal, but also emotional appeal expressed in fear, humor, or sex.

A significant appeal often used by advertisers is sexual. 'Sex sells' is a trusted philosophy used by several marketers in the pursuit of marketing their products. Sexual appeal advertising is thus one application of the philosophy of "sex sells". The assumption is that consumers are motivated by advertising using sexual and provocative imagery. Furthermore, some marketers will blend sexual appeal with other elements of Belch and Belch's (2009) analysis with often subtle blends of humor or fear. Sexual appeal advertising seeks to attract the attention of consumers and strengthen brand associations. Advertising seeks to attract consumer attention and ultimately influence buying behavior. Buying intention can measure the likelihood of a consumer to buy a product. The higher the consumer interest in a product, the higher will be the consumer desire to buy that product.

In 1983, 15% of advertisements used sex as a selling point. That number increased to 27% in 2003. Out of 18 categories of products, the most frequent use of sexual imagery in advertising was in health and hygiene products at 38%, beauty 36%, drugs and medicines 29%, clothing 27%, travel 23%, and entertainment 21% (Reichert, *businessnewsdaily.com* : 2012). One company that extensively uses sexual appeal in advertising is PT. Unilever Indonesia Tbk (Unilever). In particular, and for the purposes of this research, Unilever uses sexual appeal advertising for the promotion of its AXE range of products.

AXE is a male grooming product first launched in 1983 in France. The AXE brand has now become one of the leaders of male grooming products in more than 60 countries. In Indonesia AXE occupies market leadership winning Indonesia's Favorite Youth Brand 2013 in the perfume/ body spray/ body mist (male) product category. AXE advertisements regularly attract attention. AXE has won the Cannes Lions Advertising Awards more than ten times. One of the series of Indonesian AXE advertisements that have attracted the most attention is the series, "Heaven on Earth". This series follows the AXE message promoted by bikini-clad women in our countries that using AXE products prompts sexual attraction. The series of Indonesian advertisements illustrate that by using AXE products men can captivate an angel to fall from heaven.

The main advertisement begins with a scene whereby a young Indonesian man applies AXE products before going to bed. After falling asleep, the man is woken by a beautiful female winged-angel seductively pulling back his bed sheet and lying next to him. Further angels appear that playfully engage with the man and each other. The angels massage the man's head and shoulders, mix drinks for him and entice him with a soapy and alluring sponge-wash. The advertisement ends with a display of AXE products and a message printed across the screen that states that AXE products have a sexy fragrance.

By using the AXE "Heaven on Earth" series of advertisements, this study seeks to determine the effect of sexual advertising on Indonesian consumers.

### Literature Review

According to Kotler and Keller (2012: 478), advertisements are any paid form of non-personal presentations and promotion of ideas, goods, or services by an identified sponsor. Advertisements have the capacity to reach consumers who are geographically dispersed (Kotler and Keller, 2012: 490). Advertising can build image in the long term for a product or trigger quick sales. Certain forms of advertising, such as TV advertising, require large budgets, while other forms of advertising such as newspapers do not. The mere presence of an advertisement can have an effect on sales. Consumers trust brands extensively advertised. Television is generally recognized as the most powerful advertising medium and reaches a broad spectrum of consumers with low cost per unit exposure. TV advertisement properly designed and implemented can be a powerful marketing tool that can increase brand equity and positively impact on sales and profits.

The appeal of advertising and execution typically rely on one another, so that a certain appeal can be exercised through a variety of ways and can be applied to a particular execution in a wide range of appeal advertisements (Belch and Belch, 2009: 283). Belch and Belch (2009: 283) classify the types of advertising appeal as informational/rational appeal; and emotional appeal which also includes the appeals of fear, humor and sex. Sexual advertising appeal can be described as sexuality in the form of nudity, sexual imagery and innuendo used as an advertising tool for a wide range of products.

---

Formally sexual appeal advertising was defined as mediated message (i. e. in commercial TV ads and magazine ads) containing sexual information with the goal of persuasive selling of branded goods. Sexual information itself is content with sexual meaning that is considered as the source (Reichert, 2002: 243).

Lin (1998: 467-468) reveals that the advertising power of sexual attraction consists of three dimensions, namely the physical characteristics, sexually oriented conduct, and the model's sex appeal.

1. Physical Characteristics: the characteristics or elements such as approximate age, physical shape and the clothing revealed by the model;
2. Sexually Oriented Conduct: behavior consisting of three elements, namely physical innuendo, verbal innuendo and physical contact;
3. The Model's Sex Appeal: The sexual attractiveness of the model him/herself, consisting of three elements, namely physical attractiveness, sexiness and sexual objects involved.

In addition to creating an emotional connection with consumers through sexual appeal advertising, marketers seek the onset of behavioral responses. These responses are sought in behavior that ultimately leads to the purchase of advertised products. The ultimate goal then of advertising is to influence consumers to buy the advertised product and increase company sales.

Schiffman, Kanuk, & Wisenbilit (2010: 497) researched the purchase intention, or the desire/intention of consumers to buy a particular product. Buying intention can be measured by the likelihood of a consumer to buy the product. The higher the consumer interest in the purchase, the higher will be the consumer desire to buy that product. In consumer behavior, buying intention is very often associated with a conative component. Kotler, Armstrong, Harker, and Brennan (2009: 475) through the AIDA models describe the stages through which consumers ultimately determine the attitude of a product.

### Research Hypothesis

Based on the empirical and theoretical review, a research hypothesis of this study is: there is a significant effect of the variable Sexual Advertising Appeal on consumers' intention to buy AXE products.

### Method

The scale used in this study was an ordinal five-point Likert scale with a one shot or cross-sectional method. Usable 120 questionnaires were used. The primary data collection was achieved by distributing questionnaires to the respondents through an online survey. Before completing the questionnaire, respondents were asked to watch via You Tube the AXE television commercial "Heaven on Earth". The link to the ads were given. The study consisted of two variables, namely one independent variable and one dependent variable. The independent variable (X), is sexual advertising appeal consists of three sub variables: Physical Characteristics (X1), Sexually - Oriented Conduct (X2), Model's Sex Appeal (X3). The Dependent variable (Y), i. e. buying intention consists of four sub variables: Attention (Y1), Interest (Y2), Desire (Y3) and Action (Y4).

### Results and Discussion

The results show that the variable of the advertising's sexual appeal has a very strong result with an average index of 4.24 (see Table 1.)

**Table 1. Advertising's Sexual Appeal Scores**

Dimension	Indicator	Index	Category
Physical Characteristics	The suitability of the age of the models for the advertisement	4. 25	Very suitable
	The interest in physical shape of the models	4. 43	Very interested
	Appropriate clothing revealment	3. 97	Appropriate
Sexually-Oriented Conduct	Sexuality of physical activity	4. 29	Very sexy
	Sexuality of voice and textual expression	3. 99	Sexy
	Sexuality of physical contact	4. 09	Sexy
Model's Sex Appeal	Physical beauty of models	4. 41	Very beautiful
	Sexiness of models	4. 49	Very sexy
	Status as a sex object	4. 28	Strongly agree
<b>Total</b>		38. 2	
<b>Average Index</b>		4. 24	Very Good

Source: data used for this research

The results summary indicates some diversity of sexual advertising appeal for each indicator. The highest score from the indicators of 4. 49 was obtained from the *sexiness of the models* indicator that formed part of the model's sex appeal dimension. This dimension also had a very high score for the two other indicators, namely the physical beauty of the model and their status as sex objects. Therefore it can be concluded that the higher the sexual attractiveness of the models, the higher will be the potential to attract the attention of the targeted audience.

The lowest score obtained of 3. 97 was from the *clothing revealment* indicator. Whilst a score of 3. 97 is still relatively high, it also indicates that that the audience exhibited a tendency to oppose clothing that was too blatant or overt. Therefore, in Indonesia some evidence can be given that if female models within advertisements have too revealing clothing, then the advertisement may not be able to perform the intended function of creating positive desires, preferences, beliefs and purchase intention for the advertised product or service.

The study result may further indicate that Indonesians still hold their eastern culture tightly. That is, that there is still some behavior that is considered too inappropriate to be seen. Perhaps understandably the way Indonesians dress is still heavily influenced by Muslim culture, where women are required to wear modest clothing.

Table 2. indicates the summary of scores for each indicator variable that make up *purchase intention*. Overall, *purchase intention* is seen to be quite high with an average index of 3. 275.

**Table 2. Purchase Intention Score**

Dimension	Indicators	Index	Category
Attention	Interested in the way information is given	3. 81	Interested
	Believe in the benefit of the product	3. 22	Quite believe
Interest	Interested to buy product	3. 44	Interested
Desire	Willingness to try the product	3. 41	Willing

Action	Tend to buy the product	3.07	Tend to
	Sure to buy the product	2.7	Quite sure
<b>Total</b>		19.65	
<b>Mean</b>		3.28	Quite good

Source: data used for this research

The *purchase intention* scores indicate some diversity in each indicator. The highest score obtained was 3.81 from the indicator *interested in the way information is given*. This score could indicate the strong advertising power of sexual attraction. The *Attention* dimension is further supported by a relatively strong score for *belief in the benefit of the product*.

The lowest score obtained from indicators was *sure to purchase the product* (2.7). This is understandable as strong interest will not always directly equate with exactly the same equally strong intention to buy. There could also be the possibility that the audience feels that an alternative to AXE products may exist.

Table 3. Coefficient of Determination

#### Model Summary

Model	R	R Square	Adjusted R Square	Std. Error of the Estimate
1	.386 <sup>a</sup>	.149	.140	3.63613

a. Predictors: (Constant), *sexual appeal advertising*

From statistical calculations in table 3 it can be seen that the correlation coefficient (R) between the variables of *sexual advertising appeal* and the *purchase interest* is 0.386. The positive correlation indicates that the relationship is unidirectional, whereby the higher the sexual appeal of advertising; the higher will be the buying intention. According to Taylor (2010: 37) a value of 0.386 (within the range interval 0.36 - 0.67) indicates that there is a strong relationship between *sexual appeal advertising* (X) and *buying intention* (Y)

Results further indicate that the coefficient of determination (R<sup>2</sup>) was 14.9%. This indicates that the variable of *sexual advertising appeal* contributes 14.9% to *buying intention*. The remaining 85.1% is influenced by other factors not included in the model, which may include product quality, price, consumer lifestyle, etc.

Table 1. 4. Regression results

Model		Unstandardized Coefficients		Standardized Coefficients	t	Sig.
		B	Std. Error	Beta		
1	(Constant)	9.668	3.158		3.061	.003
	TX	.305	.074	.386	4.139	.000

a. Dependent Variable: Purchase

Intention

Table 1. 4 indicates a beta coefficient of 0. 386. This shows that there is a positive relationship between *sexual appeal advertising* (X) and *buying intention* (Y).

It can also be seen that: -

The t stat was 4. 139

df = 98 and  $\alpha = 0. 05$  level of significance level of the test is two-way:

Table: -1. 984467 and 1. 984467 t stat: 4. 139. From the calculation, it can be seen that  $4. 139 > 1. 98$  or  $t \text{ stat} > t \text{ table}$ . So it can therefore be concluded that hypothesis H1 is supported. That is, there is a significant effect of the variable *Sexual Advertising Appeal on consumers' intention to buy AXE products*.

### Conclusions and Future Research

The consumer response to AXE's products through the "Heaven on Earth" advertising commercial is very strong. This is indicated by the average index of 4. 24. Male Indonesian consumers in the age of 15-24 responded very positively to AXE products' sexual appeal in advertising measured via physical characteristics, sexually oriented behavior, and sexually attractive female models. This points out that Unilever succeeded in forming a powerful advertising message through sexual attraction that evoked an emotional response in the form of attention.

The potential for consumers to buy the product after seeing an AXE advertisement from the series "Heaven on Earth" is quite strong. This is shown by the average index achieved of 3. 28. Consumers responded well to paying attention and learning the value of the product. Respondents indicated a willingness and desire to try and buy the product. However, respondents were not ascertain to purchase or use the product.

Sexual advertising conducted by Unilever indicate a significant positive influence on consumer buying intention of AXE products, with a t value:  $4139 > t \text{ table}$ : 1. 98. The study resulted in the regression equation  $Y = 9. 668 + 0. 386 X$ , where each increase in sexual advertising appeal (X) should correlate to buying intention (Y) increasing by 0386. Sexual advertising appeal influenced buying intention by 14. 9%. The remaining 85. 1% can be understood as the influence of other factors that are not incorporated into the model.

Of the three dimensions of sexual appeal advertising (Physical Characteristics, Sexually-Oriented Conduct and the models' sexual appeal), it can be seen that the *models' sexual attraction* is the most powerful in Indonesian advertising. In pursuing a path of sexual appeal in advertising, advertisers must therefore be highly selective in choosing advertising models that can represent and evoke sexual attraction. In order to achieve this, advertisers can conduct a sample survey of potential target-profiled customers to ensure that the model is selected according to the preferences of consumers. This will help to minimize an unfavorable image of the brand and the products offered. The selected model should not only have high sex appeal, but also a good reputation so as to improve the image of the brand and the products offered.

The survey results through the *clothing revealment* indicator show that respondents are sensitive to the appropriateness of clothing. Therefore, Indonesian companies need to establish clear boundaries of acceptable aspects of nudity so that these dimensions do not attract negative attention from consumers who could easily form negative associations and reactions to the brand and the products offered. Sexual attraction only explains a small portion of the commercial appeal of advertising. To maximize the advertising power of sexual attraction, companies must be able to create advertisements that are not only attractive, but also convincing and able to convey to customers the value of the products offered. Furthermore, companies may be able to support the advertising power of sexual attraction by conducting integrated marketing communication such as the bundling promotions to encourage consumers to buy.

It is suggested that future researchers could conduct advanced research related to sexual appeal advertising effect models and consumers buying intention. Researchers could also develop this study by using other respondents such as females and those from other age groups. Furthermore, sexual advertising appeal in the print and radio mediums could be explored.



---

## References

- Aaker, David. , Day V. Kumar, & S. George. *Marketing Research*. New York: John Wiley & Sons.
- Belch, George E. , and Michael A. Belch. 2009. *Advertising and Promotion: An Integrated Marketing Communication Perspective, 8<sup>th</sup> Edition*. San Diego: McGraw-Hill
- Bello, D. C. , M. J. Etzel, & R. E. Pits. 1983. *The Communication Effects of Controversial Sexual Content in Television Programs and Commercials*. *Journal of Advertising*, 3 (12), 32-42.
- BPS Kota Bandung. 2012. *Penduduk Kota Bandung Menurut Kelompok Umur Tahun 2012*. Accessed on 2 Januari 2014, from <http://bandungkota.bps.go.id/subyek/penduduk>
- Dewan Periklanan Indonesia. 2007. *Etika Pariwara Indonesia: Tata Krama dan Tata Cara Periklanan Indonesia*. Jakarta: Dewan Periklanan Indonesia.
- Effendy, Onong Uchjana. 2002. *Ilmu Komunikasi, Teori, dan Praktek*. Bandung: Remaja Rosda Karya.
- Ferdinand, Augusty. 2002. *Pengembangan Minat Beli Merek Ekstensi*. Semarang: Badan Penerbit Universitas Diponegoro.
- Hasan, Iqbal. 2006. *Analisis Data Penelitian Dengan Statistik*. Jakarta: Bumi Aksara.
- Hoffman, Griffin, & Simpson. 2005. *Marketing Principles & Best Practices, 3ed International Student Edition*. Mason Ohio United States: Thomson South Western.
- Kaplan, M. Robert and Dennis P. Saccuzo. *Psychological Testing Principles, Application and Issues*. Pacific Grove: Brooks/Cole Publishing Company.
- Kinrear, Thomas C. and James R. Taylor. 1995. *Riset Pemasaran: Pendekatan Terpadu, Terjemahan Edisi Ketiga*. Jakarta: Erlangga
- Kotler, Philip, and Kevin Keller. 2012. *Marketing Management, 14th edition Pearson International Edition*. New Jersey: Prentice.
- Kotler, Philip, Gary M. Armstrong, Michael Harker, & Ross Brennan. 2009. *Marketing: an Introduction, 9<sup>th</sup> Edition*. Prentice Hall.
- Kurniawan, Sigit. 2012. *Strategi Axe Sudah Tepat*. Accessed on 27 Desember 2013, from <http://www.the-marketeers.com/archives/strategi-axe-sudah-tepat-sasaran.html#>. UsA5VdIW1mx
- LaTour, Michael S. , & Tony L. Henthorne. 1994. *Ethical Judgements of Sexual Appeals in print Advertising*. *Journal of Advertising*, Volume 23, Number 3, 81-90.
- Lin, Carolyn A. 1998. *Uses of Sex Appeals in Prime-Time Television Commercials*. *Sex Roles*, 38, 5/6, 461-475.
- Liu, F. , H. Cheng, & J. Li. 2009. *Consumer Responses to Sex Appeal Advertising: A Cross-cultural Study*. *International Marketing Review*, 26, 501-520.
- Maholtra, N. K. 2010. *Marketing Research: An Applied Orientation 6<sup>th</sup> Edition*. New Jersey: Prentice Hall.
- Morisson, Alexander. 2007. *Periklanan Komunikasi Pemasaran Terpadu*. Jakarta: Ramdina Prakarsa.
- Mulvey, Jeanette. 2012. *Why Sex Sells... More Than Ever*. Accessed on 27 Desember 2013, from <http://www.businessnewsdaily.com/2649-sex-sells-more.html>
- Rhenald, Kasali. 2007. *Manajemen Periklanan Konsep dan Aplikasi di Indonesia*. Jakarta: PAU-Ekonomi.
- Reichert, Tom. 2002. *Sex in Advertising Research: A Review of Content, Effects, and Functions of Sexual Information in Consumer Advertising*. *Annual Review of Sex Research*, 13, 241-273.

- 
- Reichert, T. , S. E. Heckler, & S. Jackson. 2001. *The Effects of Sexual Social Marketing Appeals on Cognitive Processing and Persuasion*. Journal of Advertising, 30 (1), 13-27.
- Riduwan, Achmad dan Engkos Kuncoro. 2008. *Cara Menggunakan dan Memaknai Analisis Jalur (Path Analysis)*. Bandung: Alfabeta.
- Schiffman, L. G. , L. L. Kanuk, & J. Wisenblit. 2010. *Consumer Behavior, 10<sup>th</sup> Edition ed.* New Jersey: Prentice Hall.
- Sherman, Claire, & Pascale Quester. 2005. *The Influence of Product/Nudity Congruence on Advertising Effectiveness*. Journal of Promotion Management, Vol. 11 (2/3), 61-89.
- Subagyo, Ahmad. 2010. *Marketing In Business, Studi Kasus UMK & LKM, Edisi Pertama*. Jakarta: Mitra Wacana Media.
- Sugiaro, Catur and Virginie De Barnier. 2013. *Sexually Appealing Ads Effectiveness on Indonesian Customers*. European Journal of Business and Management, 5, 9, 125-135.
- Sugiyono. 2010. *Metode Penelitian Kuantitatif Kualitatif dan RnD*. Bandung: Alfabeta.
- Suliyanto. 2006. *Metode Riset Bisnis*. Yogyakarta: Andi Publishing.
- Taylor, Richard. 2010. *Interpretation of the Correlation Coefficient: A Basic Review*, International Journal of Diagnostic Medical.
- Till, Brian D. & Michael Busler. 2000. *The Match-Up Hypothesis: Physical Attractiveness, Expertise, and the Role of Fit on Brand Attitude, Purchase Intent, and Brand Beliefs*. Journal of Advertising, 29, 3, 1-13.
- Umar, H. 2009. *Metode Penelitian untuk Skripsi dan Tesis Bisnis*. Jakarta: Rajawali Pers.
- Visetbhakdi, Arpavadee. 2011. *The Effects of Sex Appeal Advertising on Thai Consumers' Emotional and Behavioral Responses*. The AU Journal of Management, Volume 9, Number 1, 1-12.
- <http://www.unilever.com/brands-in-action/detail/Axe/292063/accessed 3011024>

---

## Environmental Injustice in Pakistan: Impacts of Upstream Dams on Indus Delta and its Inhabitants

**Abdul Hadi**

Ph. D Student. Ankara University, Faculty of Letteres,  
Department of Sociology, Sihhiye, 06110, Ankara, Turkey.

Corresponding author. Tel. : +90 5074164720.

hadijanwar@gmail.com

### Abstract

*The aim of this study is to focus on the adverse impacts of upstream dams on Indus delta and its inhabitants. The large dams and barrages, besides their global economic significance, have become the focus of strong discussion on account of their frequently severe social and environmental impacts. These negative impacts do not impinge on all people but people who are poor powerless and belong to marginalized ethnic minorities. Since the inception of Pakistan, Punjabi a dominant ethnic group in Pakistan controls armed forces and key political institution and make all decision without considering the interests of Sindh. The construction of dams raises serious environmental justice concerns, with economic benefits for upper riparian Punjab and social and environmental costs for Sindh. The construction activities on Indus River were accomplished largely without getting consensus from Sindh violating the agreement between Sindh and Punjab. Excessive water diversion by Punjab has resulted in the economic, social and ecological problems in Sindh. Deltaic communities of Sindh who draw their livelihood directly from communal access to land, water, forests, coastal mangroves, and other ecosystems are being the hardest hit by the construction of large dams. Sindhi people, especially deltaic people are subjected to environmental injustice due to their subordinate status in Pakistan.*

**Keywords:** Internal-colonialism, Environmental Injustice, Impacts of Dams, Indus Delta, Sindh.

### 1. Introduction

The greatest edifice of human ingenuity large dams are used as powerful symbols of modernization, national prestige, and of human supremacy over nature (McCullay, 2001). The most prominent purpose of building large dams is the Generation of hydropower. Other basic purposes of large dams include the seasonal or annual storage of water for human consumption, agrarian and industrial production and for the reduction of flood peaks. Besides their global economic significance, large dams have become the focus of strong discussion on account of their frequently severe social and environmental impacts. These negative impacts do not impinge on all people but people who are poor powerless and belong to marginalized ethnic minorities.

Patrick McCully (2001) argues that the domination of rivers clearly indicates the link between the control of nature and the control of people. Since the creation of Pakistan, Many large dams, barrages and canals are built in Pakistan. Sindh's civil society organizations and politicians of all dispensation are in concurrence that large dams and barrages in Pakistan are built to give dominant ethnic group Punjabi the ability to direct water for their own benefits, depriving the Sindh and in particular the deltaic people of Sindh. Thus, Sindhis are subjected to environmental injustice.

### 2. Historical background

Pakistan is not one country composed of only one Nation but is a conglomeration of socio-cultural different nationalities. The 'ethnic minorities' that basically comprise the smaller nations of Pakistan never supported the creation of Pakistan. But British imperialists decided to divide up India for strategic reasons and purposely set out to create a new state called Pakistan against the wishes of Sindh and other minority ethnic groups. The Pakistani state was created by putting together ethnic groups that had never before been united in the same polity before British. Sindhi, Baluch and Pashtuns

resisted Punjabi invasions for centuries. After the construction of Pakistan, Sindhi, Baluch, and Pashtuns feel that they are trapped in a political set up which is run by dominant province Punjab since Punjab controls armed forces and key political institutions (Harrison, 2009). Historically Sindh remain a sovereign country. Since the creation of Pakistan, Sindhi lost their political autonomy which has eventually threatened their distinct culture and language (UNPO, 2012).

Sindh is also deprived of its due share of Indus waters, due to the construction of large dams, and barrages and canals located in and benefitting the Punjab where the political power centers of the military and state also reside (Rahman, 2009). The genesis of the water dispute historically lies between the British annexed states of Sindh and Punjab, much before they became provinces of Pakistan. It all started when British colonialist rewarded agriculture lands to the Punjabi soldiers and officers due to their loyal services to British masters in suppressing the indigenous rebellion movement against the British colonialists in 1857 (Rahman, 2009, Talpur, 2001). In order to irrigate these lands, British colonialists started massive water projects in Sindh without the consent of lower riparian Sindh whose rights were perceived to be already established under international and subcontinental laws, which safeguard the rights of the lower riparian. In spite of their obvious imperialist bias in favor of the Punjab, the British did not view the grave injustice being done to Sindh like a spectator. When Punjab planned to build new projects on Indus river system, Sindh objected that the projects has potential threats to its agriculture and economy. Both provinces were under colonial administration with some indigenous representation and each side negotiated robustly defending its rights. These negotiation documents contain the agreement that was reached finally in 1945 known as the Sindh-Punjab Water Agreement which granted 75% share of waters to Sindh and 25% to Punjab, as Punjab had access to four other rivers (Rahman, 2009).

The blatant violation of this accord started since the creation of Pakistan. Before the creation of Pakistan, there was only one barrage built on the river Indus. Since the creation of Pakistan, all of the 19 barrages, 43 canal systems, three major storage dams and 12 link canals that have been built in Pakistan after partition, have been in Punjab. The share of Sindh from Indus water has been drastically reduced. This has brought great benefits to the agriculture of Punjab at the expense of Sindh. In contrast to 94 million-acre feet of water that reached Indus delta before partition. Now the Indus River dries up hundreds of miles before reaching the delta and 1.2 million Sindhi farmers and fishermen have lost their livelihood and out-migrated since the partition. The construction activities on Indus River were accomplished largely without getting consensus from Sindh violating the agreement between Sindh and Punjab. All of these construction activities other than the two additional barrages in Sindh mostly benefits Punjab. Most of the land brought under cultivation due to barrages in Sindh was distributed among non-Sindhis (Memon, 2002).

Excessive water diversion by Punjab has resulted in the economic, social and ecological problems in Sindh. Sindh is being deprived of its rightful share and getting less share (IUCN, 2007). Sindhis feel that Punjab is robbing its water and denying of its historic rights to Indus water endorsed by Punjab itself in 1945 agreement. The crisis arising from shortage has compelled many political groups to protest as they claim that their rightful share of water is being stolen (Rinaudo, 2001). Thus, since the creation of Pakistan, Sindhi people are subjected to environmental injustice. Environmental injustice takes place when some people or communities bear environmental burdens disproportionately, like those of hazardous waste dumps, or has unequal access to environmental good, like clean air, or has less opportunity to participate in environmental decision-making process (Shrader-Frechette, 2002).

The literature that addresses issues of environmental injustice indicate that race tends to be more important than class in most cases, although both are sometimes significant determinants of environmental injustice. However, In this case, Environmental injustice with deltaic communities in Pakistan can be explained with the help of "Internal Colonialism Theoretical" Perspective.

### 3. The Internal Colonialism Theoretical Model

Colonialism is a process in which more powerful nations exploit other nations and show their economic and sociopolitical dominancy over them. In contrast, internal colonialism is a condition in which both the dominant group and subordinate groups co-exist as natives of the same society (Adeola, 2000). All around the world, the minorities and indigenous communities pay the prices of social and environmental harm.

Historically Sindh remains a sovereign country. Since the creation of Pakistan, Sindhi lost their political autonomy which has eventually threatened their distinct culture and language (UNPO, 2012). The prevalence of internal colonialism has

been noted in this study wherein a dominant ethnic group Punjabi in control of a government systematically exploits resources of Sindhi people. This is an environmental injustice with Sindhis resulting from their subordinate and colonial status in Pakistan. Thus, Sindhis are facing environmental injustice due to prevalence of internal-colonialism.

Punjabi being a dominant ethnic group abuses its absolute power to exploit the resources of periphery (Sindh) to develop the core (Punjab). Deltaic people who draw their livelihood directly from communal access to land, water, forests, coastal mangroves, and other ecosystems are being the hardest hit by the construction of large dams. The construction of dams raises serious environmental justice concerns, with economic benefits for upper riparian Punjab and social and environmental costs for Sindh. Most of the Sindhi people depend upon the water of Indus River. Shortage of it not only create environmental problem but also social problems. Construction of dams in Punjab have made their fertile lands barren, and disrupted their family and social life.

#### **4. Impacts of upstream dams on Indus Delta and its inhabitants**

##### **(a) Impacts on Delta and its Ecosystem**

Indus Delta which is located in Sindh is totally dependent upon water of Indus River. It covers a large part of the province of Sindh, occupying about 3 million hectares. It is about 240 km in length along the axis of the river and 220 km at its widest. The formation of Indus delta has become due to high Indus river discharge. However, Excessive water diversion at upstream has drastically reduced the quantity of water and silt from reaching the Indus Delta. Consequently, Indus delta is being rapidly transgressed (Memon, 2005).

The ecosystem of delta area is in under stress from the encroachment of sea and increasing salinity. Sea water has intruded in many areas along the coast pressurizing the livelihood of fishing and farming communities. According to WWF Pakistan Director Ghulam Akber (2009) 2 million acres of fertile delta have been eroded due to inadequate release of water in the Indus downstream of Kotri (The News, 2009).

When Indus River discharge into the sea, it sustains the mangrove forests. Mangroves are essential component of the coastal system. The World Bank (2005) reports that mangroves of Indus Delta were spread in 345,000 hectares, but now these mangroves cover only 160,000 to 200,000 hectares. Even the remaining area is being degraded. Mangroves have been decimated mainly by low Indus flows below Kotri, according to the Environmental Concerns Report (GoP Study II 2005) of the international group set up by the Government of Pakistan. In a detailed study of the Indus delta, Haq (1999) points out that the active delta has shrunk to less than one tenth of its original size (from 2,600 km<sup>2</sup> to 260 km<sup>2</sup>) (Khan, 2005).

##### **(b) Socio-economic impacts on Deltaic region**

Before the construction of upstream dams, Lands of this region were fertile, rice and other crops were cultivated. People used to tender animals, everyone had 50 or 100 animals (livestock). Fish was in abundance. People were prosperous and lived happy life. However, the construction of upstream dams severely impacted the lives of deltaic people. The livelihoods of millions of fisher-folk, of agriculture and of livestock-rearing communities as well as the naturally rich ecosystem of the region has threatened with the degradation of Indus delta (Action Aid Pakistan, 2005). The joint Government of Sindh-World Bank report on socioeconomic conditions in the coastal districts of Badin and Thatta points out that in the past, people of coastal region used to generate income through multiple income sources. Fishing was a main source of livelihood along with crop and livestock farming. The decline in flow forced communities to shift their livelihood to fisheries (WB 2005). For many, fishing has become a livelihood of the last resort, but the yield, too, is decreasing (Ghazanfar, 2009).

### **Impact on Agriculture**

The income generating crops, such as red rice crops, Orchards of banana, papaya and guava are almost destroyed. Government of Sindh Conducted a survey which indicated that just within three districts of this region over 486,000 hectares land were either eroded or lost due to sea intrusion and quarter million people were dislocated. Recently, it is estimated that 567,000 hectares of the land lost to the sea (Memon, 2004). Loss of fertile lands has created economic down turn and forced people to migrate. Hundreds of villages in both Badin and Thatta districts have been migrated to other areas (Kazi, 2004).

### **Fish Depletion**

The depletion of fish is on the increase. The catch of a number of fish species has drastically reduced. There is a considerable decline in Migratory fish species, such as Pallo and Barramundi (SAP, 2001). Pallo accounted for 70% of the total catch in the past. But now it barely constitutes 15 percent of the total catch.

### **Livestock**

In the past, due to its fertility including vast tracts of green pastures, Katcha and mangrove forests, the Delta region of Sindh had remained ideal for livestock grazing. The Delta agriculture community had been rearing large numbers of livestock, including cattle, camels, goats, sheep, etc. As such, the Deltaic region was famous for its milk, butter oil or ghee and other associated products of livestock. With the decline in fresh water flow due to upstream dams, fertility of this area included grasses and pastures withered and lost. With the shortage of pastures and grasses, livestock become physically weak and were attacked by various diseases. The majority of the livestock died while the villagers, due to growing poverty, sold the remaining livestock (Memon, 2005).

Ensuing Poverty: The impact of resource degradation in Sindh and the Deltaic region has emerged in the form of poverty. The people of rural Sindh and especially the Indus Delta have been hit hard. Due to the scarcity of water and resulting economic downturn, people are finding it very hard to make the ends meet. Unemployment, poverty, crime rate, and other social problems are all on the rise. Over two thirds of population is under the poverty line. Poverty has harmed the cultural values. For instance, Traditional Sindhi hospitality is on a rapid decline. Economic pressures have engendered psychological problems. Suicide rates are on increase, especially among young and women (Memon, 2004).

### **Forced Migration:**

The decline in Indus flow at delta has resulted in sea intrusion and resource degradation. Both sea intrusion and resource degradation forced people to migrate to other areas of Sindh. It is estimated that 90,000 people have become displaced and 120 villages uprooted (Brohi, 2004).

### **Availability of Water for Drinking:**

The reduction in Indus River flows has created a crisis-like situation with the shortage of drinking water. The drinking water supplies have dwindled and degraded in quality. Thus local people are forced to drink brackish and contaminated water which has caused an increase of 200 percent of water borne diseases jut in the last few decades . The report of National Conservation Strategy (NCS) indicates that about 40% deaths occur due to water-borne diseases. Worse sufferers are the women, children and aged-people (Zaigham, 2006).

### **Conclusion**

Since the creation of Pakistan, the dominant ethnic group Punjabi violating the Sindh-Punjab water accord signed by both parties in 1945 constructed many large dams and barrages on Indus River. Being a demographically and politically

dominant, Punjabi makes all decision without taking account of the interests of Sindh. These dams, barrages and canals are located in and benefitting the Punjab. The construction of dams raises serious environmental justice concerns, with economic benefits for upper riparian Punjab and social and environmental costs for Sindh. Excessive water diversion by Punjab has resulted in the economic, social and ecological problems in Sindh. Deltaic people of Sindh who draw their livelihood directly from communal access to land, water, forests, coastal mangroves, and other ecosystems are being the hardest hit by water diversion at upstream. Diseases are prevalent due to unhygienic drinking water. Everyone is struggling for their survival and make their ends meet. Thousand acres of agriculture land has so far been devoured by sea and thousands of people have forcedly migrated to other cities. Sindhi people, especially deltaic people are subjected to environmental injustice. This is all due to their colonial and periphery status in Pakistan.

### References:

- Action Aid Pakistan. (2005). Degradation of Indus Delta: lives of 2 million poor are at risk," Action Aid report, <http://www.actionaidpakistan.org>, February 8.
- Adeola, F. O. (2000). Cross-National Environmental Injustice and Human Rights Issues, a Review of Evidence in the Developing World.
- Brohi, S. (2004). Socio-economic Impact of Reduced Indus Flow on Indus Delta and Its Local Communities, National Seminar, University Of Sindh, Jamshoro, January15 – 16.
- Ghazanfar, M. (2009). The Environmental Case of Sindh. *Lahore Journal of Policy Studies* 3 (1).
- GoP. (2005). Study of water escapages downstream of the Kotri Barrage to address environmental concerns (StudyII). Final main report. Kotri Barrage Study-II Consultants group, Islamabad: Government of Pakistan, Ministry of Water and Power and Federal Flood Commission of Pakistan.
- Harrison, S. S. (2009). Pakistan: The State of the Union. Special Report. Center for International Policy.
- IUCN. (2007). Sindh Strategy for Sustainable Development, Planning and Development department Government of Pakistan. <http://cmsdata.iucn.org/downloads/sssd.pdf>.
- Kazi, A. M. (2004). Overview of Water Resources in Pakistan, National Seminar, University of Sindh, Jamshoro, Pakistan, January15 – 16, 2004.
- Khan, S. R. (2005). Environmental and other contested aspects of the Kalabagh dam project. *SDPI Research and News Bulletin* 12 (5).
- Magsi, H., And Atif, S. (2012). Water Management, Impacts and Conflicts: Case of Indus water distribution in Sindh, Pakistan.
- McCully Patrick, (2001): *Silenced Rivers-The ecology and politics of large dams: Enlarged and Updated edition*, Zed Books Ltd.
- Memon, A. A. (2002). An overview of the history and impacts of the water issue in Pakistan. In: *Proceedings of the International Conference on Sindh, the water issue and the future of Pakistan*. The Wolrd Sindhi Institute. . Washigton DC.
- Memon, A. A. (2004). Evaluation of Impacts on the Lower Indus River Basin Due to Upstream Water Storage and Diversion. *WWER Congress*, Salt Lake City, Utah, June 27 – July 1, p 9.
- Memon, A. A. (2005). Devastation of the Indus River Delta. *Proceedings, World Water & Environmental Resources Congress 2005*, American Society of Civil Engineers, Environmental and Water Resources Institute, Anchorage, Alaska. (Note – Expanded version).
- Rahman, H. (2009). Ethnic Tensions and the Future of Pakistan: The Case of Sindh. In S. S. Harrison (2009). *Pakistan: The State of the Union. Special Report*. Center for International Policy (67-73).
- Rinaudo, J. D. (2001). Corruption and water allocation: the case of public irrigation in Pakistan, *Water Policy*, 4: 405-422.

- 
- SAP. (2001). Water Crisis in Pakistan (News Clippings, Reports, Articles)," A South Asia Partnership Report, May 4, 2001.
- Shrader-Frechette. (2002). Environmental Justice: Creating Equality, reclaiming Democracy. Oxford University Press.
- Somarajah. (1981). Internal Colonialism and Humanitarian Intervention M. , Ga. , J. , Int'l & Comp. , L. [Vol. 11: 1.
- Talpur, M. A. M. (2001). Water shortage in Sindh: Causes and consequences, Sangat (SANA) Spring 2001, 17 (1): 9 -1.
- The News. (2009). Deforestation, water pollution major threat to Sindh. The News (English newspaper). <http://www.thenews.com.pk/TodaysPrintDetail.aspx?ID=181703&Cat=4&dt=6/7/2009>.
- UNPO. (2012). Report of The General Secretary to the 11th UNPO General Assembly May 2010 – November 2012. UNPO International Secretariat. Unrepresented Nations and Peoples Organization.
- UNPO. (2013). UNPO Celebrates World Environment Day. Unrepresented Nations and Peoples Organization.
- WB. (2005). Socio-economic study and proposal for livelihood improvement: Badin and Thatta Districts, Sindh, Pakistan. Agriculture and Rural Sector unit South Asia Region. Washington: World Bank.
- Zaigham, N. A. (2006). Impact Of Controlled Environmental Flow & Earthquake Activities On Indus Delta Causes Irreversible Poverty.



---

## How Many Children Would You Like to Have? Exploring Romanian Fertility Decline

**Iulian Stănescu**

Affiliation: Research Institute for Quality of Life, Romanian Academy

stanescu.iccv@gmail.com

### Abstract

*Since the early 1990s, Romania has experienced population decline. Moreover, the pace of this decline is similar with other Central and Eastern European countries, former members of the Soviet bloc or the former Yugoslavia, and sharper than in Western Europe. Besides migration, of more concern over the long term is the drop in the birth rate. According to data from two nation-wide surveys from late autumn 2014, a plurality of adult Romanians (44%) has fewer children that they would like to have. A similar share of the population (42%) has as many children as they would like to have, while a small minority (14%) has more children than they would like to have. Furthermore, in the less than 36 years of age category, a majority of 63% declared that they have fewer children that they would like to. This paper explores the issue of low births at individual level to see if there is a relationship between several variables (age, gender, urban/rural residence, ethnic group, subjective well-being, education, marital status, use of Internet) and whether and individual has fewer, as many or more children than he or she would like to. The analysis was performed on a consolidated dataset of 2,131 adults, obtained by merging the datasets of two nationwide surveys, which used the same questions and the same sampling techniques.*

**Keywords:** Romania, population decline, births, fertility, children.

### Introduction

For a generation, Europe has experienced demographic decline. The phenomenon raises major economic, social and political issues for the future. While in Western Europe immigration damped the effect of low fertility, most of the countries in Central and Eastern Europe saw their population fall due to a combination of higher mortality, low fertility and emigration.

This paper looks into the fertility decline experienced by Romania in the past quarter century. Following a brief overview of the main theories and explanations for demographic decline, we analyze macro level data covering fertility and population indicators trends in Europe for the past 50 years. In the second stage, we use individual level, nationwide, representative sample data to compare the desired and actual number of children for adult Romanians. Furthermore, we explore the relationship between several variables (age, gender, urban/rural residence, ethnic group, subjective well-being, education, marital status, use of Internet) and whether and individual has fewer, as many or more children than he or she would like to.

### Method

The methodology relies on secondary analysis. At macro level, we use population data regarding fertility rates and other population indicators for European countries covering the interval 1960-2012. At individual level, we use sample data from a consolidated dataset of 2,131 adults, obtained by merging the datasets of two nationwide surveys, representative for the adult population of Romania. The data was collected during October 3-8, 2014 (sample size 1,212) and October 21-24, 2014 (sample size 919) by the CCSCC polling company for the Liberal Institute "Brătianu", using the same questions and sample techniques. The surveys were based on a probabilistic tri-stadial stratified sample using the computer assisted telephone survey technique. Phone numbers included both mobile and fixed telephony. The margin of error for the consolidated dataset is +/- 2.12 at the 95 per cent level of confidence and +/- 2.77 at the 99 per cent level of confidence. All the variables included in the individual-level analysis are categorical (marital status, age category, level of education, Internet usage, subjective wellbeing, gender). The choice of statistical tests derives from the available variables and their type. The available variables cover social-demographical and economic variables, but do not include cultural or ideational variables. Another missing variable is ethnicity. Although it is present in the dataset, a common issue in Romanian surveys

is the under-representation of the Roma/Gipsy population. The reason is that some Roma/Gipsy respondents self-report themselves as Romanians. As a result, the Roma/Gipsy group covers 0.8 per cent of the sample, compared to 3.3 per cent (620,000) at the 2012 census and an estimate of 1.5 million by the Research Institute for Quality of Life in 2002 (Zamfir & Preda, 2002, 13). No variable in the dataset covers religious affiliation or behaviour. This situation prevents the use of factor analysis or loglinear analysis, which would result in an incomplete model. We therefore opted for the use of the chi-square test for each of the abovementioned variables and a categorical variable regarding the desired versus actual number of children.

### Theories and explanations for demographic decline

In the second quarter of the 20<sup>th</sup> century, demographers noticed a change in the pattern of population growth across nations and continents. Warren Thompson (1929) introduced a classification of countries in three major types by rate of population growth, according to different combinations of birth and death rates. The first group of countries included the most developed countries of that era, Western Europe and the United States. These countries experienced a rapid decrease in population growth due to low mortality and low fertility. Moreover, the pace of the decline in fertility was so fast that it allowed for a potential population decline in the future. In the second group of countries, both death rates and birth rates were in decline, but mortality was much lower and had fallen much earlier than fertility. Although declining, birth rates were, in relative terms, still high and allowed for a rapid population growth, with rates far higher than compared with the first group. Thompson estimated that declining birth rates would eventually move these countries, mostly from Eastern and Southern Europe, into the first group. Finally, the great majority (70-75%) of the world's population at that time, living in less developed countries and the colonies, featured high fertility and high mortality.

Close to the end of the Second World War, Notenstein (1944) presented the classic formulation of the demographic transition theory. In its most basic form, it states that all societies experience a transition from a pre-modern pattern of high mortality and high fertility to a post-modern one with low mortality and low fertility. At the core of this transition are socio-economic factors, especially modernity's twin processes of industrialisation and urbanisation that led to changes in the way of life, values and norms. According to Notenstein (1953, 13-31), "The new ideal of the small family arose typically in the urban industrial society. It is impossible to be precise about the various causal factors, but apparently many were important. (...) As a consequence, the cost of child-rearing grew and the possibilities for economic contributions by children declined. Falling death rates at once increased the size of the family to be supported and lowered the inducements to have many births."

The demographic transition theory has been debated, the main points of critique being its accuracy and the issue of its development as a generalization. Overall, the historical record of the transition's occurrence represents its strong point. On the other hand, the weak spot comes from the less than successful forecasts regarding the threshold and pace of fertility decline (Kirk, 1996, 365). As noted by Coale (1973, 65), the problem accurate forecasting arises because there are more conditions involved in triggering the decline of marital fertility, summed up as the following:

- (1) Fertility must be within the calculus of conscious choice;
- (2) Reduced fertility must be (perceived) as advantageous;
- (3) Effective techniques of fertility reduction must be available.

The causes and conditions of demographic transition are highly relevant for understanding the decline in fertility. For the sake of space, this section presents a very brief overview of this issue.

The *decline in mortality* is part of the demographic transition and always precedes any decline in fertility. While providing an explanation for the decline in fertility has proven to be a difficult endeavour, the reduction of mortality could be more easily tracked to three processes in Western Europe in the 19<sup>th</sup> and 20<sup>th</sup> centuries. First, the development of the modern state fostered public order, investment in sanitation (the Sanitary Movement), famine relief, education and medicine. Secondly, a revolution in medicine around the turn from the 19<sup>th</sup> to the 20<sup>th</sup> century allowed the development of medicine and treatments that resulted in a sharp decrease in child mortality, later infant mortality and longer life expectancy. Third, this was followed in the mid-20<sup>th</sup> century by another wave of innovation in medicine with the discovery of antibiotics and the establishment of universal healthcare systems and/or national vaccination programs. The cumulative effect was the all but

eradication of infectious diseases, and their replacement as the main source of deaths by chronic diseases (Schofield, et al. , 1991). In itself, mortality decline is seen more as a condition that the main cause of fertility decline. Research on a direct, close relationship failed to deliver conclusive results, and may even be impossible. Psychological effects are cited as possible results. With longer life spans, humans feel more in control of their own destiny and environment. The worldview of industrial and post-industrial individuals is less fatalistic and passive (Kirk, 1996, 368-369).

Economists have weighed in the debate about the factors of fertility decline, with an approach founded in micro-economics and the view of individuals as rational actors (Becker, 1981). The main idea is that in the modern world the *economics of childbearing make it economically disadvantageous to have children*. A more sophisticated framework put forward by economist Richard Easterlin (1975) featured three determinants: 'demand', the desired number of children, 'supply', the cultural elements related to natural fertility, and 'cost', monetary, time and psychological constraints of having children.

John Calwell's (1976) *wealth flow theory of fertility decline* provides an interesting explanation for the change from a pre-industrial high fertility regime to a post-industrial low fertility one. Developed from anthropological field studies in Africa, the theory asserts that in pre-modern societies, wealth in the family flows from the children or the younger members to the parents or elders. To this effect, children are akin to insurance for old age and a source of free labour for the household. In modern families, the reverse takes place. Parents invest substantially in the education and future of their offspring. In both cases, there is economically rational behaviour.

A stronger emphasis on *cultural and ideational causes* was put forward by Ron Lestaeaghe (1983). Differences in fertility across societies and the pace of fertility decline are linked to the degree of secularism, materialism and individualism. Changes in the ideological sphere bring about different needs, including the consumption of luxury goods, less intense religious beliefs and practices, and a strong orientation towards self-fulfilment.

*The role of the state* is another factor. In addition to the support for public order, public sanitation and the provision of health care, abovementioned, the modern welfare state has enforced laws that prevent the use of child labour and exploitation. In addition, a traditional goals of labour policy include increased the female labour market participation and equal pay. Compulsory education and a broader education policy aiming for more years in the education system have increased the cost of having children in the household. Poverty reduction through education also results in decreased fertility (Sen, 2000). Highly relevant is population policy. In the third quarter of the 20<sup>th</sup> century, some developing countries aimed to reduce population growth through family planning. China is the best known example. Another less known example is Iran, which after a pro population growth policy in the 1980s has successfully changed course and reduced fertility through an extensive family planning policy (Brown, 2008, 136-140).

The *diffusion theory* offers an explanation for why the change in the reproductive behaviour of individuals in a given society is much faster than changes in the economic sphere. Mass communication makes the spread of ideas and practices incomparably faster than in pre-modern societies, and the same is applies to fertility control and family planning. Diffusion also covers the spread of contraceptive technology. The effect of the pill in fertility decline in the 1960s and 1970s in Western Europe is a prime example (Murphy, 1993). The social nature of individual decisions is stressed by Carlson (1966, 165): "Birth control behaviour is contagious and the fertility behaviour of a population is not the simple aggregate of isolated individual decisions, but the end product of complex social interactions." Fertility decline is the result of social networking that spreads and legitimizes birth control. The decision is at the same time a group decision and an individual decision (Cleland & Wilson, 1987). However, the development of a whole theory on the role diffusion is debated. McNichol (1992, 406) sees it as "a description in search of theory".

After reviewing the search for causality in the demographic transition, Dudley Kirk (1996, 379-380) put forward four conclusions:

- 1) Mortality decline is a prime factor, which destabilized the old pattern of high mortality and high fertility;
- 2) All causes are closely linked and part of the wider process of modernization; each cause emphasizes different element of this process;
- 3) Once started in Western Europe Fertility, transition spread rapidly and independent of the socio-economic level;

- 4) The causal factors could be groups in economic and social, on one hand, and cultural and ideational, on the other hand; American tend to favour the former, Europeans the latter; socio-economic factors receive perhaps undeserved dominance due to being easier to measure and hence regarded as more 'scientific'.

Oppenheim Mason (1997) identified four errors in the thinking about demographic transition that stand in the way of a better thinking on the issues:

- 1) The assumption that transitions in all societies have the same cause: in fact, there are different combinations of causes and conditions;
- 2) Ignoring mortality decline as a precondition for fertility decline;
- 3) The assumption that the regulation of fertility is different in pre-transitional and post-transitional societies;
- 4) Focusing on a decadal time scale.

### Population decline in Europe and Romania

In this section we will explore the issue of population decline in Romania at macro level, in a regional and European context. For the past 50 years the world fertility rate has experienced a major decline from slightly above 5 to just below 2.5 (see Figure 1). The most developed areas in the world during this period, North America and Europe, featured the lowest fertility rate. Within Europe, the dynamic, but not the pace, of fertility decline has followed the initial forecast made by Notenstein (1944), with the rest of the continent following the trend set by the more developed states in Western Europe. Indeed, fertility rates in the rest of Europe - the former Soviet Union and the former members of the Soviet bloc - were higher than in Western Europe, while mirroring the overall trend of decline. The states of the former Yugoslavia had lower fertility rates than Western Europe up to the early 1970s, but higher afterwards. The gap between Western Europe and the rest of the continent is also observable if we look at the last year with a total fertility rate above the replacement level (see table 1). The maximum gap is of 16 years, between Western Europe (1976) and the former Soviet Union (1992).

This pattern was changed in the 1990s. After the collapse of Communism, first with the disintegration of the Soviet bloc during the revolutionary year of 1989, followed by the dissolution of the Soviet Union in 1991, and the breakup of Yugoslavia in the 1990s, Central and Eastern Europe experienced a population decline, caused by higher mortality (compared to the previous decades), lower fertility, and emigration. Overall, between 1989 and 2012, these 21 states lost 5.5 percent of their population total. Moreover, two thirds experienced population decline. Out of these, nine states saw their population reduced by 11 percent or more. With a 14 percent decline in total population, Romania ranks 15<sup>th</sup> out of 21, and second, behind Bulgaria, out of former Soviet bloc members (see table 2). The causes of this sharp decline, highly unusual in times of peace and without the occurrence of a pandemic, has been debated by social scientist. The shock therapy strategy of the transition from a Soviet-style economy to a capitalist one in the early 1990s, which featured mass privatisation, high unemployment, lower living standards, explosion of poverty and increased social and economic inequality, was identified as a crucial determinant in adult mortality dynamics in post-communist countries in a seminal article authored by Stuckler, King and McKee (2009). In the case of Romania, the transition strategy was critically analyzed by Zamfir (2004).

In the 21<sup>st</sup> century, policy makers in Europe face the problem of population decline and the associated long term effects on the economy and society. Population or family support policy – with the goal to raise fertility rates - is a topic of public and academic debate (Gauthier, 2007; Heran, 2013; Luci-Greulich & Thevenon, 2013). Recent studies focused on Europe's demographic challenge (Grant, et al., 2004; Hoorens, et al., 2011) found that while immigration in the EU would not prevent aging and its consequences, governments could slow down, but not reverse the population decline by policies aimed at raising fertility. However, such policies have limitations: they are not universal, but context-dependent, take time and deliver change slowly, and no single policy could be recommended.

2015 marks a quarter of a century of demographic decline in Romania. 1989 was the last year with population growth, but also the last year with a fertility rate above replacement level. The dynamic of Romania's birth rate features several peculiarities. In the early 1960s, the country experienced a serious reduction of births. In fact, in 1964 the fertility rate dropped below the replacement level. In 1966, the authorities at the time, at the personal initiative of the Communist Party

general secretary, took the decision to limit abortion to serious medical situations. As a result, fertility jumped to 3.6 the following year (see figure 1). Over a 20-year period, this surge of fertility would result in a population increase of almost 40% (from 16.6 million in the 1960s to 23.2 million in 1989), putting a severe strain on the dependency rate, education, healthcare, and social services. However, the population adapted and controlled fertility through different means, in spite of the official government pro-natalist policy (Zamfir, 1999). In spite of the official ban on abortion and the unavailability of the pill, fertility was controlled, gradually returning close to the average of the Soviet bloc. After the 1989 Revolution, the difficult socio-economic context of the transition and the abandonment of the pro-natalist policies of the old regime (abortion was liberalized) led to a severe drop in the number of births, with a fertility rate of around 1.3-1.4, well below the replacement level. The main features of fertility in Romania in the subsequent decades since 1990 are: an increase of the age of the mother at the first birth, from the 20-24 category to the 25-29 age group, which also replaced the former as the one with the highest share of births; persistent high prevalence of abortion compared to other European countries, despite a decline from the high water mark of 1990 (close to 1,000,000 registered abortions); pre-modern pattern of extra marital births (young women from deprived areas, with low or no education); a breakdown in occupational status of the mother into two major groups: employed, 48 per cent, and not employed, 44 per cent (Rotariu, 2010; Rotariu & Voineagu, 2012). In the 2010s, Romanian fertility rates are below, but close to the European average, which is still far below the replacement level (see figure 2). Moreover, it is very similar to other European countries in the same region and/or with a similar level of development. The complexity of Europe's fertility problem is observable in the low correlation between GDP/per capita and the fertility rate (0.2 for 2012 data, see figure 2). At the present fertility rate, and with no changes due to increased emigration, Romania's population is forecasted to decrease by 1 million inhabitants per decade, reaching 17 million in the 2030s and less than 15 million by 2050 (Ghețău, 2012). In comparison, the population total stood at 23.2 million in 1989.

### Data and variables

The available dataset allowed for an analysis of the difference between two continuous variables regarding the desired and the actual number of children. The key question regarding the former was drafted as follows: "how many children would you like to have or would have liked to have?" (The past tense phrasing took into consideration the part of the population no longer able to have children due to biological reasons). The overall result is interesting, considering the low fertility rate in Romania (see table 3). 27.6 per cent of respondents declared that they have no children, but only 8.7 per cent stated they would not like to have children. While the share of respondents that would like to have a single child is quasi similar, the share of respondents that would like to have three or more children is higher than the share of respondents that declared they have three or more children. In addition, the mean for the former variable is 2.05, while for the latter is 1.46.

By using the difference between these two continuous variables we computed another variable that accounts for the difference between the desired and actual number of children. In a further stage, we recoded this variable into another, categorical variable. A frequency analysis of this variable showed that a plurality of adult Romanians in the sample (44 per cent) have fewer children than they would like to have; a similar share (42 per cent) have as many children as they would like to have, while a small minority (14 per cent) have more children than they would like to have. The relationship between this variable and the following socio-demographical variables was analysed using the chi-square test:

- gender
- age category, with four age groups: 18-35, 36-49, 50-64, 65 and older
- urban/rural residence
- subjective wellbeing, used as alternative for income (estimation of household total income compared to needs), with the following categories: we have everything we need, without great effort; we are able to buy more expansive goods, but with some effort; we have enough for decent living, but we can not afford more expansive goods; we have enough for basic needs, we do not have enough even for basic needs
- education: primary school or no education, general school (lower secondary education), vocational school (upper secondary), high school, post-secondary and non-tertiary school/college, higher education
- marital status: unmarried, married, divorced, separated, widow

- Internet usage: yes or no.

## Results

There was a significant association between whether a person has fewer, more or as many children as he or she would like to have and the following (in descending value of the test statistic): marital status ( $\chi^2(8) = 228.44$ ,  $p < 0.001$ ), age category ( $\chi^2(6) = 150.29$ ,  $p < 0.001$ ), education ( $\chi^2(10) = 82.75$ ,  $p < 0.001$ ), Internet usage ( $\chi^2(2) = 51.15$ ,  $p < 0.001$ ), urban/rural residence ( $\chi^2(2) = 33.40$ ,  $p < 0.001$ ), and subjective wellbeing ( $\chi^2(8) = 25.68$ ,  $p < 0.001$ ). There was no significant association with gender (see table 4).

The results for marital status are in line with the marital predominance of Romanian fertility. 73.9 per cent of unmarried respondents (adjusted standardized 13.8) have fewer children than they would like to. The other way around, 26.7 per cent of widows and widowers respondents have more children than they would like to (adjusted standardized 4.8).

The age category features similarities with marital status. In the 35 years of age and less group, 62.3 per cent have fewer children than they would like to (adjusted standardized 11.3). At the opposite end, 19.9 per cent of those aged 65 and older say they have more children than they would like to (adjusted standardized 3.5).

In terms of education, a majority of respondents with higher education (57.1 per cent, adjusted standardized 6.3) declared they have fewer children than they would like to. In comparison, 24.4 per cent of respondents graduates of general school (adjusted standardized 4.8) and 21.4 per cent of respondents in the primary school or with no education category stated they have more children they would like to.

Almost two thirds (64.8 per cent, adjusted standardized 5.5) of Internet users (57.6 per cent of the sample) have fewer children than they would like to, while 20.2 per cent of people that do not use the Internet have more children than they would like to.

## Discussion

Since 1990, for over a quarter of a century, Romania has experienced population decline. The trend is similar with other countries from Central and Eastern Europe. In a quarter of a century, Romania lost 14 per cent of its population. The country ranks second to Bulgaria among former Soviet bloc members and 15<sup>th</sup> out of 21 states that are former members of the Soviet Union, Soviet bloc or Yugoslavia. After shadowing the declining fertility trend of Western Europe, but with higher fertility rates up to the 1990s, Central and Eastern European countries entered a new stage in their demographic transition, with fertility rates below Western Europe. In addition to higher mortality, Central and Eastern European countries, including Romania, face population decline or stagnation due to emigration to Western Europe.

This paper also explored the issue of low births in Romania at individual level by using sample data. The analysis had its limitations in the fact that too few variables were available, especially covering cultural and ideational factors. The main findings point to a potential for increased fertility. In other words, there is a low birth rate in Romania despite Romanians wanting more children. The mean of desired children in the sample is 2.05, compared to a mean of 1.46 for actual children. A plurality of adult respondents in the sample (44 per cent) has fewer children that they would like to have. A comparable share (42 per cent) has as many children as they would like to have. Finally, a small minority (14 per cent) has more children than they would like to have. Moreover, the majority of those with fewer children than they would like to have are from the aged up to 35, unmarried, more urbane, with higher subjective wellbeing, Internet using strata. Further research, especially qualitative, should provide a wider understanding of the reasons underpinning these results.

## Tables and figures

Table 1 Critical years for the total fertility rate in Central and Eastern Europe

last year above replacement level	year with lowest TFR
-----------------------------------	----------------------

EU-15	1976	1998
former Yugoslavia	1984	2006
AC 8+1	1988	2002
Romania	1989	2001
former Soviet Union	1992	2001

Source: The World Bank

Note: AC 8+1 includes 8 former Soviet bloc and former Yugoslavia states that acceded European Union in 2004, plus Bulgaria

Table 2 Population dynamics in European states, former members of the Soviet bloc, Soviet Union or Yugoslavia

Former part of...	Country	1989 population	2012 population	Difference
		Millions	Millions	Percentage
USSR	Azerbaijan	7.2	9.4	31.5
YUG	FYR Macedonia	2.0	2.1	4.5
YUG	Slovenia	2.0	2.1	3.5
Soviet bloc	Slovakia	5.3	5.4	2.3
Soviet bloc	Czech Rep.	10.3	10.5	1.8
YUG	Montenegro	0.6	0.6	1.1
Soviet bloc	Poland	38.1	38.5	1.1
USSR	Russia	148.3	143.5	-3.2
Soviet bloc	Hungary	10.4	9.9	-4.6
YUG	Serbia	7.6	7.2	-5.5
USSR	Georgia	4.8	4.5	-6.7
USSR	Belarus	10.2	9.5	-7.1
YUG	Croatia	4.8	4.3	-11.1
USSR	Ukraine	51.9	45.5	-12.3
Soviet bloc	Romania	23.2	20.0	-14.0
YUG	Bosnia-H.	4.5	3.8	-15.5
USSR	Estonia	1.6	1.3	-15.6
USSR	Armenia	3.5	3.0	-16.0
Soviet bloc	Bulgaria	8.7	7.3	-16.6
USSR	Lithuania	3.7	3.0	-20.1
USSR	Latvia	2.7	2.0	-24.4

---

Total	351.3	333.2	-5.2
-------	-------	-------	------

---

Source: The World Bank

Table 3 Breakdown of the sample by the respondent's desired and actual number of children

Number of children	Desired	Actual
0	8.7 %	27.6 %
1	24.8 %	25.4 %
2	37.2 %	29.2 %
3	16.9 %	12.4 %
4 and more	12.4 %	5.4 %
Mean	2.05	1.46
Median	2.0	1.0
Std. Deviation	1.26	1.28

Source: survey database

Table 4 Chi-Square tests output

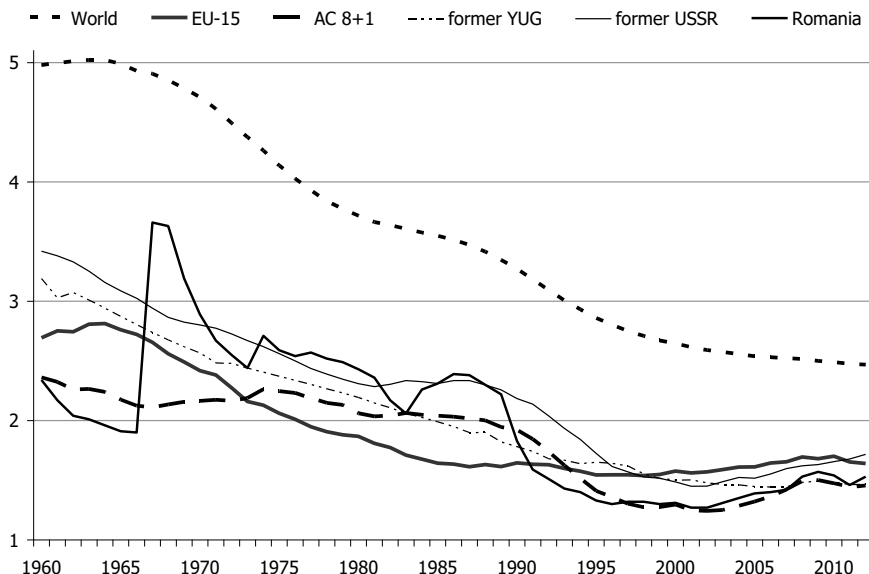
Variable	N of valid cases	df	Pearson Chi-Square	Asymp. Sig. (2-sided)
Marital status	2,063	8	228.440	0.000*
Age	2,063	6	150.286	0.000*
Education	2,062	10	82.747	0.000*
Internet usage	2,049	2	51.145	0.000*
Urban/rural residence	2,063	2	33.396	0.000*
Subjective wellbeing	2,025	8	25.682	0.001*
Gender	2,063	2	3.981	0.137

Source: survey database

\* p &lt; 0.001

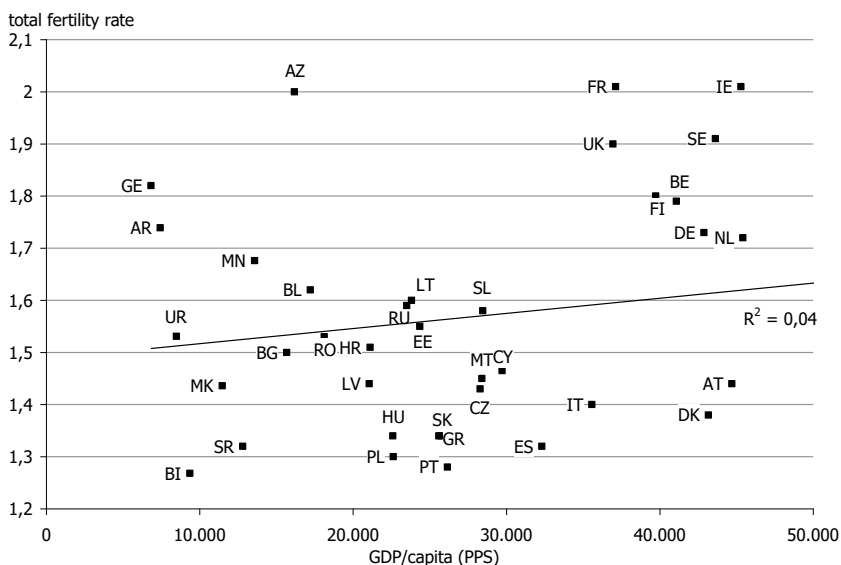


Figure 1 Total Fertility Rate post 1960



Source: The World Bank

Figure 2 Total Fertility Rate and GDP per capita (PPS) in Europe in 2012



Source: The World Bank

## Acknowledgement

This paper is made and published under the aegis of the Research Institute for Quality of Life, Romanian Academy, as a part of a research programme co-funded by the European Union within the Operational Sectorial Programme for Human Resources Development through the project for Pluri and interdisciplinary in doctoral and post-doctoral programmes. Project Code: POSDRU/159/1. 5/S/141086.

## References

- Becker, G. S. (1981). *A Treatise on the Family*. Cambridge, Mass. : Harvad Unviersity Press.
- Brown, L. R. (2008). *Plan B 3. 0 Mobilizing to save civilization*. New York: WW Norton & Company.
- Caldwell, J. C. (1976). Towards a restatement of demographic theory. *Population and Development Review*, 2, 321-366.
- Carlson, G. (1966). The decline of fertility. Innovation or adjustment process? *Population Studies*, 20 (2), 147-174.
- Cleland, J. , & Wilson, C. (1987). Demand theories of the fertility transition. An iconoclastic view. *Population Studies*, 41 (1), 5-30.
- Coale, A. J. (1973). *The demographic transition reconsidered*. In Proceedings of the International Population Conference 1973 Liege, 53-73.
- Easterlin, R. (1975). An Economic Framework for Fertility Analysis. *Studies in Family Planning*, 6, 54-63.
- Gauthier, A. H. (2007). The impact of family policies on fertility in industrialized countries: a review of the literature. *Population Research and Policy Review*, 26 (3), 323-346.
- Ghețău, V. (2012). *Drama noastră demografică. Populația României la recensământul din octombrie 2011*. București: Compania.
- Grant, J. , et al. (2004). *Low Fertility and Population Ageing. Causes, Consequences and Policy Options*: RAND Corporation.
- Heran, F. (2013). *Fertility and family-support policies: what can we learn from the European experience?* In 27th International Population Conference, Busan, South Korea.
- Hoorens, S. , et al. (2011). *Low fertility in Europe. Is there still reason to worry?* : RAND Europe.
- Kirk, D. (1996). Demographic Transition Theory. *Population Studies*, 50, 361-387.
- Lesthaeghe, R. (1983). A century of demographic and cultural change in Western Europe. An exploration of underlying dimensions. *Population and Development Review*, 9 (3), 411-435.
- Luci-Greulich, A. , & Thevenon, O. (2013). The impact of family policy packages on fertility trends in developed countries. *European Journal of Population*, 29 (4), 387-416.
- McNichol, G. (1992). The agenda of population studies. A commentary and a complain. *Population and Development Review*, 18 (3), 399-420.
- Murphy, M. (1993). The contraceptive pill and female employment as factors in fertility change in Britain 1963–80: a challenge to the conventional view. *Population Studies*, 47 (2), 221-243.
- Notenstein, F. W. (1953). *Economic problems of population change*. In Proceedings of the Eighth International Conference of Agricultural Economists, New York, 13-31.
- Notenstein, F. W. , et al. (1944). *The future population of Europe and the Soviet Union : population projections 1940-1970*. Geneva: League of Nations.
- Oppenheim Mason, K. (1997). Explaining fertility transitions. *Demography*, 34 (4), 443-454.

- 
- Rotariu, T. (2010). *Studii demografice*. Iași: Polirom.
- Rotariu, T. , & Voineagu, V. (Eds. ). (2012). *Inerție și schimbare: dimensiuni sociale ale tranziției în România*. Iași: Polirom.
- Schofield, R. , et al. (Eds. ). (1991). *The Decline of Mortality in Europe*. Oxford: Clarendon Press.
- Sen, A. (2000). *Development as Freedom*. New York: Anchor.
- Stuckler, D. , et al. (2009). Mass privatisation and the post-communist mortality crisis: a cross-national analysis. *Lancet* (373), 399-407.
- Thompson, W. S. (1929). Population. *American Journal of Sociology*, 34 (6), 959-975.
- Zamfir, C. (1999). Tranziția demografică și problemele sociale asociate. In C. Zamfir (Ed. ), *Politici sociale în România: 1990-1998* (pp. 149-181). București: Expert.
- Zamfir, C. (2004). *O analiză critică a tranziției. Ce va fi "după"?* Iași: Polirom.
- Zamfir, C. , & Preda, M. (2002). *Romii în România*. Bucharest: Expert.

---

## Fiscal Policies Applied in Kosovo and Their Impact in the Competitiveness in Kosovar Businesses

Skender Hasani, PhD Cand.

University College "Vision for education", Ahmet Kariqi,  
7000 Ferizaj – Kosovo, skender\_hasani@yahoo. Com

<sup>1</sup> e-mail: skender\_hasani@yahoo.com

### Abstract

*Fiscal policies play an important role in the economic development of a country. Finding more favourable fiscal policies allows not only raising the necessary monetary funds for the functioning of the state but also the distribution of budget revenues in different development projects which will have an important role in economic development and the development of conditions for operation of private businesses as a condition for a sustainable economical growth. While in the after war period in 1999 the goal of fiscal policy has been meeting the immediate needs for normal functioning of life in Kosovo today fiscal policies should be in place for a sustainable economic development which will be a guarantee for state operation thus creating a healthy climate not only for businesses but also for our population. Changes in the world and globalization have had an impact in having a strong competition between different economies, including the economies of most developed countries of the world. As all the economies of other countries so the Kosovo economy as a whole and businesses in particular are not immune to this competition but they daily face these competitiveness issues not only form the competition of regional and European countries, but also from businesses from all continents. The Kosovo economy and the one of all countries in transition faced many difficulties which have affected the development of local businesses and the competitiveness of those businesses compared to businesses in the region and beyond. Through this paper we analyzed fiscal policies that are applied in Kosovo from 1999 to 2014 and we measured the impact of these fiscal policies in the overall development of Kosovo businesses. Particular emphasis in this paper was put on the steps to be taken by the government and substantial reforms to be made in order to establish fiscal and commercial facilities which will affect the growth of local businesses, increase their competitiveness and with it the increase of employment and social welfare of the citizens as a strategic goal for Kosovo and its economy.*

**Keywords:** economy, businesses, fiscal policies, competitiveness, reforms

### INTRODUCTION

Fiscal policies are a group of all measures undertaken by the State in respect of income, wealth and accumulation made by natural and legal persons for the purpose of fund raising to finance public expenditures. Therefore, through the use of fiscal instruments such as taxes, public expenditures, and public debts etc. state affects all economic costs such as salaries, employment, economic growth etc. The aim of these measures is for the state to have an impact and regulate the cyclical movements in the economy respectively to affect the growth and development of the economy, to increase domestic production and along with the increase of the employment level.

With adequate fiscal policies undertaken by the state, it could affect the employment level and maintain stability in the economy. Kosovo since 1999 until the declaration of independence in 2008 did not have its own autonomous fiscal policies but they have been applied by the United Nations Mission UNMIK through the so-called UNMIK Pillar II - Regulation which has been responsible for making and implementation of economic and fiscal policies in Kosovo. By analyzing the results of those fiscal policies it is obvious that they were mainly oriented to maintaining financial stability and very little impact on Kosovo's economic growth, increase of domestic production and along with the increase of competitiveness of SOEs with those of the region and beyond.

After the independence in 2008, although Kosovo was supervised for some time in politics it made in terms of economy, Kosovo has independently created its own fiscal policy but not monetary ones, because Kosovo's official currency is Euro and Kosovo can not impact on the increase or decrease of the cash or other steps, as it is widely known that Kosovo is not a part of the euro zone but due to circumstances it had to have European common currency Euro as the official currency.

However the period since 2008 until now even though it was proclaimed that changes were made in fiscal policies compared to those applied by the UNMIK regulation, and that those policies will directly affect the growth of domestic production, growth the competitiveness and profitability of Kosovo businesses, increasing foreign direct investment and the level of employment, and that the multiple effects of these measures would be very large and will enable not only maintaining financial stability and sustainability of Kosovo but will have an effect on employment and consumption as an important element of this economic growth, the effects of these changes did not have a significant impact on economic development.

From 2008 until now there are some changes to tax rates which in one way or another are adapted to those in the region but did not create such fiscal policy which would enable the business community in Kosovo to substantially feel them and which would enable businesses in Kosovo competitive to those from abroad, and which would also make foreign investors feel these changes in order to invest their capital in Kosovo and that investment would have an effect on employment, consumption, growth GDP and why not create and increase revenues for the state budget.

### **PURPOSE AND THE OBJECTIVES OF THE STUDY**

The purpose and objectives of this paper is not only to analyze the rate of economic development of Kosovo, the participation of Kosovo products that are exported to those that are imported, the structure of economic participation but to review and give our contribution to finding better ways to alternation and implementation of such fiscal policies and historical and financial aspects that will affect sustainable economic growth, employment growth, increasing purchasing power of the population which would increase the size of the sensitive effects on economic development.

Economics today on one hand are facing stiff competition from companies abroad, faced with an economy and unfair competition but also significant decrease of the purchasing power of the population. Therefore there is a need for comprehensive analysis of governmental institutions, the business community and civil society in order to find and take radical steps and multidimensional amendments which would help to improve the macroeconomic parameters of Kosovo and the improvement business activity and increasing the competitiveness of Kosovo businesses in comparison with those of other countries.

Kosovo has a low rate of economic growth, which is mainly due to a less favorable environment for business, lack of investment and small financial possibilities and fears of local producers to enter into manufacturing projects, where production carries a higher risk of transfer rate and return on investment for a longer period than those of other sectors of the economy.

The economic growth of 3 percent according to the report of Kosovo Central Bank, as it was assessed during 2014 it is not enough to overcome the many problems with which the Kosovo economy is facing, as many social problems, absorption of new work power entering the labor market every year and which have essential influence on the growth of the purchasing power of citizens because today's economics and household faces shortage of purchasing power which has a chain effects on the overall economy.

Even Kosovo's economic trade balance compared to that of the region and beyond still has a deterioration trend and is extremely unfavorable and due to the policies which have been pursued so far by the government that are oriented more toward coverage of budget needs which still greatly encourages imports than in creating meaningful development policies that would encourage local production and increase the competitiveness of producers and local businesses in their entirety with businesses from other countries.

Therefore even the structure of budget revenues realized so far but also those projected for the future are from the share of revenues from imported goods respectively revenues levied at the border which still remains above 65 percent. These fiscal and developmental policies that have been applied so far in Kosovo have made Kosovo since 2000 until now always to have a large trade deficit and that deficit continues due to these policies, as well as the heavy dependence on imports, the trade deficit in 2012 was 2. 5 billion Euros, in 2013 was 2. 4 billion Euros, and in 2014 was 2. 2 billion Euros. So even though we have a small decrease in trade these last three years this deficit is still high and requires a serious commitment of the governmental relevant decision taking institutions so that this disproportion be mitigated considerably. This can be done only by undertaking of substantial fiscal and developmental reforms that will affect the growth of domestic production and reduce the demand for imported goods.

Fiscal sector was characterized by a slight decrease of revenues and budget expenditures increased during the first half of 2014. Kosovo Budget recorded primary deficit of 22. 0 million Euros to June 2014 (7. 6 million deficit in the same period of 2013 ). General government debt in the reporting period was EUR 554. 4 million or 9. 9 percent of GDP, compared with 9. 1 percent in 2013. Kosovo continues to have the lowest level of general government debt compared with regional countries (58. 1 percent of GDP is the average public debt of countries in the region in 2014). Besides that it has the lowest level of public debt, however during 2014 Kosovo has increased it slower compared to the average of the region. <sup>1</sup>

One of the problems highlighted by the business is overseeing the functioning of the market, respectively, unfair competition, which still has large dimensions. All businesses are facing this problem, regardless of the sector in which they operate.

Export has also a very low turnout and a very unfavorable structure, where nearly half of it is accounted for base metals and participation of exports is still very low in volume which in 2014 had a turnout of 324 million Euros, which is much lower than the imports made in Kosovo.

While in 2013 net exports contributed positively to economic growth, as a result of increased exports and decline in imports, net exports in 2014 estimated that contributed negatively to GDP growth by 0. 1 percentage points. The deterioration of net exports position during 2014 is estimated to have been a consequence of deepening the goods trade deficit of 2. 6 percent. Exports of goods estimated to have recorded nominal growth of 10. 4 percent (6. 5 percent in 2013), while imports of goods 3. 6 percent (annual decline of 2. 3 percent in 2013). Despite increasing exports, much higher level of imports has made net exports of goods to contribute negatively to growth. Regarding trade in services, the nominal value of their exports estimated to have increased to 14. 1 per cent in 2014, while their imports estimated to have increased to 18. 9.

Participation of other items remains low: food and beverages (from 8. 1 in 2005 to 6. 6 percent in 2014), and machinery and mechanical electrical equipment (from 11. 6 percent to 4, 3 percent). There are some minor improvements in the participation of Kosovo in export products such as products of plastics and tires in export which participation has increased from 1. 7 percent in 2013 to 6. 2 percent, and the share of textile products has grown from 1. 1 percent in 2013 to 4. 3 percent in 2014 and have increased participation of plant products from 5. 1 in 2013 to 5. 2 percent in 2014.

Such structure of export testifies the low competitive ability of domestic producers, as well as the lack of capital for investment in technology in order to increase the quality, then the acquisition of seductive forms of packaging, as well as more aggressive marketing.

Kosovo faces huge commercial difference and small coverage with import. In the table below the coverage of imports by exports over the years is presented.

Table 1: Kosovo exports and imports with all the countries (000 €)

Year	Export	Import	Difference	Coverage percentage
2004	56,567	1,063,347	-1,006,780	5. 3
2005	56,283	1,157,492	-101,209	4. 9
2006	110,774	1,305,879	-1,195,105	8. 5
2007	165,112	1,576,186	-1,411,074	10. 5
2008	198,463	1,928,236	-1,770,213	10. 3
2009	165,328	1,935,541	-1,770,213	8. 5

<sup>1</sup> Kosovo Central Bank, Report on macroeconomic developments, number 2, February 2015

2010	295,957	2,157,725	-1,861,769	13.7
2011	319,165	2,492,348	-2,173,184	12.8
2012	276,100	2,507,609	-2,231,509	11.0
2013	293,842	2,449,064	-2,155,222	12.0
2014	324,554	2,538,232	-2,213,678	12.78

Kosovo	Macedonia	Serbia
<p><b>Goods exempt from customs</b></p> <ul style="list-style-type: none"> <li>- Exports</li> <li>- Diplomatic or consular missions and their staff</li> <li>- Import of goods which are for the official use of UN or any of its organ</li> <li>- UNMIK, specialized agencies, KNKK, KFOR, EULEX</li> <li>- Import of goods financed by grants awarded by governments, governmental agencies, governmental and non-governmental organizations to assist programs and humanitarian projects such as those for Kosovo's reconstruction.</li> <li>- Imports of specific goods for which Kosovo Government decides that should be used for humanitarian purposes.</li> <li>- Zero custom tax for a wide spectrum of raw material and equipments</li> <li>- Removal of double taxation with Albania</li> </ul>	<ul style="list-style-type: none"> <li>- Incentives in areas of industrial technological development</li> <li>- Corporate profit tax -0 (outside the area 10 %);</li> <li>- Personal Income Tax 0 (outside the area – 10 %);</li> <li>- VAT - 0 (outside area 18 %)</li> <li>- Excise 0 (outside the area 5-62 %);</li> <li>- Processing materials and equipment are exempt from customs duty</li> </ul>	<ul style="list-style-type: none"> <li>- For big projects: grants up to 20% of investments;</li> <li>- For projects of wide standards: 4,000-20,000 euro for a new working place;</li> <li>- For big investments: 10 years break from Corporate income tax;</li> <li>- For investments: tax credit on corporate income to 40% of investments in real estate;</li> <li>- Removal of double taxation;</li> <li>- Exemptions from tax charges on wages and social security;</li> <li>- Annual income tax deduction up to 50% of taxable income</li> </ul>

Source: Kosovo Agency of Statistics, Ekonomik Statistics, Januar 2015; page 9

Situated in Eastern Europe, Kosovo's economy has become part of the economic integration of the region, providing market expansion opportunities. Aim in itself already is to increase its competitiveness by increasing export capacity to reduce the trade deficit that Kosovo currently has.

As an important location for business development, Kosovo offers a range of comparative priorities as young population and somewhat qualified, natural resources, favorable climatic conditions, new infrastructure, fiscal policy with the lowest taxes in the region tax, geographic position with access to the regional market CEFTA and in the on of the European Union.

The government does not open new jobs but creates the possibility for their opening in this case the unemployment rate will decrease and the reduction of poverty and other chain effects on local businesses as well. Channeling budget in several

major infrastructures projects but not in projects that would affect the growth of productive capacity of Kosovo businesses and the reduction of the dependence of imported products are some of the elements which should have been and should be urgently taken by relevant state institutions. Kosovo has a high potential for agricultural production and for building processing capacities of these products which would enable not only the reduction of the import of these products but also the employment growth of a large number of people including those in the agricultural and industrial capacity.

But if you compare measures and facilities that the Kosovo government has done we could say that Kosovo has significantly stalled in proposing initiatives and creating various facilities for manufacturing businesses especially for those businesses that employ a lot of people, create added value over half in Kosovo and their products are export-oriented. Besides the release of certain imported goods from customs tax - mainly in machinery and less on raw material, no other measure that facilitates doing business has been taken. On the other hand, countries in the region, such as Serbia and Macedonia provide investment incentives, tax holidays, use the parcels whole infrastructure.

So far, some of the steps that have been undertaken by government institutions are:

1. Subsidy of several activities with an emphasis on agriculture;
2. Facilitating and accelerating the procedures for business registration;
3. Facilitation of some customs procedures;
4. The guarantee of deposits to 2000 Euros;
5. Reducing the tax on business income.

But the undertaking of these steps did not have the expected impact because Kosovo manufacturers and Kosovo businesses are still facing numerous difficulties which have played a decisive role that although there have been some actions and reforms of government institutions they still have not played the effect which is intended by the government.

If we analyze only the effects of the reforms outlined above we can conclude that those steps have not been sufficient and have been deficient since we are in a situation where:

1. The level of subsidy for agricultural activities has not created conditions for local products to be competitive against those imported neither in terms of price nor quality.
2. Facilitation of business registration procedures was not followed by other facilities in obtaining other necessary permits to develop the activity for which they have invested their capital.
3. Facilitation of customs procedures has failed to stop the informal economy which developed mainly from import goods since the import export ratio today is 88/12.
4. Although the guaranteed deposits are up to 2000 we still have the highest rates of interest in the region and beyond and it directly affects the difficulty of financing various projects by businesses in Kosovo.
5. Reduction of taxes on corporate income from 20% in 2009 to 10% is not accompanied by the combat of informal economy the rate of which, according to statistics of different institutions of the economy, ranges from 28-33% from the gross general product which for 2013 was EUR 5,800,000. 00 in Kosovo.

## RESEARCH QUESTION - METHODOLOGY OF TREATMENT

The purpose of this paper is to review what actual steps have been undertaken by the state institutions so that the economics in general and businesses in particular to help businesses overcome difficulties of their occasional cases as a result of those streams.



Based on this relevant Kosovar institutions have tended to undertake a number of actual steps that would create a favorable climate for business, to arrange for Kosovar businesses to be equal to the conditions of doing business offered to businesses in other countries, however based on the responses received from a number of Kosovo businesses we can say that the businesses are not satisfied with the steps which were taken by institutions due to the obstacles that arise in their business either because of shortcomings in legislation or due to failure to legislation by the authorities.

With the aim of analyzing these steps which were taken by relevant institutions and analyzing the situation of doing business in Kosovo we have prepared a questionnaire and sent it to a significant number of Kosovar businesses from whom we asked to answer a number of questions which we deemed relevant and which can give a clearer picture of their situation and their perception of the steps taken by the government. Of the total number of over 10,000 businesses registered in Prishtina region and which develop business (information obtained from the Tax Administration of Kosovo) we analyzed the information returned by 100 businesses of different activities 50 in trade and services and 50 in production )that have been answered and their perception on doing business, their difficulties and other elements that accompany their daily activities.

### ANALYSES – INTERPRETATION OF DATA

In order to accomplish this paper we have interviewed 100 businesses in various activities 50 from them in trade and services and 50 in filed of production where we have submitted sever questions to business leaders in which they have responded mainly with Yes or No.

Table with questions and answers by various respondents in trade and services

No.	Research question	Yes	No
1	Do you think that doing business in Kosovo is difficult?	49	1
2	Did you increase turnover from 2008 onwards?	27	23
3	Did you increase employment from 2008 onwards?	15	35
4	Did you increase profit from 2008 onwards?	16	34
5	Do you think that the Government has undertaken sufficient steps to overcome the business difficulties in Kosovo?	4	46
6	Did you benefit from any subsidies or grants from the Government of Kosovo?	13	37
7	Do you think that the conditions of doing business in Kosovo are more favorable compared to other countries in the region?	9	41

8	Do you think that the legal infrastructure is sufficient to protect your investments in Kosovo?	17	33
9	Would you transfer your business activity in the region or abroad if you had the opportunity?	37	13
10	Do you think that the Government should do fiscal political reforms in order to create a more favorable climate for businesses?	46	4

Table with questions and answers by various respondents in production

No.	Research question	Yes	No
1	Do you think that the Government should do fiscal political reforms in order to create a more favorable climate for businesses?	50	0
2	Do you think that the conditions of doing business in Kosovo are more favorable compared to other countries in the region?	4	46
3	Do you think that the Government has undertaken sufficient steps to overcome the business difficulties in Kosovo?	3	47
4	Did you benefit from any subsidies or grants from the Government of Kosovo?	11	39
5	Do you think the producers should be exempt from customs duties on raw materials?	50	0
6	Do you think the producers should be exempt from VAT on raw materials?	50	0
7	Do you think the government should subsidize local producers especially exporters?	50	0
8	Are your products competitive in terms of quality compared to other imported products?	32	18
9	Are your products competitive in terms of price compared to other imported products?	29	21

10	Do you have difficulty in placing your products from unfair competition in goods similar to what you produce?	24	26
----	---	----	----

From the information obtained from the interviews which were conducted with a significant number of businesses we can emphasize that most of them are not satisfied with the conditions that exist for doing business in Kosovo and believe that doing business is very difficult and this does not come as a result of the taxation system in Kosovo because fiscal charges in Kosovo are quite small but this difficulty is caused by other associated elements of business activities such as:

Considerably high scale informal economy which affects an unfair competition compared to businesses that conduct their activities in accordance with applicable rules and legislation in Kosovo.

Lack of an efficient and reliable judiciary in resolving various disputes between businesses;

Unfavorable loan system for businesses;

Provision of subsidies and grants for a sustainable economy based on disciplines that are most needed and not on the basis of parameters which are not properly analyzed.

## CONCLUSION - RECOMMENDATION

From data obtained as from the interviews conducted with a large number of businesses or even obtained from the relevant local and international institutions operating in Kosovo, it can be concluded that the steps which were taken by the relevant state institutions were not sufficient to establish a stable climate of doing business in Kosovo and therefore this situation has had an impact in businesses having significant difficulties and it has led to having businesses, a part of them, cease their activities, another part of them transferring their activities in other countries of the region and a part of them working with various difficulties, which may affect them in the future to have the fate of some businesses that have closed or transferred their capital abroad.

Therefore based on the above we can conclude that it is quite necessary to undertake some substantial reforms with the aim of creating equal conditions, for businesses that develop activities in Kosovo, to those from the region and beyond, those steps are:

1. Exemption from customs duties and VAT for all imported raw materials
2. Subsidizing certain percentage of capital for new investments in infrastructure and machinery in manufacturing depending on the number of workers that the business would employ
3. Tax break for withholding tax, social contributions and profit tax depending on the number of employees the company employs
4. The escalation of VAT for products and exemption from VAT for deficient products
5. Automatic reimbursement of VAT with the aim of introducing instruments in circulation
6. Creating infrastructure conditions not only in the road but power supply, water and other elements which are necessary for the creation of a stability for businesses operating in Kosovo;
7. Use of intellectual capacity and experience from various areas of business;
8. Creating the conditions for foreign direct investment.

## Bibliography:

1. Statistical Office of Kosovo. (2014). Economic Statistics Gross domestic product in the expenditure approach (2008-2013) ', Pristina, Kosovo
2. CBK, Monthly Statistical Buletin, Decembar 2014,Nr. 10, Prishtina, Kosovo
3. CBK, Report of makroekonomik Development,Nr. 2, February 2015, Prishtina, Kosovo
4. MTI,Report of industrial development in Kosovo,January 2014,Prishtina, Kosovo
5. Rea, Privat Sector and potential investments,Mars 2015, Prishtina
6. Statistical Office of Kosovo, Statistics of Forign Trade,January 2015, Prishtina, Kosovo
7. UNDP, Impact of tax regime in four producing sectors, 2014,Prishtina, Kosovo
8. *Thematic Roundtable no. 4. (2012), Trade, industry, customs, tax, internal market, competition, consumer protection and health, Pristina,Kosovo*
9. International Monetary Fond ,(2013) Republic of Kosovo several selected issues, Strategy for cooperation on USAID for the development of the country of Kosovo 2014 -2018,
10. Government of Kosovo, (2011) *Vision and Action Plan for the Economical Development,*
11. USAID. (2012). *Study on the effect of the irregular supply of electricity in Kosovo Businesses,*  
*World Bank, (2012). World Development Indicators*
12. World Bank, (2013). *Doing Business Report*
13. USAID, (2012). *Diagnosis of Growth in Kosovo: Analysis of Barriers*

---

## Student Engagement in Fostering Quality Teaching in Higher Education

**Dražena Gašpar**

*Faculty of Economics - University of Mostar, Matice hrvatske bb,  
[drazena.gaspar@sve-mo.ba](mailto:drazena.gaspar@sve-mo.ba)*

**Mirela Mabić**

*Faculty of Economics - University of Mostar, Matice hrvatske bb,  
[mirela.mabic@sve-mo.ba](mailto:mirela.mabic@sve-mo.ba)*

### Abstract

*Student engagement should be one of the most powerful drivers for improvement of quality teaching in higher education. As students are direct beneficiaries of quality teaching, they are able to provide crucial feedback not only on what works well but also on what they would like to be done differently and how. The paper presents results of research related to students' perception of course Accounting Information Systems (AIS) and way of its implementation at the Faculty of Economic - University of Mostar. At this course lectures include many opportunities for active student engagement through cooperative learning activities (debates, team work, and presentation of project results). The authors developed two questionnaires in order to investigate the students' understanding of AIS course at the beginning and at the end of lectures. At the first class students completed a questionnaire about their expectations from AIS lectures (content, their engagement, learning activities, learning outcomes, assessment) and at the last class they completed another questionnaire about their real experiences related to AIS lectures. Research has been conducted for last two years and it enabled authors to use its results to tailor lectures in accordance with student's expectation and accordingly to improve teaching process.*

**Keywords:** student survey, student evaluation of teaching, teaching quality, student engagement.

### Introduction

Last decades it has become obvious that citizens of an increasingly complex community, country and globalized world need the skills, critically reflective processes and creative approaches in order to cope successfully. Education institutions are urged to prepare students for entry into this competitive environment by equipping them with appropriate skills, knowledge, values and attributes. There is a strong drive to build and create knowledge together with an understanding of working life and reformulate the concept of knowledge in education institutions. Namely, education institutions, especially higher education institutions, are bound to provide quality teaching that leads to learning outcomes and, above all, added value for their students.

In Learning and Teaching, the traditional teacher centred, transmission model of learning adopted by the 'sage on the stage' (McWilliam, 2007; referenced by Martin, 2010) has gradually begun to change to a more facilitative approach to teaching that is learner centred and where the teacher becomes the 'guide on the side'. Barr and Tagg (Barr, Tagg, 1995; referenced by Martin, 2010) see this shift from an 'instructional' to a 'learning' paradigm as changing the role of higher education institutions (HEI) from a 'place of instruction' to a place to 'produce learning'. Given greater democracy in learning, McWilliam (McWilliam, 2007; referenced by Martin, 2010) suggests that the teacher can become the co-creator of new meaning making.

Today's higher education institutions are complex organisations under high pressure from different directions and fostering quality teaching is a daily challenge for them. Although most universities have developed teaching and learning strategies, they still struggle to implement them and effectively assess their impact on the learning experience. It is hard to find

way to match overall learning needs of students with curriculum development and to ensure programmes are relevant for students living in a globalised world.

Quality teaching is a complex issue and it requires the overall commitment of the entire institution:

- *Institution level* - policy development, support for organisation and internal quality assurance systems.
- *Programmes level* - comprising actions to measure and enhance the development, content and delivery of academic programmes.
- *Individual level* - initiatives that help teachers achieve their mission, encouraging teachers to innovate and support improvements to student learning and adopt a learner-oriented approach.

In the framework of international project Tempus CCMLL (Curricula Modernisation and Long Life Learning Centre), University of Mostar developed *Handbook for teaching programme and curricula development*. Handbook consists of two parts. In the first part are explained and described learning outcomes, competence and student oriented teaching. In the second part is presented methodology for development of teaching programme and curricula at University of Mostar. Model of teaching programme development at University Mostar includes following elements (Rezić & Višekruna, 2012):

- Existence of appropriate resources.
- Existence of need for specific teaching programme identified through consultations with internal and external stakeholders (academic staff, students, business, public institutions, non-governmental organizations and so on).
- Well defined profile of teaching programme.
- Defined set of expected learning outcomes expressed as field and generic competences.
- Defined end described academic content (knowledge, understanding and skills) and structure (modules and credits).
- Adequate strategies of teaching, learning and identification of achievement in order to realise expected learning outcomes.
- Adequate system of evaluation and quality assurance, especially focused on coherence of teaching programme and its compatibility with qualifications framework.

The research presented in this paper is result of process of evaluation and quality assurance related to teaching process, especially focused on students' perception of course Accounting Information Systems (AIS) and way of its implementation at the Faculty of Economic - University of Mostar.

### **Student engagement in teaching process**

The field of student engagement encompasses theory, practice and policy. It is huge and varied, with a significant history of publications in academic journals, published syntheses of literature (Trowler 2010; Trowler and Trowler 2010 referenced by Healey et al. , 2014); edited anthologies of case studies and articles (Nygaard et al. 2013; Bryson 2014; Dunne and Owen 2013a; Solomonides, Reid and Petocz 2012; Little 2011 referenced by Healey et al. , 2014); and nationally commissioned studies and reports (Little et al. 2009 referenced by Healey et al. , 2014).

As a concept, "student engagement" is ambiguous and contested (Healey et al. , 2014). Within learning and teaching it can be divided into two broad areas:

- Student engagement as the way in which students invest time and energy in their own learning,
- Ways in which students are involved and empowered by institutions to shape their learning experiences, both inside the classroom and beyond (Kuh et al. , 2007 referenced by Fry et al. , 2015).

Kahu argues that problems in the definition of engagement stem partly from the conflation of the state of engagement, its antecedents, and its consequences (Kahu, 2013 referenced by Fry et al. , 2015). Engagement involves the student, the teacher, the institution and the learning context. It is a "meta-constructor" that brings together various threads of research on student success (Fry et al. , 2015).

The common strands around student engagement are (Fry et al. , 2015):

- Institutional characteristics,
- Student characteristics,
- Setting high expectations,
- Identity, belonging and social interaction,
- Students managing their learning,
- Feedback and assessment,
- Teaching.

There is a strong correlation between these different strands (Kahu, 2013 referenced by Fry et al. , 2015).

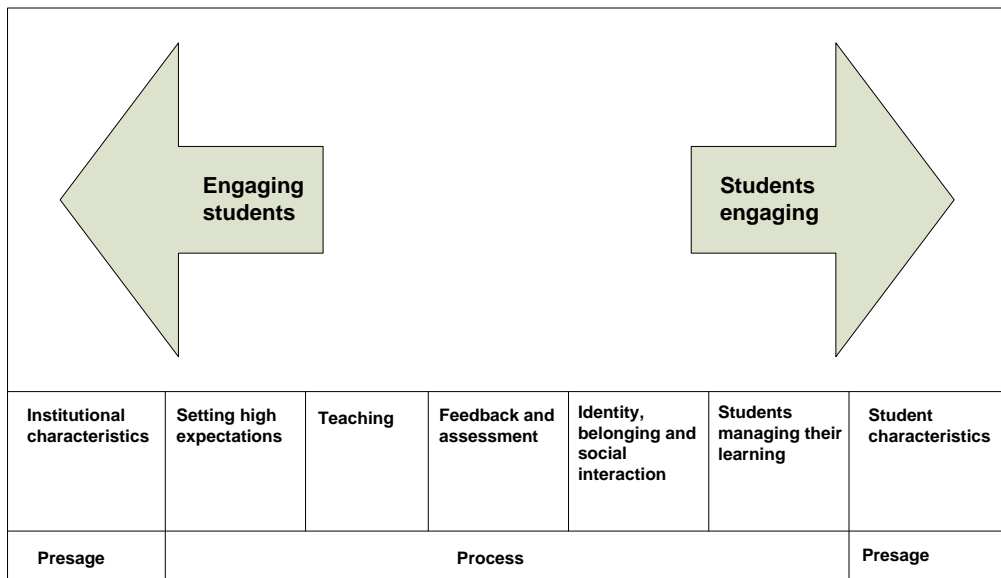


Figure 1. Engaging students (Fry et al. , 2015)

In Figure 1. is presented the continuum of student and institutional efforts to improve engagement, from clear institutional responsibilities at one end, importantly student responsibilities at the other, and joint engagement in the middle (Fry et al. , 2015). Figure 1. shows that it is not all down to the teacher, or to the student, or to the institution.

### Student engagement and quality teaching

Many authors stressed that teachers are key players in fostering student engagement (Akey, 2006; Garcia-Reid et al. , 2005). They work directly with the students and typically are the most influential in a student's educational experience. Creating a culture of achievement in their classroom, developing interactive and relevant lessons and activities, and being encouraging and supportive to students are all ways in which teachers can foster student engagement in the classroom.

Also, student engagement is most powerful as a driver of quality teaching when it involves dialogue, and not only information on the student's experience. As students are the intended beneficiaries of quality teaching, they are able to provide crucial "customer feedback" not only on what works well but also on what they would like to be done differently and how (Hénard & Roseveare , 2012).

In order to ensure that student engagement will lead to quality teaching, HEI should encourage and define a clear role of students in fostering quality teaching. One of the first steps on that way is building up trust between HEI and students by involving students in developing the teaching and learning framework and ensure that it incorporates what quality teaching means for them. Also, it is necessary to develop the capacity of student bodies to become reliable partners when consulted on teaching matters or when serving as representatives on relevant committees. Institutions should develop reliable instruments and techniques for gathering and using student feedback and convince students that institution will acted upon their feedback. When the teachers are in question, HEI should provide professional development for teachers to learn how to use student feedback most effectively to improve their teaching practice and provide incentives for programmes that implement methods to engage students in relevant and active learning, e. g. new curriculum, project-based learning, new methodologies, active learning classes, cooperative programmes, etc. (Hénard & Roseveare , 2012).

## RESEARCH METHODOLOGY

During the two academic years (2013/2014 and 2014/2015) the authors conducted empirical research on a convenience sample of bachelor students at Faculty of Economics University of Mostar who attended the course Accounting Information System (AIS). The aim of research was to investigate the students' perception of AIS course and way of its implementation. The authors developed two types of questionnaires and students fulfilled one at the first class – at the beginning of lectures, and the second at the last class – after the lectures and all activities related to continuous students' assessment (tests, project and seminar activities) were finished. The first questionnaire was about students' expectations from AIS lectures (content, their engagement, learning activities, learning outcomes, assessment), while the second questionnaire was about their real experiences related to AIS lectures. Data were analyzed in Microsoft Office Excel 2007 and expressed in absolute and relative frequencies (%).

## RESEARCH RESULTS

### The initial questionnaire – Students' expectations of the course AIS

In the first questionnaire students were asked to express their opinion about the course content. The question was open-ended. Also, through this questionnaire authors tried to find out whether the students looking for information about the course, either by asking older colleagues about course, or by themselves browsing Internet and looking for information about AIS. Distributions of students according to researched items in the years of research and in total are shown in the Table 1.

Table 1. Distributions of students

Group of students	2013/2014		2014/2015		Total	
	yes	no	Yes	no	yes	no
n	46		45		91	
Students looking information about	yes	no	Yes	no	yes	no
the AIS course, generally	25	21	25	20	50	41
the modalities of assessment at AIS	20	26	20	25	40	51
the teaching materials for AIS	16	30	15	30	31	60
the literature for AIS	9	37	16	29	25	66
A type of instruction at AIS	10	36	23	22	33	58
the necessity of AIS' class attendance	16	30	20	25	36	55



Results presented in Table 1. Shows that slightly less than half of the respondents did not even asked other about the course and they were expecting to be introduced with everything during lectures. It is interesting that when it comes to looking for information about AIS on the Internet almost all students have said no. Only six students stated that they had used Google for collecting information about "Accounting Information System" and 9 indicated that they are looking for other materials related to the course, too.

Expectations related to the teachers and the course is examined through the open questions. Some of the answers are shown in the Table 2.

Table 2. Some of students' expectations

Expectations of teachers (professor and assistant)	Expectations of teaching (lectures and exercises)
<ul style="list-style-type: none"> <li>• To be accessible for consultation</li> <li>• Try to explain everything and help us with ambiguity</li> <li>• Transfer their course knowledge to us on the best way, the lecture are interest and supported by examples from practice</li> <li>• Good clarifications</li> <li>• Do not be boring</li> <li>• To be interesting</li> <li>• The performers are friendly and collegial</li> <li>• Help in learning course content</li> <li>• A lot of new information and interesting things</li> <li>• To be fair and do not require much of us students</li> <li>• A lot of new information and interesting things</li> <li>• To be fair and do not require much of us (students)</li> <li>• To clarify and approach the subject matter of the course</li> <li>• Sufficient engagement and collaboration with students</li> <li>• To strive, to be always available and to have an understanding</li> <li>• Clearly explain without 20 lessons in a one lecture</li> <li>• Cooperation and delivering of quality knowledge</li> <li>• The fair and proper attitude towards the subject and students and to help students to increase their knowledge</li> <li>• A quality approach in the form of interesting and useful lectures</li> <li>• Detailed and understandable explanation</li> <li>• Professional approach and help</li> <li>• In order to see their desire to teach us something new</li> </ul>	<ul style="list-style-type: none"> <li>• Teaching is understandable to all students so they would be able to successfully pass this course</li> <li>• Introduction of accounting on practice</li> <li>• Understanding of the course and acquire new knowledge of AIS</li> <li>• To understand the content through practical examples</li> <li>• To learn and to master everything we needed for exams</li> <li>• Expect interesting lectures and exercises, team work, practical work</li> <li>• Successfully pass examination</li> <li>• To master the teaching material of the course</li> <li>• Lectures should be as specific and interesting as possible, and the exercises should adequately prepare me for the exam</li> <li>• To learn as much as possible</li> <li>• Facilitate understanding of the course</li> <li>• Much knowledge and practice</li> <li>• Passing exam</li> <li>• The acquisition of basic knowledge of AIS</li> <li>• That it will arouse interest for further investigation, study and learn about the AIS</li> <li>• Easily mastering accounting by using IT</li> <li>• Full schedule</li> <li>• Acquire new knowledge</li> <li>• To be interesting</li> <li>• More practical work on computers</li> </ul>

<ul style="list-style-type: none"> <li>• That will teach us by presenting their practical experience</li> <li>• To be patient</li> </ul>	
--	--

As it is evident from the above responses, part of them refers to the substance of the AIS, and part on the communication and interaction of stakeholders - teacher, assistant and students. The students were also asked about their opinion related to the organization of teaching process. They asked what kind of activities they expect in lectures and exercises: ex-cathedra lectures, practical work, a combination or something else. The majority of students, in both generations, pointed out that they expected combination (84. 8% in generation 2013/2014 and 75. 5% in generation 2014/2015). In accordance with this, only few students stated ex-cathedra lectures and practical work separately (approximately 12%), even none in the generation 2013/2014. More than 90% of students from both generations indicated that they expect the lectures abound with numerous practical examples through which is easier to understand the theory. Related to involvement of students, most of them expected a combination of individual and team work. Of course, there are a few of them who were only for individual work, and those who would like to settle all in the team. According to the students' opinions, the ratio of individual and team work should be 40%: 60% and the ratio of theory and practice 50%: 50%. From these ratios we can indicate the responsibility of students, because they recognize the importance of individual work and theory, not only teamwork and practical examples. It shows that their aim is not only to pass the exam but to acquire knowledge and skills that they will use in their future career after graduation.

### The final questionnaire - rating and review of course AIS

As highlighted in the methodology of the survey, after the end of the semester students through the second questionnaire have expressed their views about the realization of teaching process - they have commented organization, teachers, their success, and quality, what they learned and so on. At the second questionnaire the students were asked whether AIS course met their expectations and why. More than 90% of students answered yes. They believe that continuous work and their involvement are essential for successful realization. Students pointed that fact that at the beginning of AIS class they were asked about the expectations and organisation of the lectures and exercises, means a lot to them. It showed them that they are active stakeholders in the educational process.

According to the students' responses, the most common reasons for their high satisfaction with AIS course were: 1) because I learned something new, 2) because I could participate in class and prepare for the final exam, 3) because at the end of the semester I had passed the exams and get good mark, 4) because we worked differently than on the other courses, 5) because the continuous work is more interesting and different from the realization on the other courses, 6) because I had low expectations, but now I have a general information regarding AIS and realized its importance for company, 7) because we have taken the exam on interesting and unusual way, 8) because we were able to actively participate and present our ideas, 9) because there was no ex-cathedra lectures, students were constantly involved in the work and communication, 10) because in the team were only acquaintances not friends so working with them I made new friends. Last reason was worth additional explanation. Namely, one of the goals was that through the active and continuous work and collaboration, students learn to work in teams. Teachers started from the assumption that after graduation, when find the work, students will be in contact with different people (active, slow, innovatory, lazy, disciplined, etc. ) and they will need to cooperate with them if they want to succeed in their jobs. At the beginning of AIS class teams of five students were formed randomly. Their good grades and successfully passed the examination show that students managed to organize and collaborate well.

Of course, some students have pointed out what they didn't like, what is the lack of this kind of work and what should be improved for future generations. Among the disadvantages they mentioned: the physical space and a weekly schedule of lectures.

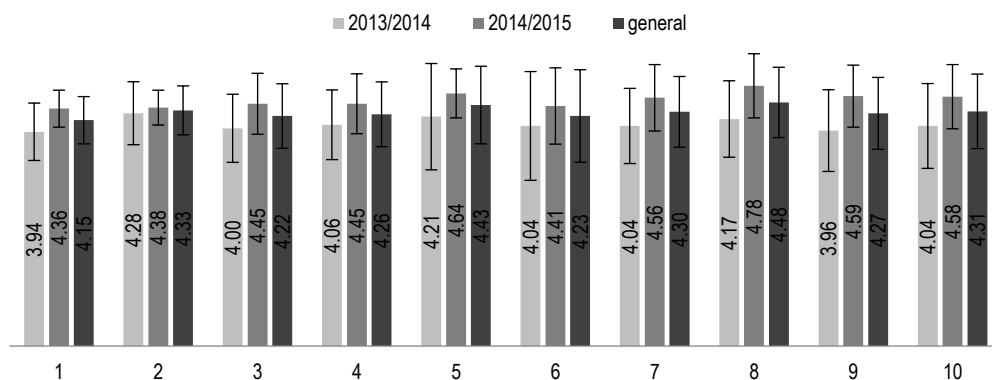
Weekly schedule is related to the organisation of lecturers at the level of the entire faculty and it is hard to influence on it. But, physical organization is a good observation. The classrooms are mainly organized for ex-cathedra lectures. Professor standing in front of students and teachers. Since the course is based on student involvement, the hall should be organized in another way. The goal would be that all see each other, but considering that the group has about 50-60 people it is a little difficult. So it would be nice to make work-tables for each team that would enhance their internal interaction in lectures.

In order to understand the expectations and desires of students, they were asked to evaluate their satisfaction with the realization of the AIS course. The results are shown in Table 3.

Table 3. Students' satisfaction with the realization of the course AIS

No	Item	Group	M±SD		
			2013/2014	2014/2015	Total
1.	Course content		3,94±0,53	4,36±0,34	4,15±0,43
2.	The content of exercises		4,28±0,58	4,38±0,32	4,33±0,45
3.	Course Organization		4,00±0,63	4,45±0,56	4,23±0,59
4.	Organization exercises		4,06±0,64	4,45±0,55	4,26±0,59
5.	Examination method		4,21±0,98	4,64±0,45	4,43±0,71
6.	Grading standards		4,04±1,00	4,41±0,70	4,23±0,85
7.	Practicality of Course		4,04±0,69	4,56±0,61	4,30±0,65
8.	The independence of students		4,17±0,70	4,78±0,59	4,48±0,65
9.	Satisfaction with College		3,96±0,75	4,59±0,57	4,27±0,66
10.	The degree of fulfillment of expectations		4,04±0,78	4,58±0,59	4,31±0,68

Graph 1 was used to better present the differences in means (Table 3. ).



Graph 1. Students' satisfaction with the realization of the AIS

From the data presented in the Table 4, and even better from the Graph 1, it can be seen that the means are relatively high, all above the mark 4. Comparing the ratings for the two analyzed years, it is evident that the means increased in 2014/2015. Namely, after the first year in which a new way of realization of the course (continuous student engagement) was introduced, the survey results were analysed in detail. Accordingly, some changes were made for the next year (2014/2015): more detailed practical work was introduced, students were more involved in the discussion, students got greater freedom in preparing their presentations, and direct student engagement was raised. Also, students got for more detailed instructions for their tasks and structuring tutorials by lessons which each group solves, so they were better prepared than former generation. Therefore higher students' satisfaction with AIS course in the year 2014/2015 could be expected.

## Conclusion

The findings of conducted research confirm the importance of students' engagement in teaching process. Also, results of research stressed the necessity of surveys among students, related to measures of students' satisfaction with quality of teaching process, with way of organisation and realisation of lectures and with a teachers' approach to course. But, surveys could not be an end in itself. The results of surveys should be carefully analyzed and appropriate actions taken. There is one interesting fact related to presented research – the questionnaires were better filled and students freely expressed their opinions in 2015 than in the first research conducted in 2014. The reason could lay in fact that in 2014 students had no experiences in such kind of surveys and they were unsure about potential consequences of hearty answers. Research showed that students asked their colleagues about their experience related to AIS course, so information through word of mouth obviously encourage students to freely express their opinions in 2015.

Research showed that students were looking for and appreciate when they were asked about teaching process and ways of its realisation, and of course, when saw that their opinions were analyzed and respected, meaning when saw that teacher tries to adapt teaching process and adjust it with their expectations and abilities.

Obviously, it is necessary constantly be alerted to students opinions and attitudes and ensure their engagement in teaching process, starting from course planning till the final realisation and assessment.

## References

- Akey, T. M. (2006). *School context, student attitudes and behaviour, and academic achievement: An exploratory analysis*. New York: MDRC. Available from: <http://www.mdrc.org/publications/419/full.pdf>, [Accessed 05 December 2014]
- Fry, H., Ketteridge, S., Marshall, S. (Eds.) (2015) *A Handbook for Teaching and Learning in Higher Education: Enhancing academic practice*, the Fourth edition, Available from: <https://books.google.ba/books?id=2fnTBAAAQBAJ&pg=PA168&lpg=PA168&dq=Student+engagement+in+fostering+quality+teaching+in+higher+education&source=bl&ots=6EjuFnZsQ&sig=12bGS7fkKrDyTbJZkBd2isOAiqY&hl=en&sa=X&ei=E2brVJnOIX8UMrvgdAG&ved=0CEQQ6AEwAzgK#v=onepage&q=Student%20engagement%20in%20fostering%20quality%20teaching%20in%20higher%20education&f=false>, [Accessed 20 February 2015]
- Garcia-Reid, P., Reid, R., & Peterson, N. A. (2005, May). School engagement among Latino youth in an urban middle school context: Valuing the role of social support. *Education and Urban Society*, 37 (3), 257–275.
- Healey, M., Flint, A., Harrington, K. (2014). Engagement through partnership: students as partners in learning and teaching in higher education, Available from: [https://www.heacademy.ac.uk/sites/default/files/resources/Engagement\\_through\\_partnership.pdf](https://www.heacademy.ac.uk/sites/default/files/resources/Engagement_through_partnership.pdf), [Accessed 12 January 2015]
- Hénard, F., Roseveare, D. (2012). *Fostering Quality Teaching in Higher Education: Policies and Practices*, Available from: <http://www.oecd.org/edu/imhe/QT%20policies%20and%20practices.pdf>, [Accessed 28 January 2015]
- Martin, P. (ed.) (2010). *Making space for creativity*, Brighton: University of Brighton, Retrieved 15. 12. 2013 from [https://www.brighton.ac.uk/creativity/Library/UofB\\_msfc-ebook\\_FINAL.pdf](https://www.brighton.ac.uk/creativity/Library/UofB_msfc-ebook_FINAL.pdf), [Accessed 18 December 2013]
- Rezić, S., Višekruna, V. (2012). "Priručnik za izradu nastavnih planova i programa temeljenim na ishodima učenja i kompetencijama", Sveučilište u Mostaru, kolovoz 2012.

---

## The Impacts of Political and Economic Uncertainties on the Tourism Industry in Turkey

Ebru Tekin

Boğaziçi University

ebrutekin@hotmail.com

### Abstract

*Turkey is one of the most visited countries by international tourists in the world. In 2013, the tourism receipts in the country increased by 11.4% compared to the previous year. More than 4 million Russian tourists visited Turkey in 2013, mainly on the Mediterranean region. Utilizing a case study approach, this study examines the impacts of the political and economic uncertainties on the tourism market in Turkey. The uncertainties are identified as follows: (1) global economic crises, (2) political instabilities between the EU and Russia, and (3) domestic and regional political instabilities. Based on the number of tourist arrivals and statistics on tourist flows, the study reveals that the tourism market in Turkey is indirectly affected by the political instability and following economic crisis in Russia. Furthermore, the domestic and regional political instabilities surrounding Turkey have not negatively affected tourist flows. This study contributes to the literature with an analysis on how uncertainties in state policies have an impact on the tourism market. The paper is based on secondary resources such as in-depth statistical data, country reports, industry forecasts as well as risk/reward and security ratings.*

**Keywords:** Tourism, uncertainty, policy, market, political instability, economic crisis

### Introduction

This study analyzes how the country's incoming tourism is affected by political and economic uncertainties by examining political instabilities and economic crises during the period of 2014-2015. This study provides two arguments: first, the existing literature on the relationships of tourism in regards to political instability and economic crises examines political instability and economic crises as two separate factors. Moreover, these studies examine these factors within a given country or region by observing their impacts on the concerned country or region; however, there is little literature that analyzes the interaction between political instability and economic crisis. This paper analyzes how political instability and economic crises are inter-related and how the interaction between these two factors has diverse impacts on the tourism sector. Second, this study contributes to the literature with an analysis on how uncertainties in state policies have an impact on the tourism market, specifically in Turkey. As such, the study analyzes uncertainties and risks as distinct constructs and identifies risk as "a state in which the number of possible events exceeds the number of events that will actually occur, and some measure of probability can be attached to them" (Stone & Gronhaug, 1993, 40, quoted from Quintal, et al., 2010, 798), and uncertainty has "no probability attached to it. It is a situation in which anything can happen and one has no idea what" (Hofstede, 2001, 148, quoted from Quintal, et al., 2010, 798).

Turkey has a mature and developed tourism market, which is based on culture and mass-market beach tourism. As tourism receipts and hotel occupancy statistics show, the sector is growing. According to the BMI forecast, it is expected that overall tourism receipts increase from an estimated USD 38.2 billion in 2014 to USD 48.3 billion by the end of our forecast period, which also signifies an increase on previous forecasts (BMI 2015, 19). In parallel to this statistics in growth trends, it is expected that the value of the hotel and restaurant industry will increase from USD 20.3 billion in 2015 to USD 25.3 billion in 2018 (p. 22). As these aforementioned statistics demonstrate, the tourism market in Turkey is characterized with a potential of strong growth (p. 27).

This study, providing a case study approach, examines the tourism market in Turkey in relation to the current regional political instabilities and economic crises. This study specifically analyzes the impacts of the political unrest in Crimea (started in February 2014) which resulted in an economic crisis in Russia. The political tension between the EU and Russia led to the decreasing number of Russian tourist arrivals to the EU. These developments, as deficits for the EU, actually created opportunities for tourism in Turkey. On another note, the increasing tourist arrivals to Turkey points out that tourists do not perceive a threat in relation to the regional political unrests in Syria and Iraq. Based on the number of tourist arrivals

---

and statistics on tourist flows, the study reveals that the tourism market in Turkey is indirectly affected by the political instability and following economic crisis in Russia. Furthermore, the domestic and regional political instabilities surrounding Turkey have not negatively affected tourist flows.

### Literature Review

The tourism industry has a complex nature, which shows how political, economic, social and cultural factors are interrelated with each other (Bergner & Lohmann, 2014)<sup>1</sup>. This study relates the impacts of political instability and economic crises on tourism in relation to uncertainty. In the literature, political instability is mostly identified with terrorism, unrest and political conflict in contrast to peace and stability (Sönmez, 1998; Sönmez & Graefe, 1998; Helmy, 2014). Morakabati (2013) identifies political instability in relation to conflicts, crises, instability, war, hostilities and instabilities. While Teye (1988) relates political instabilities to government changes and coups, Hall & O'Sullivan (1996) provide different dimensions of political instabilities such as international wars, civil wars, coups, terrorism, riots/political protests/social unrest, strikes (quoted from Sönmez, 1998, 448). Consistently, political instability is defined through political violence (Neumayer, 2004).

Yap & Saha (2013, 597) and Helmy (2014) identify political instability with uncertainty. Uncertainties are related to unexpected events that affect tourism demand such as "wars, terrorist attacks, natural disasters, epidemics, and financial crises" (Song and Lin, 2010, 17). Likewise, Hoti et al. (2005) analyze uncertainty in relation to "unexpected domestic and foreign economic, financial and political factors" (p. 2241). Bhattarai et al. (2005) identify political instability with political turmoil, "a situation that has created a crisis of authority in governance, and directional uncertainties in daily life" (p. 671) as well as a lack of stability and security (p. 686).

Dolnicar (2007) relates the term uncertainty to the "intangible nature of the tourism product" (p. 98) and associates the term with risk and perceived risk by tourists in their choice processes. Similarly, Fletcher and Morakabati (2008) analyze the effects of terrorism and political instability on the level of tourism activity and associate uncertainty with personal safety and security as well as risk perception. Floyd et al. (2004) examine the relationship between perceived risk and travel intentions and identify risks as financial risk, health risk, physical risk, crime risk, terrorism risk, social risk, psychological risk and risk of natural disasters.

Evans and Elphick (2005) study financial crises and crisis management in relation to uncertainties, which are identified as risks and vulnerabilities (p. 135). Steiner (2010) examines the impacts of political risk and violent political unrest on tourism FDI. As such, political unrest is related to political risk, which is differentiated from political instability; and this differentiation is embodied with the distinction between violent and non-violent political unrest. Steiner (2010) identifies international non-violent government interference as economic sanctions, foreign trade embargos, blockades and travel restrictions (p. 729). Uncertainty is defined in relation to high levels of anxiety, high levels of financial barriers, and low levels of benefits (Minnaert, 2014).

Smeral (2009) examines financial and economic crises in relation to tourism and analyzes the impacts of the crises on consumer behavior. Kozak et al. (2007) found that travelers change their travel plans on the basis of their risk perception such as the fear of disease, the lack of sanitation, the perceived risk of natural disaster or political dispute. Williams & Balaz (2014) use the concepts of uncertainty and risk interchangeably and argue that the two concepts are inherent to tourism in relation to the limited knowledge, such as the impossibility of storing unsold tickets and unoccupied accommodation (p. 1).

Silva et al. (2010) study risk in relation to unknowns. Uncertainties are identified as future unknowns in indicators, projections, and expectations (Smeral, 2010). Similarly, Hunter-Jones et al. (2008) relate uncertainty to unknowns and the lack of knowledge during the decision making process of tourists, which lead to the perceptions of fear and risk. Again, Bergner & Lohmann (2014) identify uncertainty with change and unforeseeable events such as climate change, changes in technologies, demographic change as well as changes in work situations and changes in tourist behavior, needs, and aspirations (p. 426-428). Minnaert (2014) associates uncertainty with risk, travel inexperience, lack of knowledge and financial uncertainty.

---

<sup>1</sup> Similarly, Rodriguez & Estevez (2007) associates perceived environmental uncertainty to a function of both complexity and dynamism.

Quintal et al. (2010) differentiates perceived risk from perceived uncertainty. Uncertainty and risk are rarely examined as “distinct constructs” (Quintal et al. , 2010, 797; Ghosh & Ray, 1992, 1997). However, this distinction is limited to the factors of financial loss, performance loss, physical loss, psychological loss, social loss and convenience loss; as well as their impacts of the probability of perceived risk and the perceived uncertainty.

The studies that measure the extent to which the factors of political instability and terrorism affect tourism market reveal different ranking of variables. For instance, according to the study on tourist concerns that would prevent tourists from booking their trip; war/military conflict ranked at 79 percent; life threatening diseases with 59 percent; an act of terrorism with 56 percent; the lack of access to clean food and water with 46 percent; and political instability with 46 percent (Dolnicar, 2007). According to another study, while war and political instability are the most weighted risks to pre-travel decisions, terrorism is the least significant (Hunter-Jones et al. , 2008, 245). Similarly, Yap & Saha (2013) evaluated the effects of political instability, terrorism, and corruption on tourism development and their study revealed that although terrorism has negative impacts on the market, its effect on tourism is lower than that of political instability. Ranga and Pradhan (2014) show that despite terrorist attacks, tourist arrivals increased and tourism flourished in India. Similarly, the figure below shows that despite political instabilities, the number of tourist arrivals in the Middle East increased between the years 1950 and 2010 (Morakabati, 2013) (Figure 1).

### **Political and Economic Uncertainties**

This section examines political and economic uncertainties as global economic crises, political instabilities between the EU and Russia, and domestic and regional political instabilities.

#### ***Global Economic Crisis***

The relationship of tourism and economic crisis is associated with uncertainty in “the duration, depth, and implications of the global economic crisis” (Papatheodorou et. al. 2010, 39) and how such uncertainty is transmitted into the tourism industry as economic volatility (p. 44). Since the global economic crisis, inbound travel to Turkey increased from 31. 7 million arrivals in 2012 to 37 million in 2014. According to the BMI forecast, the arrivals to the country are expected to increase to 44. 9 million by 2018. It is also estimated that Europe will continue to be the main region to constitute Turkey’s inbound tourism; yet, other regions such as the Middle East and Asia Pacific will send more tourists to Turkey by 2018 (BMI, 2015, 15). The diversity in the source of tourist arrivals to Turkey is seen as an advantage for the country in relation to the political and economic instabilities.

The 2008–2009 global economic crises resulted in a decrease of international tourist arrivals by 4 percent and a decrease of international tourism revenues by 6 percent in 2009 (UNWTO, 2013). Despite these declines, the tourist arrivals to Turkey continued to increase in 2008 and 2009 (Turizm, 2015) (Figure 2).

The intensity and duration of the impacts of the global economic crisis on the tourism market vary dependent on the region. Similar to Turkey, the Middle East and the Caribbean countries were less affected and managed to recover the negative affects at a quicker pace. Likewise Africa’s international tourism industry was not affected by the crisis (UNWTO, 2013).

#### ***Political Instabilities between the EU and Russia***

Russian travelers have become the main source of tourists for both the EU and Turkey. In 2013, 32 million Russian travelers visited Europe, composing the third largest source for Europe (ETC, 2014). Similarly, with more than 4 million tourist arrivals, Russians make-up the second largest source for Turkey (BMI, 2015). However, the political instabilities between Ukraine and Russia over Crimea, which resulted in economic and political crises, have changed travel trends in these markets (ETC, 2014). According to the report published by the European Travel Commission,

---

*“While the European tourism sector is not a direct target of international sanctions introduced in response to the crisis, it does suffer indirectly. The weakening Rouble, partly a by-product of deteriorating trade relationships, has progressively reduced outbound travel from Russia. The climate of economic uncertainty, fear of hostile attitudes towards Russians and deteriorated visa processing, amplified by media coverage, contribute to diverting travel from Russia to non-European destinations. (ETC, 2014)”*

The impacts of political instabilities on the tourism market vary in different countries. Whereas the top tourism destinations for Russia, which are Finland, Lithuania, Switzerland and Czech Republic, were mostly negatively affected; Latvia, Cyprus and Turkey, which pose neutral positions, received an increasing number of Russian tourists (ETC, 2014).

Russian tourist arrivals to Turkey have dramatically decreased in 2014 due to the decrease in consumer spending confidence in Russia, which is based on the decrease in global oil prices. Additionally, due to the impacts of the EU's sanctions and visa complications for Russian nationals, tourist arrivals from Russia is expected to grow, by almost a million between 2014 and 2018. Moreover, the close political and economic ties between the governments of Russia and Turkey may result in increasing touristic activities between the countries (BMI 2015, 17).

According to the report published by the European Travel Commission, the change in the travel flows from Russia has also been affected by the decreasing purchasing power of Russian travelers due to the depreciation of the Rouble against the Euro (ETC, 2014). For instance, it is expected that Finland will be most affected by the depreciation of the Rouble due to the country's close proximity to Russia and the significance of daily trips and shopping of Russian travelers to Finland (EurActiv, 2014). However, it is also expected that the depreciation of the Rouble will lead to an increase in tourist flows to European destinations that are not as costly to visit, such as Turkey, Greece and Hungary (ETC, 2014).

Turkey has been receiving an increasing number of Russian tourists. During the political instability between Russia and the Ukraine, Turkey refused to apply sanctions despite the fact that EU candidate countries are invited to share in sanctions being imposed. Therefore, Turkey has emerged as a main destination for Russian travelers. As a result of current sanctions, every country shows diverse results of Russian tourist arrivals. Turkey showed a significant increase as well as Greece and Cyprus, compared to the overall performance of the EU countries (ETC, 2014).

Spain, which is the second largest destination of Russian tourists after Turkey, has been experiencing a slowdown in Russian arrivals at almost a 5 percent decrease in growth in the early months of 2014. Poland is another country that is expected to experience the highest decrease in tourist arrivals from Russia, which corresponds to almost a 32 percent decrease in the number of Russian travelers. Similar to Poland, Germany and Italy experienced significant decreases in Russian tourist arrivals (ETC, 2014). According to the report of the European Travel Commission, the removal of the economic sanctions may have a negative impact on Turkey. It is forecasted that even a small change in percentage growth rates might be associated with a large number of people and changes at the total European level (ETC, 2014).

### **Domestic and Regional Political Instabilities**

Turkey is a well-developed destination that offers a variety of options ranging from historical, cultural and natural attractions to sea-sun-sand tourism with beach resorts, festivals, activity holiday options and medical tourism (BMI 2015, 27). Despite this strong positioning, the forecast reports mention that “these developments are dependent on the maintenance of a stable political and security environment in the country over the forecast period” (p. 27). The possible threats to the stability include political instabilities such as anti-government protests; the treatment of PKK; and the conflict in Syria and Iraq, with their spillover effects. Nevertheless, it is expected that none of these threats will have a direct impact on tourism outside Istanbul (p. 27).

On 6 January 2015, a police building in Sultanahmet, one of the main touristic places in Istanbul, was attacked by a suicide bomber. A police officer and the assailant were killed. Following this terrorist attack, many travel warnings were published by government agencies. According to the Australian Government's Department of Foreign Affairs and Trade, the advice was published on their website on 07 January 2015:



---

“... The overall level of advice has not changed. We advise Australians to reconsider their need to travel to within 50 kilometres of the borders with Syria. We continue to advise Australians to reconsider their need to travel to the provinces of Hakkari, Sirnak and Siirt, which border Iraq and Iran and to exercise a high degree of caution elsewhere in Turkey because of the threat of terrorist attack (Smarttraveller, 2015).”

Similarly, according to the UK Government's foreign travel advice, the threats of demonstrations and terrorism were explained and the advice was as follows:

*“The Foreign and Commonwealth Office (FCO) advise against all travel to within 10 km of the border with Syria. The FCO advise against all but essential travel to:*

- *the remaining areas of Sirnak, Mardin, Sanliurfa, Gaziantep, Kilis and Hatay provinces*
- *Siirt, Tunceli and Hakkari provinces.*

*Over 2,500,000 British nationals visit Turkey every year. Most visits are trouble-free. (GOV. UK, 2015)”*

While regional political instabilities can threaten Turkey's tourism, there are avenues for growth. For instance, political upheaval in competitive countries in tourism, such as Egypt, may lead to increases in tourist arrivals in Turkey, which may result in the growth in the hotel sector. Terrorist attacks and the political instabilities in Syria and Iraqi borders constitute a main threat for inbound tourism to Turkey but these threats have yet to come to fruitions.

### **Tourism Market Forecasts**

According to the forecast reports, the investment plans of the top hotel chains declare confidence in the strengths of Turkey's tourism market and the popularity of Turkey as a tourism destination. More importantly, the increase in tourist arrivals, especially among high-spending tourists from the Middle East and Russia sustains the growth in tourism investment in Turkey.

According to the BMI report, the top 10 hotel chains have currently a presence in Turkey, which signifies a well-established environment for tourism. The top hotel chains include Accor Hotels, Best Western, Carlson Rezidor Hotel, Choice Hotels International, Hilton, Hyatt, Intercontinental Hotels, Marriott, Starwood, and Wyndham. More importantly, the investments of these chains have planned to expand in 2015. For instance, Wyndham operates 34 hotels in Turkey as of 2015, up from just 14 hotels in 2014. Similarly, Hilton has rapidly expanded in 2015 with 34 hotels including the new Hilton Istanbul Bomonti Hotel and Conference Centre located in Istanbul. In addition to this, Hilton plans to open its 50<sup>th</sup> hotel in Turkey, the 147-room Hampton Izmir, in early 2016. Accor and Best Western have also planned to continue expansion in the next two years (BMI, 2015).

Domestic investors have in parallel, boosted Turkey's tourism sector. For instance, Dedeman opened new hotels in Antalya, Zonguldak, İstanbul Bostancı, Gaziantep as well as in Kazakhstan and Erbil. Also, new hotels are under development in İstanbul Levent and İstanbul Bostancı. It is expected to see an increase in hotel numbers of more than 1,300 between 2015 and 2018; and thus, a slight decline in occupancy rates to over 31 percent is expected (BMI, 2015, 21) (Table 2).

According to the BMI forecast, Turkey has a Tourism Risk/Reward Index score of 53. 7, placing the country in 13<sup>th</sup> place in the region of Central and Eastern Europe. The reward scores for tourism take into account the numbers and percentage growth of tourist arrivals over the past year and the BMI's forecasts for future growth. Turkey receives a tourism market score of 60. 00, which is above average for the region (BMI 2015, 25).

Despite the strong presence of Turkey's tourism industry, the risk/reward ratio takes into account weaknesses such as the anti-government protests and “the poor state of parts of the domestic infrastructure” (p. 25). These factors decreased the reward ratio of potential returns to 53. 4. Similarly, since there are also weaknesses in the country structure, the reward ratio is decreased to 43. 5 (Table 3).

As regards to risk scores, this score “offers an evaluation of industry-specific dangers and those emanating from the state’s political and economic profile that call into question the likelihood of anticipated returns being realised over the assessed time period” (BMI 2015, 25). Turkey has a risks to realisation of potential returns score of 54. 3.

The market risks score considers short-term political stability and regional stability, as well as vulnerability to external factors. The score for Turkey is better for domestic political stability with the score of 51. 5 in the market risks column. As regards to country risk score, it covers aspects such as legal framework, bureaucracy, market openness and security risks. Country’s risk score of Turkey is fairly well with the score of 56. 5.

## Conclusion

This study analyzes the impacts of political and economic uncertainties on the tourism market in Turkey. The factors of political instabilities and economic crises intertwine with each other and their impacts have been differently in Turkey than in other countries. While the economic sanctions of the EU applied to Russia negatively affected the Russian tourist flow to the EU, it positively affected the tourism market in Turkey with an increase in Russian tourist flows.

This study analyzes how the country’s inbound tourism is affected by political and economic uncertainties by examining the dynamics of the political economy with a particular attention to political instabilities and economic crises. This study contributes to the literature with an analysis on how uncertainties in state policies have an impact on the tourism market in Turkey. This study does not assume a priori that risks and uncertainties are inherent in tourism.

Despite political and economic uncertainties such as global economic crises, political instabilities between the EU and Russia, and domestic and regional political instabilities, the tourism market in Turkey has not been impacted negatively. According to the BMI forecast (BMI, 2015), it is expected that overall tourism receipts will continue to increase. The tourism market in Turkey is characterized with a potential of strong growth. Based on the number of tourist arrivals and statistics on tourist flows, the study reveals that the tourism market in Turkey has indirectly affected by the political instability and following economic crisis in Russia. The domestic and regional political instabilities in Turkey have neither affected the tourist flows. In parallel to the current literature, the impacts of political instabilities on tourism are more significant than the impacts of terrorism. As regards to risk ratios, the tourism market in Turkey secures its strong position. However, despite its position of strength, the positive growth expectations are dependent on the maintenance of a stable market environment in Turkey.

## REFERENCES

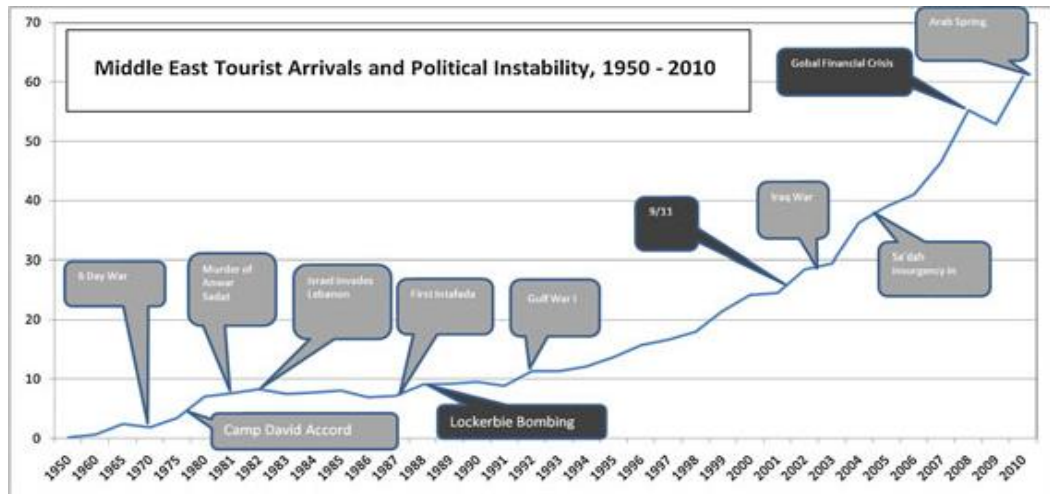
- Bergner, N. M. , & Lohmann, M. (2014). Future Challenges for Global Tourism: A Delphi Survey. *Journal of Travel Research*, 53 (4), 420-432.
- Bhattarai, K. , Conway, D. , & Shrestha, N. (2005). Tourism, terrorism and turmoil in Nepal. *Annals of Tourism Research*, 32 (3), 669-688.
- BMI. (2015). *Business Monitor International Turkey Tourism Report Q1 2015*. BMI: UK.
- Chen, C. , & Chiou-Wei, S. Z. (2009). Tourism expansion, tourism uncertainty and economic growth: New evidence from Taiwan and Korea. *Tourism Management*, 30 (6), 812-818.
- Dolnicar, S. (2007). 'Crises' that Scare Tourists: Investigating Tourists' Travel-Related Concerns. University of Wollongong Research Online.
- ETC. (2014). *European Tourism amid the Crimea Crisis*. European Travel Commission. Brussels.
- EurActiv. (2014). *Finland warns Russia sanctions could spell 'economic crisis'* [online tutorial]. Retrieved from <http://www.euractiv.com/sections/europes-east/finland-warns-russia-sanctions-could-spell-economic-crisis-307769>
- Evans, N. , & Elphick, S. (2005). Models of crisis management: An evaluation of their value for strategic planning in the international travel industry. *International Journal of Tourism Research*, 7 (3), 135-150.

- Fletcher, J. , & Morakabati, Y. (2008). Tourism activity, terrorism and political instability within the commonwealth: The cases of Fiji and Kenya. *International Journal of Tourism Research*, 10 (6), 537-556.
- Floyd, M. F. , Gibson, H. , Pennington-Gray, L. , & Thapa, B. (2004). The effect of risk perceptions on intentions to travel in the aftermath of September 11, 2001. *Journal of Travel and Tourism Marketing*, 15 (2-3), 19-38.
- Ghosh, D. , & Ray, M. (1992). Risk attitude, ambiguity intolerance and decision making: an exploratory investigation. *Decision Sciences*, 23 (2), 431-444.
- Ghosh, D. , & Ray, M. (1997). Risk, ambiguity, and decision choice: some additional evidence. *Decision Sciences*, 28 (1), 81-104.
- GOV. UK. (2015). *Foreign travel advice Turkey* [online tutorial]. Retrieved from <https://www.gov.uk/foreign-travel-advice/turkey>
- Hall, C. M. , & Sullivan, V. O. (1996). Tourism, Political Stability and Violence. In: Pizam, A. , and Y. Mansfeld, (eds. ) *Tourism, Crime and International Security Issues*, pp. 105-121. New York: Wiley.
- Helmy, E. M. (2014). "Political Uncertainty". In E. Fayos-solà, M. D. Alvarez & Chris Cooper (eds. ). *Tourism as an Instrument for Development: A Theoretical and Practical Study (Bridging Tourism Theory and Practice, Volume 5)*. Emerald Group Publishing Limited, p. 301-315.
- Hofstede, G. (2001). *Culture's consequences: Comparing values, behaviors, institutions and organizations across nations*. Beverly Hills, CA: Sage Publications.
- Hoti, S. , & McAleer, M. , & Shareef, R. (2005). Modelling country risk and uncertainty in small island tourism economies. *Tourism Economics*, 11 (2), 159-183.
- Hoti, S. , & McAleer, M. , & Shareef, R. (Anonymous). *Modelling Volatility Spillovers And Causality In International Tourism And Country Risk For Cyprus And Malta*. [Online Tutorial]. Retrieved from [http://www.mssanz.org.au/modsim05/papers/hoti\\_4.pdf](http://www.mssanz.org.au/modsim05/papers/hoti_4.pdf)
- Hunter-Jones, P. , & Jeffs, A. & Smith, D. (2008). Backpacking Your Way into Crisis. *Journal of Travel & Tourism Marketing*, 23: (2-4), 237-247.
- Kozak, M. , & Crotts, J. C. , & Law, R. (2007). The impact of the perception of risk on international travellers. *International Journal of Tourism Research*, 9 (4), 233-242.
- Minnaert, L. (2014). Social tourism participation: The role of tourism inexperience and uncertainty. *Tourism Management*, 40: 282-289.
- Morakabati, Y. (2013). Tourism in the Middle East: Conflicts, Crises and Economic Diversification, Some Critical Issues. *International Journal of Tourism Research*, 15, 375-387.
- Neumayer, E. (2004). The Impact of Political Violence on Tourism: Dynamic Cross-National Estimation. *Journal of Conflict Resolution*, 48 (2), 259-281.
- Papatheodorou, A. , & Rossell, J. , & Xiao, H. (2010). *Global economic crisis and tourism: Consequences and Perspectives*, 49 (1), 39-45.
- Quintal, V. A. , & Lee, J. A. , & Soutar, G. N. (2010). Risk, uncertainty and the theory of planned behavior: A tourism example. *Tourism Management*, 31, 797-805.
- Ranga, M. , & Pradhan, P. (2014). Terrorism terrorizes tourism: Indian Tourism effacing myths?. *International Journal of Safety and Security in Tourism*, 5, 26-39
- Rodriguez, J. R. , & Estevez, V. Y. (2007). Perceived environmental uncertainty in tourism: A new approach using the Rasch model. *Tourism Management*, 28, 1450-1463.

- Silva, O. , & Reis, H. & Correia, A. (2010). The moderator effect of risk on Travel Decision Making. *International Journal of Tourism Policy*, 3 (4), 332–347.
- Smarrtraveller. (2015). *Turkey Latest Update*. [Online Tutorial] Retrieved from <http://www.smartraveller.gov.au/zw-cgi/view/Advice/Turkey>
- Smeral, E. (2009). The impact of the financial and economic crisis on European tourism. *Journal of Travel Research*, 48 (1), 3-13.
- Smeral, E. (2010). Impacts of the world recession and economic crisis on tourism: Forecasts and potential risks. *Journal of Travel Research*, 49 (1), 31-38.
- Song, H. , & Lin, S. (2010). Impacts of the Financial and Economic Crisis on Tourism in Asia. *Journal of Travel Research*, 49 (1), 16-30.
- Sönmez, S. F. (1998). Tourism, Terrorism, and Political Instability. *Annals of Tourism Research*, 25 (2), 416-456.
- Sönmez, S. F. , & Graefe, A. R. (1998). International Vacation Decisions and Terrorism Risk. *Annals of Tourism Research*, 25 (1), 112-144.
- Steiner, C. (2010). An Overestimated Relationship? Violent political unrest and tourism foreign direct investment in the Middle East. *International Journal of Therapy and Rehabilitation*, 12 (6), 726-738.
- Stone, R. , & Gronhaug, K. (1993). Perceived risk: further considerations for the marketing discipline. *European Journal of Marketing*, 27 (3), 372–394.
- Teye, V. B. (1988). Coups d'Etat and African Tourism: A Study of Ghana. *Annals of Tourism Research*, 15: 329-356.
- Turizm. (2015). *Tourist Arrivals to Turkey (2002-2012)*. [Online Tutorial]. The Ministry of Tourism and Culture. Retrieved from <http://sgb.kulturturizm.gov.tr/Eklenti/29269,gelen-yabanci-ziyaretci-sayisi.pdf?0>
- UNWTO. (2013). *Economic Crisis, International Tourism Decline and its Impact on the Poor*. World Tourism Organization and International Labour Organization, UNWTO, Madrid.
- Williams, A. M. , & Balaz, V. (2014). Tourism risk and uncertainty: Theoretical Reflections, *Journal of Travel Research*, February 24, 2014, 1-17.
- Yap, G. , & Saha, S. (2013). The moderation effects of political instability and terrorism on tourism development: A cross-country panel analysis. *Journal of Travel Research*, 53 (4), 509-521.

## Tables and Figures

Figure 1: Middle East tourist arrivals and political instability, 1950–2010



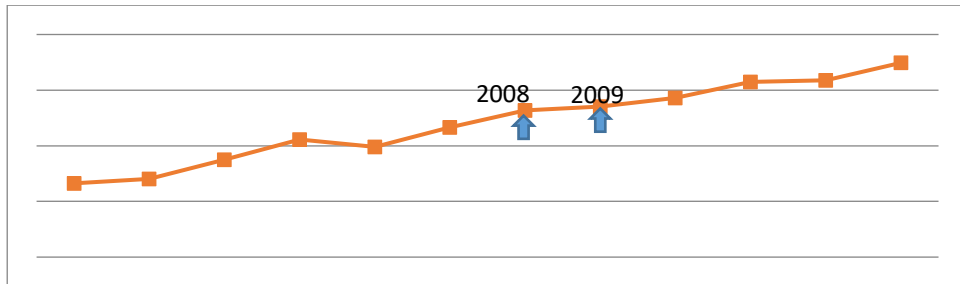
Source: Morakabati, 2013, p. 377.

Table 1: Inbound Tourism, Top 10 Markets by Arrivals '000 (Turkey 2011-2018)

	2011	2012	2013	2014e	2015f	2016f	2017f	2018f
Germany	4,826.3	5,028.7	5,041.3	5,534.4	5,508.9	5,553.7	5,698.3	5,890.2
Russia	3,468.2	3,599.9	4,269.3	3,190.0	3,459.7	3,729.4	3,999.2	4,268.9
United Kingdom	2,582.1	2,456.5	2,509.4	2,680.7	2,706.0	2,765.9	2,811.1	2,870.7
Bulgaria	1,491.6	1,492.1	1,582.9	1,777.6	1,776.1	1,829.6	1,932.7	2,070.3
Georgia	1,152.7	1,404.9	1,769.4	1,904.6	2,092.3	2,329.4	2,573.8	2,925.2
Netherlands	1,222.8	1,273.6	1,312.5	1,500.7	1,477.7	1,502.6	1,572.6	1,665.5
Iran	1,879.3	1,186.3	1,196.8	1,272.4	1,612.0	1,770.3	1,989.4	2,231.7
France	1,140.5	1,032.6	1,046.0	1,230.9	1,205.0	1,209.4	1,256.3	1,323.3
USA	757.1	771.8	786.0	876.8	920.8	963.6	1,004.7	1,061.0
Syria	974.1	730.0	1,252.8	1,252.8	1,252.8	1,252.8	1,252.8	1,252.8

Source: BMI, 2015, 17.

Figure 2: Tourist Arrivals to Turkey (2002-2012)



Source: Turizm, 2015.

Table 2: Hotel Accommodation (Turkey 2011-2018)

	2011	2012	2013	2014e	2015f	2016f	2017f	2018f
Occupancy Rate %	33.9	34.2	32.8	32.0	31.6	31.3	31.2	31.1

Source: BMI, 2015, 22.

Table 3: Reward and Risks Ratios

	Reward			Risks				Rank
	Limits of potential returns	Tourism market	Country structure	Risks realisation to potential returns	Market risks	Country risk	Tourism index	
Slovenia	58.80	46.67	76.99	69.44	61.71	75.77	61.99	1
Estonia	51.50	45.00	61.24	76.85	67.27	84.69	59.10	2
Hungary	52.91	38.33	74.78	72.48	63.35	79.95	58.78	3
Cyprus	54.22	55.00	53.04	69.36	57.48	79.08	58.76	4
Armenia	57.71	48.33	71.78	58.73	61.77	56.25	58.02	5
Poland	55.95	48.33	67.38	60.68	50.46	69.03	57.37	6
Montenegro	55.38	45.00	70.95	59.81	66.35	54.46	56.71	7
Latvia	51.15	41.67	65.38	67.91	59.23	75.01	56.18	8
Belarus	57.99	50.00	69.98	50.52	63.75	39.70	55.75	9
Lithuania	49.00	43.33	57.50	70.47	60.05	79.00	55.44	10
Moldova	54.97	56.67	52.43	55.87	57.79	54.29	55.24	11
Kazakhstan	53.19	46.67	62.98	59.36	69.06	51.42	55.04	12
Turkey	53.40	60.00	43.49	54.26	51.50	56.51	53.65	13

Source: BMI, 2015.

---

## Functional Textile Preferences of Elderly People

Sema Palamutcu

Imren Goren

Pamukkale University, Engineering Faculty,  
Textile Engineering Department, Denizli –Turkey  
spalamut@pau.edu.tr

### Abstract

*Aging is an inevitable stage of lifetime bringing along physical and emotional deterioration. Rate of aging population in the world has been constantly rising with the contribution of technological improvements on life quality, and medical services. Depending on the unavoidable physical and emotional changes of aging human body, clothing preferences and needs become different then needs of other textile and clothing consumer groups. Textile and clothing products are one of the basic needs of human kind. Sufficient and appropriate clothing is especially important for life quality improvement at elderly stage of human life. New generation functional and smart textile and clothing products bring new opportunities to improve life quality of elderly people with such wide range products of mobility support clothing, medical help, hygiene, and health monitoring textile and clothing products. This survey based research work is aimed to search the awareness level and priority of society about the functional and smart textile products for elderly people. It has been found that gender difference has significant influence on preference level of functional textile products, where women has higher interest then men about functional textiles. It can also be stated that comfort properties are primarily preferred preferences comparing to the fashion and functionality properties of textile products.*

**Keywords:** Elderly people, functional textiles, smart textiles

### 1. Introduction and literature review

Average living time of human being is steadily increasing. As result of the longer life time the number of people in the aging<sup>1</sup> group is also increasing. Currently 8,3% of World population is over 65 years old and it is estimated that this rate will be about 16% in 2050 (Ur1).

Consumer based needs of aging population is different than other consumer groups. There are several studies concerning their behaviors and special needs of elder consumers. In the study of Richards (1981) clothing preferences and problems of elderly female consumers are researched. Jackson (1992) had studied spending patterns of elderly consumers (age 60 and above) on personal apparel. Shim (1993) had researched differences in satisfaction with the fit of apparel purchased through catalogs and catalog attributes among three groups (petite, medium, and tall) of women 55 years and older. Goldsberry (1996-a, 1996-) had focused on women 55 years and older about their current body measurements and overall satisfaction and dissatisfaction with the fit of ready-to-wear clothing. Vural (2008) had studied body size standardization in terms of underwear production of women over 60 years old. In the report of Meinander (2002) problems that can occur concerning clothing and textiles for disabled and elderly people are identified and suggestion has been offered to solve their problems where possible. Civitci (2004) has focused on the ergonomic garment design for elderly Turkish men that she has determined elderly men's demands, needs and problems in regard to clothing and to design an ergonomic garment in the light of the knowledge. Joung (2006) has questioned the factors of dress affecting self-esteem in older females. It has implemented that in order to maintain self-esteem in old age, individuals should be encouraged to participate in social activities and appearance management activities; the fashion and personal care industry should have an awareness of

---

<sup>1</sup> At the moment, there is no United Nations standard numerical criterion, but the UN agreed cutoff is 60+ years to refer to the older population (Ur 2).

older female consumers' needs and develop and provide age-related products and services. Pisut (2007) has studied fit preferences of female consumers in the USA. Mona, Mak Man Nga (2011) has completed a thesis, namely "Study and design of elderly aesthetic apparel", in Bachelor of Arts (Honors) In Fashion & Textiles program in Institute of Textiles & Clothing the Hong Kong Polytechnic University. Her aim was to understand the elderly clothing in general, including wearing requirements, wearing difficulties, clothing preferences and design an aesthetic-oriented elderly apparel which helps to improve the design, materials usage and address potential problem; and find out the real situation and demands toward garments of elderly in Hong Kong. Chattaraman (2013) has focused on the age, body size, body image, and fit preferences of male consumers in their statistically study. They have offered important implications and created actionable market information on fit strategy for male consumer segments. Twiggy (2014) had addressed debates around the changing nature of old age, using UK data on spending on dress and related aspects of appearance by older women to explore the potential role of consumption in the reconstitution of aged identities.

Textile and clothing products are one inevitable consumer product for human being. Beside the basic use purposes of covering and protection; textile and clothing products had started to have some more additional features. Classical form of textile and clothing products are in significant progress stage that moves forward becoming technical, functional, and smart textile products. The expertise gained from many years of research is being more intimately married with expertise from other engineering, scientific and design sectors, giving rise to a new breed of functional and smart technologies (Tang 2005). The term "smart" in textile and clothing products includes meaning of functionality and has been used to refer to materials that can sense and respond in a controlled or predicted manner to environmental stimuli, which can be delivered in mechanical, thermal, chemical, magnetic or other forms (Tao, 2001). The difference between functional and smart textile products can be defined as responding ability presence of the product. Functional textile products are those products that they may only provide permanent or temporary additional features of antimicrobial, fire retarding, stain resistive, antistatic, quick drying, odor resistive, etc. properties; where smart textile products provide direct and indirect responses.

Interest of functional and smart textile and clothing product has lately grown exponentially. Promising sub divisions of functional and smart textiles are military textiles, geotextiles, medical textiles, sport and leisure textiles, wearable electronics, and transportation textiles. Special products designed to improve and help elderly people is also one rising sub sector of functional and smart textiles. This product group is an intersection of other current functional and smart textile product groups which are medical textile, wearable - electronic textiles, sport textiles, and protective textiles. Market penetration and commercialization of such special products are rising as result of gradual reduction of component costs, rising consumer interest and improving technologies.

Market share of those special textile products for elderly people is also growing as result of increasing share of elderly people in the society. Another main driving force behind the market growth is consumer purchase power in the developed countries. Especially baby boomer generation<sup>1</sup> has become retired with their cash build up and pensions that is easily spendable for their own health care and any other expenses to improve their life quality and help them to live independent and longer.

Survey suggests that aging is associated with physical and emotional changes which can be repaired, accomplished and cared using some external products. Gender, age group, and education level are selected as dependent variables questioning preferences and awareness level about functional and smart textile products for elder people.

## 2. Objectives of the Study

Presented study is aimed searching the following objectives:

1. Exploring the attitudes of the society about functional textile and clothing products regarding the gender, age and education differences.

---

<sup>1</sup> The Baby Boomers are defined as those born between 1945 and 1964 in USA and in Europe.



2. Exploring the significance of product properties and consumer performance criteria expectations among society regarding the gender, age and education differences.
3. Comparing the general expectations and views of participants based on their own knowledge about elderly functional and smart textile and clothing products.

### 3. Method of the Research

Questionnaire form has built up in three parts of demographic data, five levels Likert Scale measurement of textile product property priorities, and five level Likert Scale measurements of elderly textile products. Participants are answered 39 questions of three parts in total, using face to face survey method. In total 212 valid participants from Pamukkale University-Denizli/Turkey, and Retired Teacher House in Muğla/Turkey is responded to the questions. Five level Likert Scale data and its weight values are given in Table 1.

Table 1: Five level Likert Scale and weights of responses

Responses	weights
certainly not agree	1
not agree	2
uncertain	3
agree	4
Strongly agree	5

Questionnaire has four main part, which are part I: demographic data of gender, age, and education level; part II: 20 questions about general awareness level of functional and smart textile products; part III: 9 questions of general expectations about functional and smart textile; and part IV: 10 questions about awareness and interest to functional and smart textile products designed specifically for elderly people. Likert scale based answers of the questions are then recorded, and used for the estimation of median, standard deviation, and significance (at %95 confidence intervals) values.

### 4. Findings and results

Demographic data of the participants are presented in Figure 15, for total of 212 participants. Rate of female participants in total is 55%; rate of participants aged between 18-25 is 38 %, 25-40 is 8 %, 40-60 is 37 %, and 60+ is 17%; and education level of participant rates are elementary school is 7%, high school is 11% and university graduates is 82%.

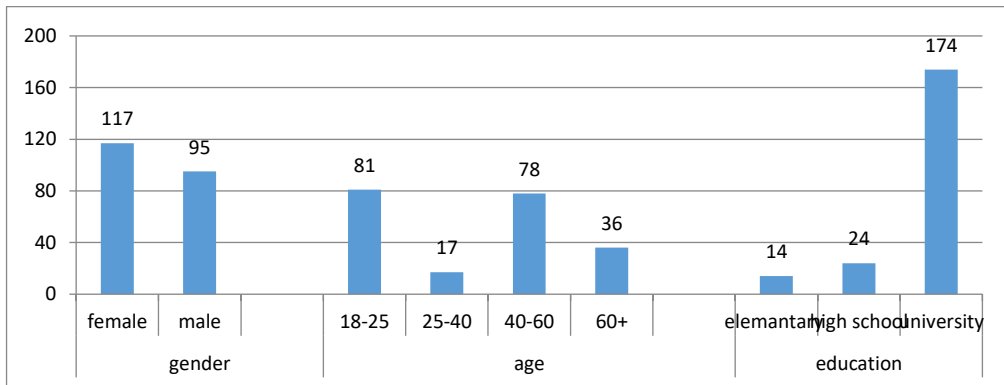


Figure 15: Demographic data of participants

Responses of participants to the questions in Part II of the survey Part II are given in Table 2. There are 20 statements presented to the participants, in order to control and compare the general awareness level about functional and smart textile and clothing products. The participants are required to choose their agreement levels of each statement in Likert Scale. 11 statements out of 20 is found non significantly different among the participant responses, where they are defined as having homogenous variances of all participants. . Statements that are determined as having homogeneous variance are "Dirt and stain repellency in T & C is important for me", "Size stability in wool T & C is important for me", "Shiny surfaced fabric use in T & C is important for me", "Anti-static ability in T & C is important for me", "Wound healing ability in T & C is important for me", "Heat storage and management ability in T & C is important for me", "Cooling in T & C is important for me", "Head ache curing ability in head covering products is important for me", "Odor releasing ability in T & C is important for me", "High elasticity in in T & C is important for me", "Quick drying in T & C is important for me".

In general evaluation of the participant responses, it is seen that female participants and age group of 40-60 are more likely to have interest about functional and smart textiles comparing to the male and other age group of participants.

Table 2: Questions, medians, standard deviations, F and significance values of Part II

question nr.	question		gender		age groups				education level			F	significance
			Female	Male	18-25	25-40	40-60	60 +	elementary school	high school	university		
2. 1.	Softness in T & C* is important for me.	$\bar{X}$	4,68	4,55	4,51	4,47	4,79	4,56	4,79	4,67	4,60	4,272	0,00
		S	0,47	0,66	0,57	1,01	0,41	0,50	0,43	0,48	0,59		
2. 2.	Breathing ability in T & C is important for me.	$\bar{X}$	4,71	4,66	4,58	4,71	4,76	4,78	4,79	4,75	4,67	4,107	0,00
		S	0,46	0,56	0,54	0,47	0,49	0,42	0,43	0,44	0,52		
2. 3.	Creaseless in T & C is important for me.	$\bar{X}$	4,66	4,39	4,69	4,59	4,42	4,42	4,57	4,29	4,57	2,57	0,001
		S	0,56	0,78	0,54	0,51	0,78	0,73	0,85	0,86	0,63		
2. 4.	Fire retarding ability in T & C is important for me.	$\bar{X}$	4,07	4,09	3,83	3,76	4,31	4,31	4,00	4,17	4,07	3,115	0,00
		S	1,06	1,00	1,08	1,15	0,90	1,01	1,24	1,13	1,01		

2. 5.	Dirt and stain repellency in T & C is important for me.	Ĥ	4,38	4,29	4,40	4,24	4,38	4,19	4,14	4,08	4,40	1,575	<b>0,074</b>
		S	1,00	0,82	1,03	0,83	0,86	0,86	1,17	1,14	0,87		
2. 6.	Antimicrobial efficiency in T & C is important for me.	Ĥ	4,44	4,48	4,31	4,00	4,60	4,72	4,64	4,54	4,44	2,706	0,001
		S	0,92	0,67	1,01	0,94	0,59	0,51	0,50	0,59	0,86		
2. 7.	Size stability in wool T & C is important for me.	Ĥ	4,57	4,58	4,64	4,53	4,55	4,50	4,57	4,46	4,59	1,498	<b>0,099</b>
		S	0,78	0,77	0,69	0,87	0,83	0,77	0,94	0,93	0,74		
2. 8.	Pilling -less ability in T & C is important for me.	Ĥ	4,78	4,65	4,81	4,53	4,77	4,50	4,79	4,71	4,72	2,955	0,000
		S	0,51	0,73	0,48	0,87	0,42	0,97	0,43	0,46	0,65		
2. 9.	Shiny surfaced fabric use in T & C is important for me.	Ĥ	3,10	2,86	3,12	3,12	2,97	2,69	3,93	2,79	2,95	1,618	<b>0,063</b>
		S	1,16	1,05	1,02	1,17	1,18	1,12	0,92	1,22	1,08		
2. 10.	Drape ability in T & C is important for me.	Ĥ	3,69	3,58	3,63	3,65	3,57	3,83	4,14	3,50	3,62	2,062	0,01
		S	1,05	1,02	0,93	1,11	1,15	0,97	0,66	1,18	1,03		
2. 11.	Anti-static ability in T & C is important for me.	Ĥ	4,50	4,32	4,33	4,24	4,49	4,56	4,57	4,54	4,39	1,498	<b>0,099</b>
		S	0,82	0,83	0,89	0,97	0,72	0,81	0,51	0,59	0,87		
2. 12.	Wound healing ability in T & C is important for me.	Ĥ	4,09	4,03	4,10	3,76	4,03	4,19	4,36	4,04	4,04	1,367	<b>0,157</b>
		S	0,95	0,92	0,92	1,09	0,93	0,92	0,74	1,00	0,94		
2. 13.	Massage effected T & C is important for me.	Ĥ	3,43	3,52	3,60	3,41	3,35	3,44	3,64	3,54	3,44	1,822	0,028
		S	1,22	1,06	1,21	1,00	1,15	1,08	0,84	1,38	1,14		
2. 14.	UV protective property in T & C is important for me.	Ĥ	4,21	4,40	4,21	4,18	4,31	4,53	4,29	4,17	4,32	2,396	0,002
		S	0,97	0,72	0,92	0,88	0,87	0,74	0,91	1,20	0,82		
2. 15.	Heat storage and management ability in T & C is important for me.	Ĥ	4,10	4,20	4,16	3,88	4,17	4,19	4,23	4,13	4,14	1,239	<b>0,238</b>
		S	0,92	0,84	0,87	0,99	0,86	0,92	1,01	0,90	0,88		
2. 16.	Cooling in T & C is important for me.	Ĥ	4,32	4,27	4,35	4,12	4,27	4,33	4,50	4,29	4,28	1,42	<b>0,131</b>
		S	0,83	0,78	0,88	0,86	0,78	0,63	0,65	0,75	0,82		
2. 17.	Head ache curing ability in head covering is important for me.	Ĥ	3,74	3,74	3,79	3,71	3,74	3,64	4,00	3,88	3,70	0,698	<b>0,803</b>
		S	1,20	1,11	1,24	1,10	1,12	1,13	1,30	1,15	1,15		
2. 18.	Odor releasing ability in T & C is important for me.	Ĥ	3,82	3,53	4,12	3,24	3,58	3,17	4,07	3,67	3,66	1,453	<b>0,117</b>
		S	1,26	1,22	1,16	1,25	1,16	1,34	1,14	1,31	1,25		
2. 19.	High elasticity in T & C is important for me.	Ĥ	4,41	4,28	4,44	4,29	4,27	4,33	4,36	4,13	4,38	1,325	<b>0,181</b>
		S	0,86	0,85	0,74	0,92	1,00	0,76	0,84	0,99	0,84		
2. 20.	Quick drying in T & C is important for me.	Ĥ	4,37	4,13	4,51	4,24	4,16	3,94	4,21	4,22	4,27	0,793	<b>0,700</b>
		S	0,98	0,94	0,87	1,03	1,00	0,98	0,89	0,90	0,99		

\*: T & C stands for the term of textile and clothing product

Responses of participants to the questions in Part III of the survey are given in Table 3. There are 9 statements presented to the participants, in order to control and compare the general expectations and performance criteria knowledge of functional and smart textile and clothing products. 1 statements out of 10 is found non significantly different among the participant responses, where they are defined as having homogenous variances of all participants. Statement that are determined as having homogeneous variance is "Functionality in T & C\* is important for me", which is clearly understand among participants of the survey. The other statements are determined as non-homogeneously variance statements, where understanding and knowledge about them are not homogeny among participants.

In general evaluation of the participant responses, it is seen that female participants are more focused about fashion, aesthetic and functionality, where male participants are more focused on price, quality, and long lasting property of products.

Table 3: Questions, medians, standard deviations, F and significance values of Part III

question nr.	question		gender		age groups				education level			F	significance
			Female	Male	18-25	25-40	40-60	60 +	elementary school	high school	university		
3. 1.	Fashion in T & C* is important for me.	χ	3,82	3,44	3,89	2,94	3,55	3,67	3,71	3,63	3,65	1,907	0,019
		S	1,13	1,26	1,13	1,56	1,16	1,17	1,27	1,28	1,20		
3. 2.	Strength, long life and steadiness in T & C* is important for me.	χ	4,59	4,49	4,57	4,41	4,60	4,47	4,57	4,46	4,56	2,569	0,001
		S	0,63	0,67	0,67	1,00	0,52	0,65	0,51	0,78	0,64		
3. 3.	Wellness and good feeling in T & C* is important for me.	χ	4,67	4,49	4,75	4,24	4,56	4,44	4,57	4,54	4,60	3,799	0,00
		S	0,56	0,67	0,43	0,83	0,64	0,69	0,51	0,83	0,59		
3. 4.	Material quality in T & C* is important for me.	χ	4,40	4,57	4,46	4,41	4,49	4,53	4,08	4,58	4,49	2,074	0,009
		S	0,79	0,63	0,79	0,71	0,74	0,56	1,19	0,65	0,69		
3. 5.	Ratio between quality and price in T & C* is important for me.	χ	4,38	4,44	4,11	4,29	4,64	4,61	4,71	4,71	4,34	2,885	0,00
		S	0,92	0,78	1,10	0,77	0,56	0,60	0,47	0,46	0,91		
3. 6.	Easy cleaning in T & C* is important for me.	χ	4,68	4,54	4,70	4,59	4,56	4,53	4,71	4,58	4,61	2,183	0,006
		S	0,51	0,56	0,51	0,51	0,55	0,56	0,47	0,50	0,55		
3. 7.	Price in T & C* is important for me.	χ	4,40	4,52	4,35	4,71	4,48	4,50	4,71	4,63	4,40	1,977	0,014
		S	0,91	0,62	0,88	0,47	0,77	0,74	0,47	0,58	0,83		
3. 8.	Functionality in T & C* is important for me.	χ	4,44	4,27	4,36	4,18	4,39	4,39	4,29	4,35	4,37	1,586	<b>0,071</b>
		S	0,72	0,75	0,76	0,81	0,75	0,64	0,91	0,88	0,71		
3. 9.		χ	4,84	4,73	4,84	4,76	4,76	4,75	4,79	4,83	4,78	8,476	0,00

Comfortable movement in T & C* is important for me.	S	0,39	0,45	0,37	0,56	0,43	0,44	0,43	0,48	0,41		
---	---	------	------	------	------	------	------	------	------	------	--	--

\*: T & C stands for the term of textile and clothing product

Responses of participants to the questions in Part III of the survey are given in Table 4. There are 10 statements presented to the participants, in order to control and compare the general awareness of elderly textile and clothing products. 4 statements out of 10 is found non-significantly different among the participant responses, where they are defined as having homogenous variances of all participants. Statements that are determined as having homogeneous variance are "Direction mentioning vibration shoes are important for elder people", "GPS purposed T&C products are important for elder people", "Body vital signal watching T&C products are important for elder people", and "Skin caring, cosmetic T&C products are important for elder people", which are clearly understand among participants of the survey. The other statements are determined as non-homogeneously variance statements, where understanding and knowledge about them are not homogeny among participants.

Table 4: Questions, medians, standard deviations, F and significance values of Part IV

question nr.	question	gender		age groups				education level			F	significance	
		Female	Male	18-25	25-40	40-60	60 +	elementary school	high school	university			
4. 1.	High absorbent, leakage free underwear is important for elder people.	X̄	4,74	4,58	4,74	4,71	4,62	4,61	4,50	4,83	4,66	1,964	0,017
		S	0,63	0,59	0,52	0,59	0,71	0,64	0,85	0,38	0,62		
4. 2.	Odor engaging underwear is important for elder people.	X̄	4,74	4,46	4,80	4,65	4,51	4,39	4,43	4,71	4,61	4,448	0,00
		S	0,61	0,78	0,43	0,86	0,72	0,96	0,51	0,69	0,72		
4. 3.	Breathing underwear is important for elder people.	X̄	4,75	4,62	4,74	4,65	4,68	4,64	4,57	4,75	4,70	1,808	0,033
		S	0,51	0,62	0,52	0,61	0,50	0,76	0,65	0,44	0,57		
4. 4.	Body heat protective underwear is important for elder people.	X̄	4,76	4,56	4,72	4,65	4,70	4,50	4,64	4,74	4,66	3,779	0,00
		S	0,52	0,71	0,64	0,61	0,54	0,74	0,50	0,45	0,65		
4. 5.	Cooling T&C products are important for elder people.	X̄	4,47	4,16	4,43	4,35	4,22	4,31	4,21	4,26	4,34	2,049	0,012
		S	0,76	0,95	0,79	0,93	0,95	0,79	1,05	0,86	0,85		
4. 6.	Direction mentioning vibration shoes are important for elder people.	X̄	3,98	3,68	3,99	3,88	3,90	3,42	3,64	4,29	3,80	1,497	0,104
		S	1,12	1,03	1,05	0,99	1,08	1,18	1,01	1,12	1,08		
4. 7.	GPS purposed T&C products are important for elder people.	X̄	4,13	3,89	4,17	4,29	3,95	3,72	3,71	4,21	4,02	0,942	0,522
		S	1,10	1,04	1,06	0,92	1,10	1,09	1,07	1,18	1,06		
4. 8.	Religious record playing T&C products are important for elder people.	X̄	2,99	2,43	3,26	3,00	2,27	2,44	3,57	3,00	2,64	2,599	0,001
		S	1,33	1,42	1,39	1,22	1,26	1,38	1,09	1,38	1,40		

4. 9.	Body vital signal watching T& C products are important for elder people.	Ā	4,10	3,97	4,36	4,41	3,78	3,72	3,64	4,04	4,07	1,597	0,073
		S	1,05	1,08	0,80	0,94	1,18	1,16	1,15	1,20	1,04		
4. 10.	Skin caring T&C products are important for elder people.	Ā	3,41	3,29	3,62	3,06	3,16	3,36	3,36	3,70	3,32	1,464	0,117
		S	1,35	1,24	1,36	1,03	1,29	1,22	1,08	1,22	1,32		

## 5. Results and discussion

Functional and smart textile and clothing market is constantly growing with higher acceleration than the regular textile and clothing market. Technology levels of such products are giving promises to the consumer about more comfortable, more health caring, more safety, more reliability and wellness. Such special products are opening new markets for the aging population in the developed countries. Market penetration and commercialization ratio of such innovative special products are rising as result of gradual reduction of component costs, rising consumer interest and improving technologies.

Functional and smart textile products manufacturing enterprises are expected to respond to the voice of elder people market. Consumer desires and expectations in such dynamic market need to be covered immediately. Influential factors behind the purchasing behavior of such special consumer group needs to be defined, understand and responded clearly.

The results of the study have shown that there are differences between different gender, age and education level groups. When compared the approaches of female and male participants to the statements, consumers pay attention to the functional textile and clothing products. There are some gaps in the market both in supplier and consumer sides.

### Acknowledgement

This study is part of a graduate thesis work, and authors are grateful to the Scientific Research Program of Pamukkale University for the financial support.

## 6. References

- 1-Url 1: "Percentage of the World Population Over 65 - 1950-2050" by Rcragun - Own work. Licensed under CC BY 3. 0 via Wikimedia Commons - [http://commons.wikimedia.org/wiki/File:Percentage\\_of\\_the\\_World\\_Population\\_Over\\_65\\_-\\_1950-2050.png#mediaviewer/File:Percentage\\_of\\_the\\_World\\_Population\\_Over\\_65\\_-\\_1950-2050.png](http://commons.wikimedia.org/wiki/File:Percentage_of_the_World_Population_Over_65_-_1950-2050.png#mediaviewer/File:Percentage_of_the_World_Population_Over_65_-_1950-2050.png), access date : 26. 02. 2015
- 2-Richards, M. L. (1981), The Clothing Preferences and Problems of Elderly Female Consumers, *The Gerontologist* (1981) 21 (3): 263-267.
- 3-Jackson, H. O. (1992), Aging and Expenditures on Apparel, *Clothing and Textiles Research Journal* January, vol. 10 no. 2 24-28
- 4-Shim, S. , Bickle, M. C. (1993), Women 55 Years and Older as Catalog Shoppers: Satisfaction with Apparel Fit and Catalog Attributes, *Clothing and Textiles Research Journal* June, vol. 11 no. 4 53-64
- 5-Goldsberry, E. , Shim S. , and Naomi Reich, N. (1996), Women 55 Years and Older: Part I Current Body Measurements As Contrasted to the PS 42-70 Data, *Clothing and Textiles Research Journal* March, vol. 14 no. 2 108-120
- 6- Goldsberry, E. , Shim S. , and Naomi Reich, N. (1996), Women 55 Years and Older: Part II. Overall Satisfaction and Dissatisfaction with the Fit of Ready-to-Wear, *Clothing and Textiles Research Journal* March, vol. 14 no. 2 121-132
- 7-Vural, T. , Çileroğlu, B. , Çoruh, E. (2008), Body size standardization in terms of underwear production of women of 60 years and above, *Tekstil ve Konfeksiyon*, 2/2008
- 8-Harriet Meinander H. , Varheenmaa, M. , *Clothing and textiles for disabled and elderly people*, VTT TIEDOTTEITA – Research Notes 2143, ISBN 951–38–5897–9

- 
- 9-Civitci Sule, (2004), An ergonomic garment design for elderly Turkish men, *Applied Ergonomics*, Volume 35, Issue 3, May, Pages 243–251
- 10-Joung, H. , Miller, N. J. , (2006), "Factors of dress affecting self-esteem in older females", *Journal of Fashion Marketing and Management: An International Journal*, Vol. 10 Iss 4 pp. 466 - 478
- 11-Pisut, G. , & Connell, L. J. (2007). Fit preferences of female consumers in the USA. *Journal of Fashion Marketing and Management*, 11, 366–379.
- 12-Mak Man Nga, M. (2011), Study and design of elderly aesthetic apparel", in Bachelor of Arts (Honors) In Fashion & Textiles program in Institute of Textiles & Clothing the Hong Kong Polytechnic University
- 13-Chattaraman, V. , Simmons K. P. , and Ulrich, P. V. (2013) Age, Body Size, Body Image, and Fit Preferences of Male Consumers, *Clothing and Textiles Research Journal* 31 (4) 291-305
- 14-Twigg, J. , Majima, S. , (2014) Consumption and the constitution of age: Expenditure patterns on clothing, hair and cosmetics among post-war 'baby boomers, *Journal of Aging Studies* 30 (2014) 23–32
- 15-Lam Po S. , Tang L. P. , G. K. Stylios, (2006), "An overview of smart technologies for clothing design and engineering", *International Journal of Clothing Science and Technology*, Vol. 18 Iss 2 pp. 108 - 128
- 16-Tao, X. (2001), *Smart Fibers, Fabrics and Clothing*, CRC Woodhead Publishing Ltd, Cambridge.

---

## Age as a Determining Factor in L1 and L2 Acquisition

**Antonija Šarić**

Josip Juraj Strossmayer University of Osijek,  
Faculty of Food Technology Osijek, Kuhačeva 18, 31000 Osijek, Croatia

**Lidija Obad**

Josip Juraj Strossmayer University of Osijek,  
Faculty of Food Technology Osijek, Kuhačeva 18, 31000 Osijek, Croatia

### Abstract

*This paper deals with L1 and L2 acquisition and factors which inhibit or stimulate this acquisition. It is generally agreed that L1 acquisition is neurologically, psychologically and cognitively conditioned and there is a critical period for a morphosyntactic language acquisition. However, certain aspects of L1 development can extend far into adulthood. When considering L2 acquisition, special attention is paid to the critical period which extends to the age of nine due to neurological and biological factors. Cerebral flexibility enables direct language acquisition aspiring to achieve native speaker's standard regarding the phonological and morphological aspects and the access to Universal Grammar. Early language acquisition requires less cognitive effort supporting the idea that less is more. Some latest discoveries, however, dispute this claim arguing that brain plasticity is not lost at that age. Emphasis is also given to the exercise hypothesis relating to the idea that capacity for language learning remains lifelong provided the learners start language exercise at an early age. On the other hand, maturation state hypothesis advocates that capacity for language learning declines with maturation regardless the exercise. When discussing L2 acquisition and nativelike ultimate attainment three various hypotheses are taken into consideration. The first one claims that native speaker's level is achievable only by child starters. The second one supports the former hypothesis adding that it is possible not only to child starters but also to individual late starters. The third hypothesis disputes these claims stating that nativelike ultimate attainment cannot be achieved by any of those learners.*

**Keywords:** L1, L2 acquisition, critical period, nativelike ultimate attainment, child and late starters

### Introduction

The issue of possible existence of an age factor in language development is a topic which generates a great interest and encourages fierce debates. The study of the age factor stretches far back into history, though systematic research commenced in the 1960s. Thorough overviews of such research can be found in the works of David Singleton (2005), Singleton and Ryan (2004) Birdsong (1999), and Nikolov (2009). The reasons for emergence of further discussions on the age factor in language development are derived from both theory and practice. The theoretical side can be explained by the fact that there is an interaction between the limitation faced by adult students when acquiring language and the idea that language development is backed by special biological programming, whereas the practical side involves the assertion that young learners of the second language possess an advantage over the older ones. That assertion becomes a frequent topic when discussing about an optimal age to start second language learning at school (Singleton and Ryan, 2004).

What remains controversial in this light is the issue whether there is an exclusively neurologically dependent critical period after which language acquisition is not possible any more or is greatly hampered. It might be that after childhood, the ability of language acquisition gradually declines as a result of the interaction between neurological, cognitive, psychological and social factors.



### Critical period for L1 acquisition

Studies of the critical period for first language acquisition are scarce, mostly due to the fact that only few children could not acquire their mother tongue naturally and hence the presence of such a critical period has often been researched based on the language of people who have suffered brain damage followed by aphasia. The above studies have facilitated the conclusion that brain damage appearing at an early age implies a higher probability of full recovery, i. e. when there is still a possibility of language development. Confirmation of the existence of such a critical period is provided by children who were deprived of normal childhood and thus of first language acquisition (Steinberg, Nagata and Aline, 2001, as cited in Medved Krajnović, 2010).

The story of a boy named Victor who lived in the first half of the 19<sup>th</sup> century serves as an acknowledgement of a critical period for first language acquisition. At the age of 12, the boy showed up in the French village of Aveyron, walked on four legs and produced inarticulate sounds. The boy's upbringing was trusted to Dr. Itard who worked at the Institute for People with Hearing Impairment in Paris and who attempted to acquaint the boy with social and linguistic behaviour. The boy managed to get used to some social norms, but he never learned more than a few words while due to his short life, his inability of language acquisition has never been clarified. It is still unclear if his inability resulted from skipping the critical period for language acquisition or from poor raising conditions or from some other congenital disorder.

The story of a psychically and physically abused girl named Genie who was put in a dark room at the age of just 20 months and kept there by her father who would only enter the room to bring her the food or to empty the chamber pot to which she was attached to, is even more prominent. The father did not communicate with her at all but only growled at her and when she tried to get into any kind of contact with him, he would beat her. The girl was found in Los Angeles in the 1970s when she was 13 years old. After having been taught for four years, she acquired vocabulary typical for five year-olds, but she had problems with syntax. She spoke telegraphically and could not comprehend complex grammatical structures. Although there is more available information about Genie's childhood, one still faces the issue about the cause of the inability of development of normal language skills. Is it a result of a late exposure to language learning or a consequence of the brutal living conditions?

On the other hand, there are plenty of proofs that the first language development continues long after puberty. While researching the morphology of the first language of Dutch pupils aged from 7 to 17, Smedts (1988 as cited in Singleton and Ryan, 2004) revealed that his seven year old examinees were, in average, familiar with only 14 % of the Dutch morphology, the 13-year olds knew only 51 % of the rules in question and the 17 year old children were acquainted with more than 66 % of these rules. In fact, some aspects of the development of the first language go deep into adulthood.

Singleton (1989) drew the conclusion that if a child is exposed to any language in normal circumstances, he/she adopts the language fairly fast following the universal developmental pattern. It implies that children say their first words at the age of one, they significantly expand their vocabulary when they are two, and use two words in combination, when they turn three, a rise in their syntactic complexity and development of functional morphemes is manifested and when they are five, their entire linguistic system is shaped.

### Critical period for L2 acquisition

In 1959, Penfield and Roberts, shared the opinion in their work, entitled *Speech and Brain Mechanisms*, that children can acquire their second language more efficiently due to neurological and biological factors. They collected evidences which encouraged them to claim that "after the age of nine, for the purposes of learning languages, the human brain becomes progressively stiff and rigid." (Penfield and Roberts, 1959 as cited in Singleton and Ryan, 2004). They advocated the idea that children should be introduced to the second language early in life since "when languages are taken up for the first time in the second decade of life, it is difficult to achieve a good result because it is unphysiological" (Penfield and Roberts, 1959 in Singleton and Ryan, 2004).

In their opinion, the child's brain possesses certain capacity for language learning and there might be a biological clock therein. They proposed a limit of about nine years of age until which there is cerebral flexibility that enables direct learning through information input. These scientists also explained lower levels of language acquisition as a consequence of a late start of language learning. According to them, children begin to think analytically at the age of nine and learn the second

language through the first one. While investigating cases which involved recovery after aphasia, Lundeberg (1967) noticed that the examined children quickly regained their speaking ability that was not the case with adults. He explained that according to the theory, brain cell lateralization begins approximately at the age of two and ends before puberty. This theory is supported by the brain plasticity hypothesis, namely, in case of an injury of the left hemisphere during childhood, the brain remains flexible, plastic enough, to let other parts take over the language function. As children grow up, this plasticity vanishes (Hyltenstam and Abrahamson, 2003).

However, Lundeberg (1967) thinks that adults can learn a foreign language as well, which does not deny the theory of the critical period since:

- a) adults are privileged as they have already learned one language, which means that some fundamental principles do not have to be acquired later;
- b) adults are mature in the cognitive context and good at learning the aspects of the second language via learning mechanisms which are generally well used by them and adolescents, defined as explicit learning;
- c) adults were not able to reach the standard of native speakers, particularly in the area of pronunciation despite the cognitive maturity and great efforts.

A certain number of authors who do not necessarily embrace the concept of critical period laid down by Lenneberg support, nevertheless, the idea that post-puberty second language learning is more conscious and difficult. Krashen, Scarcella and Long (1979) disclosed the following conclusions on second language acquisition:

- 1) adults make more progress in the initial acquisition stages as far as morphology and syntax are concerned;
- 2) older children acquire language faster than the young ones (in the light of morphology and syntax);
- 3) children are superior to adults in the long run.

In the 1970s, the existence of a critical period for language acquisition was much discussed and resulted in opposing opinions, which is why Krashen, Scarcella and Long (1979) divided the studies into two groups:

- a) the first group encompassed those studies which dealt with the early beginnings of language learning;
- b) the second one with the conclusions related to ultimate attainment. In the end, the authors drew the conclusion that older learners acquire some aspects of language faster than the young ones in the beginning, but young learners (particularly children) soon catch up with the former and finally surpass them. Although the last conclusion does not specifically involve ultimate attainment (Long, 1990 in Hyltenstam and Abrahamsson, 2003), research shows that young learners can, though rarely, reach the level of native speakers, which is almost impossible regarding grown-ups.

Numerous studies of the linguistic competence of immigrants reveal that it is much better to be exposed to the second language at an early age (Asher and Garcia, 1969; Patkowski, 1980 in Hyltenstam and Abrahamsson, 2003; Johnson and Newport, 1989). Johnson and Newport (1989) offer two interpretations of the theory of the critical period:

- a) the first theory was entitled Exercise Hypothesis. It suggests that people possess superior capacity for language acquisition at an early age and if this capacity is not exercised on time, it gradually disappears or declines as individuals get older. If it is used, other language skills stay intact.
- b) the second theory was called Maturational State Hypothesis. In line with this theory, people have superior capacity for language acquisition which disappears or declines with the process of maturation. The two theories represent different implications of the age factor in second language acquisition. According to the Exercise Hypothesis, learners who were not in touch with the first language during their childhood are not capable of acquiring the second language later on. However, if they acquire the first language in their childhood, their capacity for second language acquisition should not be impaired and is expected to be exercised at any age or in other words, children and adults are equal when it comes to second language acquisition and thus age does not matter in this context.

On the other hand, the Maturational State Hypothesis propagates that there is something extraordinary about the development of the child's brain that enables children to adapt to the acquisition of the first or second language. It also assumes the standpoint that the capacity for second language acquisition declines regardless of its exercise. In compliance

with the latter hypothesis, age does matter in terms of second language acquisition. Both hypotheses can be interpreted if ones take into account the initial level concerning second language acquisition or ultimate attainment of learners of different ages and the capacity of acquiring various linguistic domains, which declines by time. According to the aforementioned, adults advance more rapidly at the initial language acquisition levels (Krashen, Long and Scarcella, 1979) while children catch up with the grown-ups in the end (Singleton, 1989).

The capacity for second language acquisition that declines over time can be observed through the morphological, phonological and syntactic domain. Johnson and Newport (1989) investigated the syntactic competence of Korean and Chinese children aged 3 to 39 by assessing their grammatical accuracy to evaluate the attainment of English as the second language with respect to their different age of arrival in the United States of America. The authors agreed that the syntactic performance of learners drops with the age of arrival in a foreign country, revealing a sharp decline between 14 and 16 years of age while children who came to America between three and seven years of age achieved results at the native speakers' level. Using a sample of 23 Chinese learners of English as the second language, who came to the USA at the age from 18 to 38, Johnson and Newport (1991) studied the acquisition of linguistic universals. The results disclosed that linguistic universals became less accessible to learners as they get older. Furthermore, the authors share the opinion that the changes occurring between childhood and adulthood have an effect on all the aspects of grammar acquisition, including the access to the Universal Grammar.

Regarding the morphological domain, Harley (1986) studied the level of acquisition of the French verb system in Canada using two groups of learners after 1000-hours language course and the data were collected by means of interviews and translation exercises. According to Harley, neither group managed to completely master the verb system, but the older groups achieved poorer results, demonstrating that the ability of second language acquisition declines even in the morphological domain. With respect to the phonological domain, Oyama (1976 in Dong and Ren, 2013) researched the accent of 60 immigrants to America aged between 5 and 18 rated by the native speakers. They concluded that children who moved to America at an early age did not have a foreign accent unlike those who were older than 12 when they came to the USA, which proves that the phonological competence of second language acquisition deteriorates by time as well. Second language acquisition (from the viewpoint of the initial level of acquisition or as ultimate attainment) depends on the early beginning of learning. The loss of the acquisition competence during the critical period gives relevance to the Maturational State Hypothesis, i. e. age influences second language acquisition. The research conducted by Johnson and Newport has remained dominant with respect to the limitations of maturation and critical period.

Concerning the age factor and second language acquisition, Bley-Vroman (1988, as cited in Medved Krajnović, 2010) offered a fundamental difference hypothesis, according to which adults acquire second languages in a way different from that of children, i. e. children unconsciously take advantage of the congenital structure of the Universal Grammar, whereas adults apply their knowledge of the first language (mother tongue) to utilize general learning mechanisms, i. e. their analytical skills while considering the organization of the second language. Accordingly, adult learners possess two privileges – the native language and general problem-solving ability which supplement each other or better to say, the native language opens up a path to the Universal Grammar and the general problem-solving ability is activated in analysing second language data, though this cooperation cannot compensate for the loss of the Universal Grammar, which is at hand to children. In order to clarify the age factor in second language acquisition, Felix (1985, as cited in Dong and Ren, 2013) developed a competition model, according to which, children's language learning is guided by a language-specific cognitive system, whereas adults apply their cognitive problem-solving system. These two systems compete. Newport (1990) defended the assumption *less is more*, which suggests that in case of early, natural exposure to a second language, investment of less conscious and cognitive efforts guarantees more success. Nevertheless, limited time and a need for structured learning (school environment) encourage adults and older children to learn more efficiently due to their explicit analytical skills. In terms of teaching efficiency, Moyer (2004) focuses on learning methods, having an emphasis on communication, since learners deem the same methods as being the most relevant, which is not the case with grammatical and translation exercises that lead to a delay of speech.

DeKeyser (2000) surveyed 57 English learners aged from 1 to 40 who were Hungarians and residents of the USA for 10 or more years. DeKeyser's test included 200 sentences; a few original sentences were deleted or amended while some supposedly difficult structures to the Hungarian examinees were added. Along with a grammatical assessment test, there was a linguistic competence test. This study was aimed at challenging the fundamental difference hypothesis (Bley-Vroman, 1988, as cited in Medved Krajnović, 2010). Similar to the research conducted by Johnson and Newport (1989),

DeKeyser's investigation did reveal significant correlations between the tests and variables such as length of stay, years of education or the age when the test was taken; there was only one negative correlation between the age and grammatically judgement tests. All children aged 16 or younger resolved correctly 180 out of 200 sentences (except a person who found solutions for only 170 sentences) while the score of most of the adult examinees (16 years of age or older) was below 180 points. However, it came to an overlap between these two groups; six examinees in the older groups had a relatively high score (above 175) and three of them exceeded the 180-point threshold. Such a score was derived, in DeKeyser's view, from the significant correlation between the results achieved at the grammatically judgement tests and the results accomplished at the general linguistic ability tests. The group with children aged 16 or less did not disclose any correlation between the grammatical competence and general linguistic ability. In other words, adult examinees with excellent results, similar to those of children who were exposed to the language at an early age, were characterized by a relatively high verbal-analytical competence, which facilitated their acquisition of the second language through an explicit overview of grammatical rules. In addition, DeKeyser's (2000) research showed that some structures are less prone to the age factor, which can be explained by means of perceptive prominence or in other words, the less prominent morphological structure, the less vulnerable it is to the age factor. Although DeKeyser's research is viewed as a consolidated version of Johnson and Newport's study (1989), it still involves certain flaws. One of them refers to the fact that the assertion that only adult learners with a high verbal competence can match children is not completely true since one out of three grown-ups did not have a high score at the general linguistic ability test. Likewise, since none of the native speakers served as a research control group, it is hard to compare the obtained results with native speakers' competence.

Hyltenstam and Abrahamson (2000) think that students who start learning a second language at an early age differentiate from native speakers and claim that there is no person who started learning a second language as a beginner and achieved the characteristics of native speakers regarding all linguistic aspects.

Today there are few scientists who deny the long-lasting advantage of children who start acquiring a second language as small children (Krashen, Long and Scarcella, 1979; Long, 1990). Yet, there are some discrepancies about the issue if this fact is to be explained by biological factors or limitations imposed on a learner together with maturational or socio-psychological factors. Most controversies on the issue of the critical period arise due to Lenneberg's (1967) original formulation of the critical period:

Automatic acquisition from mere exposure to a given language seems to disappear (after puberty), and foreign languages have to be taught and learned through a conscious and laboured effort. Foreign accents cannot be overcome easily after puberty. However, a person can learn to communicate at the age of forty. This does not trouble our basic hypothesis. (p. 176)

Indeed, the central place in the original formulation of the critical period is taken by the possibility of language acquisition up to the native speakers' level. Several scientists have lately stressed the fact that the hypothesis on the critical period and limitation of the maturational state relate to the capacity for language acquisition at the native speakers' level (Birdsong, 1999; Long, 1993 in Hyltenstam and Abrahamsson, 2003). Studies on the limitation of maturation or of the critical period have enticed the issues related to Lenneberg's fundamental concepts. At least three different theories which set ground for the researched issues can be considered. These are:

a) The first theory completely coincides with Lenneberg's theory and is focused on a language ability acquisition similar to that of native speakers, namely, simply through exposure to a second language. In this case, the hypothesis on the critical period should be regarded as groundless if this ability similar to native speakers' is found in learners, who start acquiring a language beyond a certain age limit, irrespective of the acquisition mode.

b) The second theory also deals with the respective age and ultimate language attainment and suggests that young learners outrank the older ones, which is witnessed by the final results with respect to ultimate attainment, even though older students sometimes reach the attainment level higher than that of the young ones under the same conditions.

c) According to the third theory, young learners are generally better at language acquisition than their older colleagues. The theory should be deemed as unfounded if older students are better than the young ones according to a success measurement in a particular area under the same learning conditions (Snow and Hoefnagel-Höhle, 1978 in Hyltenstam and Abrahamsson, 2003). While describing this theory, studies on ultimate attainment were neglected, which implies abilities similar to those of native speakers.

If acquisition of a second language vastly results from conscious efforts, i. e. learning in formal circumstances, the advantages of an early onset are either not recognized or it may be stated that they depend both on the age and many other factors (Nikolov 2009). Therefore, the ultimate success in foreign language learning is attributed to the interaction of a number of factors – motivational, interlingual, educational, generally cognitive and affective, e. g. a positive attitude towards all novelties and a low level of linguistic-cultural identity (Singleton 2001 in Medved Krajinović, 2010). Moyer (2004) also stressed that age is connected with socio-psychological factors such as motivation intensity, personal motivation, satisfaction with the achievement and personal fluency assessment. Later exposure to a language is characterized not only by stronger personal and professionally-oriented motivation but also by weaker satisfaction and lower fluency assessment and more intense aspiration to the native speakers' accent.

Hyltenstam and Abrahamsson (2003) substituted the concept of the critical or sensitive period for language acquisition with the concept of maturational period. They elaborated a model dealing with the role of the age of onset (AoA) of language acquisition, which reveals the interdependence of maturation factors, socio-psychological influences and the influence of practice. This involves the possibility of natural use of language and the possibility of conscious efforts of an individual to improve their own knowledge of a language. In compliance with these authors, maturational or neurological-cognitive factors have the key role in the successfulness of language acquisition all the way to adolescence, while later in life the major role is played by socio-psychological factors and the language practice. In addition, the authors think that the ability of language acquisition gradually declines immediately after the birth and that foreign language speakers, no matter if they started to acquire a language at an early or late stage of life, can never reach the native speakers' competence at all levels. Considering the importance given to maturational factors in language acquisition by the aforementioned authors, the role of the first language in second language acquisition is extremely important, since second language acquisition at later stages of life is hardly possible due to maturation limitation. Moyer (2004) investigated the role of age and maturation. The research results demonstrated that the age effects are not equally prominent during different ages of onset of the second language learning, i. e. around 15 years of age, other factors play an important role in language acquisition since certain neurological changes are stabilized in puberty.

There are a growing number of studies showing that even individuals who start acquiring a second language after puberty can also reach a very high level of linguistic and communication ability. The first of such studies was published by Coppieters (1987 in Hyltenstam and Abrahamsson, 2003) who gave syntactic and semantic assessment tests to 21 adult learners of French as a foreign language, followed by an oral interview. However, although the examinees were preliminarily characterized as native speakers and although they answered the questions related to syntactic-semantic assessment correctly, their general score did not match the score of native speakers since the recorded interviews discovered mistakes in the structures resolved in the assessment exercises. Birdsong (1992 in Hyltenstam and Abrahamsson, 2003) made a replica of Coppieters' research using strict criteria for selection of examinees and realized that 15 out of 20 examinees, i. e. learners who started learning French as a foreign language, accomplished the same score at demanding grammatically judgement tests as native speakers.

loup, Boustagui, El Tigi and Moselle (1994 in Hyltenstam and Abrahamsson 2003) observed Julie, a talented British woman who moved to Cairo at the age of 21 (she had never learned Arabic before), married an Arab man and worked as an English teacher at school. At the time of the research, she had lived in Cairo for 26 years. The same authors kept track of Laura, an exceptionally talented American who had learned Arabic at various universities and in various countries before coming to Cairo, and during the performance of the research had been married to an Egyptian for already 10 years. What makes this research different from other similar studies is an extremely large number of measuring instruments which involved some highly demanding tasks. The examiners rated the women's oral production, the ability of their differentiation of dialects and their grammatical competence (translation, grammatically judgement tests, anaphoric interpretation). The research disclosed that both Julie and Laura accomplished better results at dialect differentiation tests than some native speakers (Julie had somewhat better score than Laura did). At the oral production tests, both women were graded as native speakers by most examiners (native speakers of Arabic and teachers of Arabic as a foreign language) and at the grammatical intuition tests, both examinees achieved a high score (although slightly below that of native speakers). In other words, the differences between Julie and Laura and other native speakers were negligible. loup Boustagui, El Tigi and Moselle (1994 in Hyltenstam and Abrahamsson, 2003) assumed that if there are exceptions in the critical period, the

supposed neurocognitive differences do not occur in an ordinary way, although it is not clear if the usual acquisition manner keeps being functional or if there is an alternative system which substitutes the former.

Hyltenstam (1992 in Hyltenstam and Abrahamsson, 2003) examined the grammatical and lexical performance of 24 advanced examinees – Spanish and Finnish learners of Swedish aged 17-18 (their teachers did not immediately recognize them as non-native speakers). Out of 24 examinees, 16 of them started learning the second language when they were six years old or younger and 8 of them were eight years old or older. The examinees were bilingual and they actively used both languages. The group of 12 native Swedish speakers served as a control group and also participated in testing. The examinees were asked to orally retell four texts and to write an essay in Swedish. Even though the analysis of mistakes revealed their low frequency, the control group made 1-10 mistakes, the group of examinees who started learning the language at the age of six or earlier made 1-23 mistakes. In other words, the results of the 'older' group did not coincide with those of the native speaker group, whereas the results of the 'younger' group matched the results of both groups. Hyltenstam (1992 in Hyltenstam and Abrahamsson, 2003) concluded that the age of 6 to 7 is extremely important for differentiating the language acquisition of native speakers from the acquisition similar to that of native speakers. Considering that the group of younger students did achieve results similar to that of native speakers, it is assumed that an early age of onset may have a vital role in language acquisition although it is not a sufficient condition for the native speaker-like language acquisition.

Other studies on second language acquisition at an early age prove that there are differences between non-native speakers, who have almost reached the level of native speakers, and these differences referred to application of specific structures or to the scope and quality of vocabulary. The referring flaws are not immediately noticeable, but they can be traced in linguistic research results. Hene (1993 in Hyltenstam and Abrahamson, 2003) analysed several aspects of the vocabulary of 24 children aged 10-12 who were adopted by Swedish families at the age between three months and six years. The results revealed some differences in the comprehension of some frequent words and phrases, which appear in the curriculum and include local prepositions and lexical explanations expressed by synonyms and paraphrases.

Similar results were obtained by Butler (2000 in Hyltenstam and Abrahamsson, 2003). The author explored the knowledge of Chinese learners of English as a second language. The examinees were put into three groups (the first group – those who were first exposed to the language aged from 3 to 5, the second group – between 5 and 10, the third group – between 10 and 15) and there was one more group of native speakers. After applying a grammatically judgement test, it was concluded that the first group (those who got in touch with the language aged 3-5) achieved the best results, but these were still fairly below those of the native speakers. The first group was followed by the second group while the scores of the third group were the poorest (those who were exposed to language aged 5-10). Taking into consideration Butler's (2000, Ekberg, 1998; Hene, 1993 in Hyltenstam and Abrahamsson 2003), Hyltenstam's and Abrahamson's (2003) studies who explored second language acquisition, one can assume that they overlap with the studies on first language acquisition. It means that even the shortest delay in the age of onset does have an effect on ultimate attainment. Bearing in mind all the aforementioned, the outcome of the studies indicate that there is only a small number of learners who possess a potential for reaching the native speakers' level in one of the areas of the second language and such learners are deemed either highly motivated (Moyer, 1999 in Hyltenstam and Abrahamsson, 2003) or individuals with a high language learning ability (DeKeyser, 2000; Harley and Hart, 1997 in Hyltenstam and Abrahamsson, 2003).

Harley (1986) concluded that the successfulness of language acquisition is subject to a number of factors such as the level of cognitive maturity, motivation, exposure to a second language and the possibility of its active use, adding also that all these factors get into active interaction with the age of learners and obviously appear in connection with various levels of the language system. For instance, Harley emphasized that neurological factors, which do not have to be necessarily bound to language, but they can be more general such as the aging process in which it comes to decrease and deterioration of numerous neuron connections in the network of the brain nervous system, contribute to a diminished ability of all forms of learning and hence the language.

Besides the critical period, there are four types of factors which might be responsible for the impact of the age of onset of language learning. These are motivational, linguistic, educational and general cognitive factors (Singleton and Ryan, 2004). Motivational factors are linked with the issue of language domination. Late comers to the second language environment frequently come into contact with their mother tongue and accordingly, restrain their contacts with the second language, which can be interpreted by their wish for avoiding isolation and/or the wish for retaining a particular language-cultural identity. On the other hand, the children's affective filter is lower or in other words, a child's feelings towards everything

related to second language acquisition are more positive than the feelings of adults and thus become a smaller drawback to acquisition of new information, knowledge and skills.

Regarding the linguistic factors, the time spent in the country where the target language is in use and the time spent with native speakers, have turned out to be the main determinant of the pronunciation quality of a second language (Riney and Flege, 1998 in Singleton and Ryan, 2004).

As far as the educational dimension is concerned, Bialystok and Hakuta (1999 in Hyltenstam and Abrahamsson, 2003) suggested that existence or a lack of second language writing skills can appear as a basis for second language competence and observed that immigrants who migrate at a young age have mostly well-developed writing skills – due to their schooling experience – while those who migrate as late comers do not have such a good opportunity to develop these skills.

Finally, in terms of the cognitive factors, Bialystok and Hakuta (1999 in Hyltenstam and Abrahamsson, 2003) stressed a regression in areas such as task completion under pressure, taking risks, establishment of long-term memory codes and the ability of memorizing details.

Taking into account the age of onset and ultimate attainment, the previous results might be summed up in the following way:

a) The native speakers' competence can only be attained by early learners, which is shown in Figure 1.

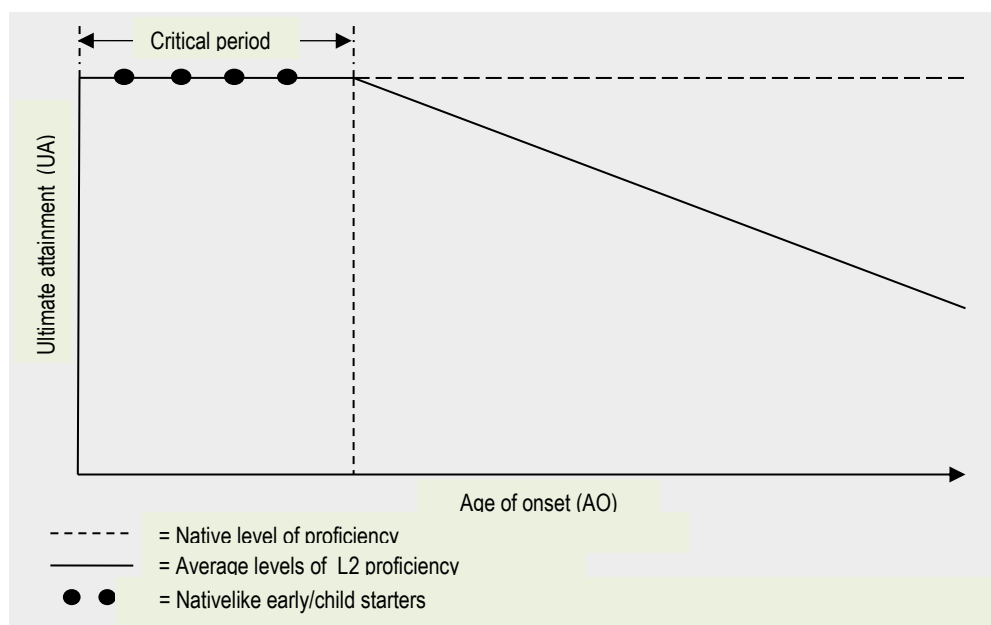


Figure 1. Observations of nativelike ultimate attainment in early starters only "Maturational Constraints in SLA" by K. Hyltenstam and N. Abrahamsson, 2003, p. 567. From *The Handbook of Second Language Acquisition* by Long, M. H. , 2003, Oxford, UK: Blackwell Publishing Ltd.

These data are based on the studies which suggest that the average attainment of young learners is similar to that of native speakers and that it negatively correlates with the age (Johnson and Newport, 1989; Patkowski, 1990 in Hyltenstam and Abrahamsson, 2003). The above results are explained by the biological effects of the critical period theory (DeKeyser, 2000; Johnson and Newport, 1989; Patkowski, 1990 in Hyltenstam and Abrahamsson, 2003). The alternative interpretation attributes it to identity, motivation, input, cognition, formal learning and other social conditions.

b) The native speakers' competence can be attained by early learners and by only few late learners as shown in Figure 2.

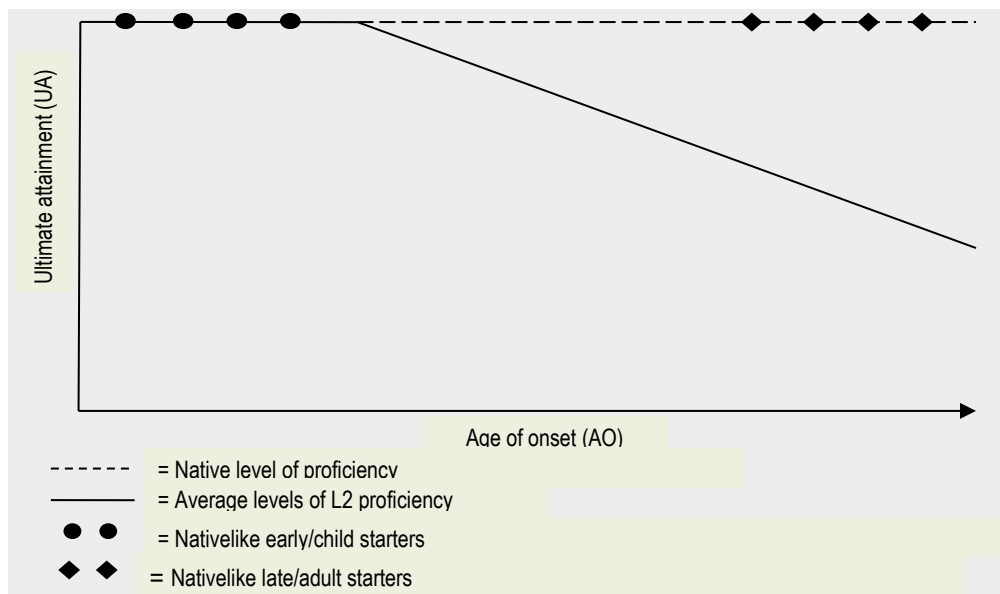


Figure 2. Observations of nativelike ultimate attainment in early starters and individual late starters. "Maturational Constraints in SLA" by K. Hyltenstam and N. Abrahamsson, 2003, p. 568. From *The Handbook of Second Language Acquisition* by Long, M. H. , 2003, Oxford, UK: Blackwell Publishing Ltd.

This theory is based on the research proving that there are exceptionally successful students who started learning a language late in life, but managed to reach the native speakers' level (Birdsong, 1992; Bongaerts, 1999; Moyer, 1999; White and Genesee, 1996 in Hyltenstam and Abrahamsson, 2003). The first explanation of this theory is that there is no biologically dependent critical period and that learners of any age can reach the native speakers' level (Birdsong, 1992; White and Genesee, 1996 in Hyltenstam and Abrahamsson, 2003). The second explanation says that despite the existence of a biologically dependent critical period, there are some late learners who can exceed the expectations of the critical period hypothesis compensating their late age of onset with a great talent (DeKeyser, 2000; Ioup et al, 1994 in Hyltenstam and Abrahamsson, 2003), high motivation (Bongaerts, 1999, 2000; Moyer, 1999 in Hyltenstam and Abrahamsson, 2003), formal education and input (Bongaerts, 1999 in Hyltenstam and Abrahamsson, 2003).

c) The native speakers' competence can be attained neither by early nor by late learners as shown in Figure 3.



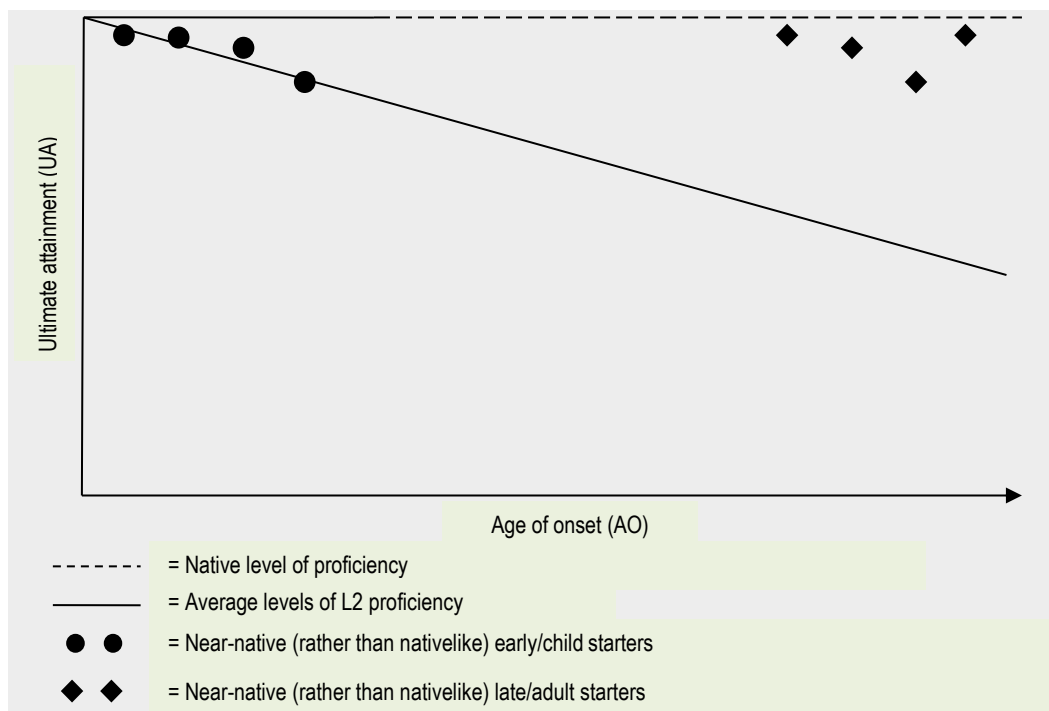


Figure 3. A reassessment of the nativelikeness of both early and late starters. "Maturational Constraints in SLA" by K. Hyltenstam and N. Abrahamsson, 2003, p. 569. From *The Handbook of Second Language Acquisition* by Long, M. H. , 2003, Oxford, UK: Blackwell Publishing Ltd.

This theory is based on evidences which prove that even early learners cannot match native speakers (Ekberg, 1998; Hene, 1993; Hyltenstam, 1992; Hyltenstam and Abrahamsson, in print, McDonald, 2000 in Hyltenstam and Abrahamsson, 2003), that the ultimate attainment of some extremely successful older learners shown in Figure 3 is not identical in all relevant aspects to that of native speakers (Coppieries, 1987; Ioup et al, 1994; Moyer, 1999; White and Genesee, 1996 in Hyltenstam and Abrahamsson, 2003) or that ultimate attainment declines linearly (not suddenly) with age (Bialystok and Hakuta, 1999; Birdsong, 1999; Butler, 2000; Flege, 1999; Guion et al, 2000 in Hyltenstam and Abrahamsson, 2003). The first interpretation of this theory is that the possibility of second language ultimate attainment linearly declines already from the birth (Hyltenstam and Abrahamsson, 2003; Birdsong, 1999) and the second one suggests that the declined language skills result from a linear decline of all the skills in general (Bialystok and Hakuta, 1999 in Hyltenstam and Abrahamsson, 2003).

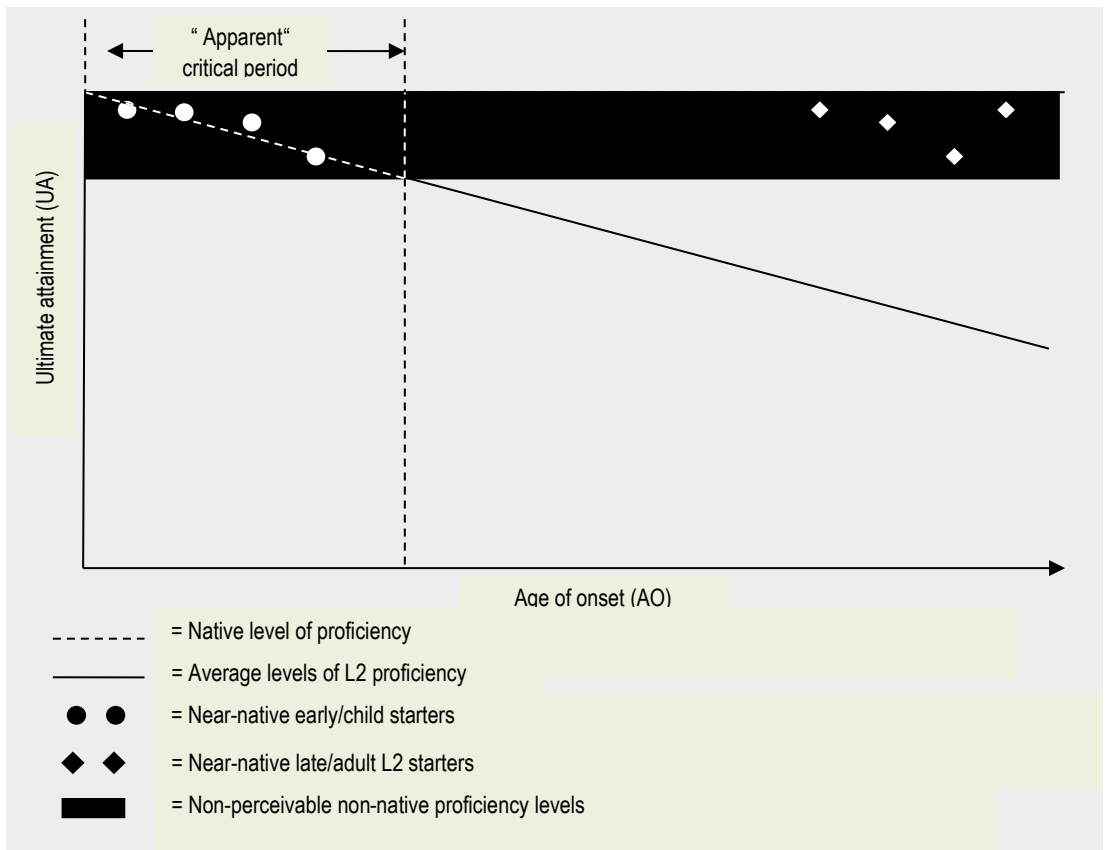


Figure 4. A reinterpretation of nativelikeness as non-perceivable non-nativeness, and the critical period as an "illusion" based on data from underanalyzed early starters. "Maturational Constraints in SLA" by K. Hyltenstam and N. Abrahamsson, 2003, p. 572. From *The Handbook of Second Language Acquisition* by Long, M. H., 2003, Oxford, UK: Blackwell Publishing Ltd.

Figure 4 encompasses all the previous theories and figures denoted by numbers 1, 2 and 3. The Figure 4 makes it clear that the examinees qualified as native speakers do not actually exist, i. e. the examinees identified as native speakers, who start learning a language early or some late learners, who were regarded as native speakers, are actually very close to the native speakers' level but not really on it. What is thought to be a critical period is nothing else but the time preceding the age of onset, whereas the ultimate attainment of average learners of a second language is claimed not to be on the native speakers' level.

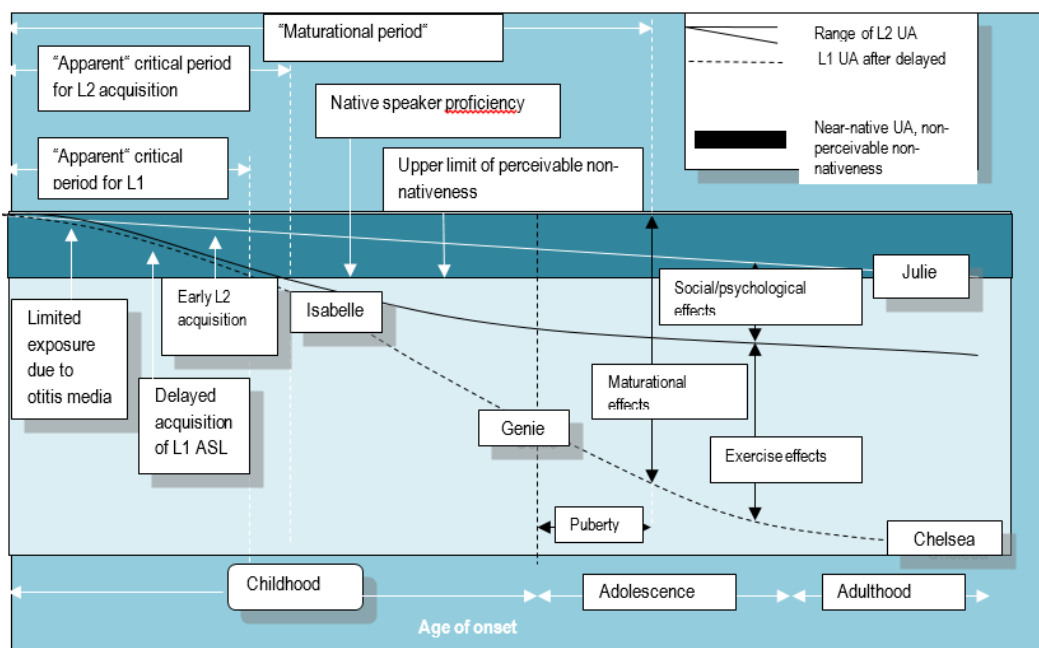


Figure 5. A model of the interplay between maturation, exercise, and social/psychological factors. "Maturational Constraints in SLA" by K. Hyltenstam and N. Abrahamsson, 2003, p. 573. From *The Handbook of Second Language Acquisition* by Long, M. H. , 2003, Oxford, UK: Blackwell Publishing Ltd.

Figure 5 actually presents a consensus model, the purpose of which is to integrate the existing empirical facts and various theories. Although maturation plays an important role in language acquisition, other factors also contribute to the ultimate attainment of some individuals. Figure 5 shows a possible scope of attainment levels which range from zero (bottom of the diagram) to ultimate attainment (on top). The black bold line in Figure 5 presents an attainment level similar to that of native speakers and the upper curve shows the ultimate outcome of some exceptionally successful individuals (Julie). The lower solid line presents the final achievement of students who cannot be regarded as successful students. The space between the two curves presents the range of the achieved attainment levels. The dotted curve presents the delayed attainment of the first language. Although cases of first language delayed attainment are rare, they still clearly show that the previously established system of first language delayed attainment influences second language attainment. The difference between the level of attainment of the native speakers and a low level of first language attainment is a reflection of the maturational effect, i. e. maturation can explain the general and linear decline of language acquisition, which rises with an increasing age of onset while the difference between exceptionally successful and unsuccessful learners with the same age of onset cannot be interpreted by maturation. In other words, socio-psychological factors can clarify the reasons why a learner who starts learning a language at the age of 25 is able to reach a higher level of attainment than another learner of the same age, but these factors cannot explain the reasons why a child who starts learning a language at the age of four has a better score than the older learner. The latter explanation can be provided only by maturational factors. It seems that the role of socio-psychological factors becomes extremely important later in life. At the age of six or seven, all the learners automatically attain levels which make them eligible to appear as native speakers – under the condition that there is a sufficient input and after that, socio-psychological factors have to be extremely favourable to compensate for the negative impacts of maturation.

Figure 5, similar to Figure 4, does not involve curves that reach the peak of the diagram; ultimate attainment cannot be achieved even if started only slightly later. Taking into account the fact that there are no proofs that any adult learner can match native speakers at all levels and considering the fact that early learners cannot catch up with native speakers either, one can draw the conclusion that complete second language mastering is not possible.

Finally, the term maturational period itself (period between the birth and the 15<sup>th</sup> year of life) is used instead of the term critical/sensitive/optimal period. The continuous decline of all the curves after the age of 15 can be interpreted as something that does not depend on maturational factors. Ultimate attainment depends on the level of motivation, talent and other potentials of a person which cannot be anticipated based on the age of onset. On the other hand, the critical period, based on attainment native speaker-like levels can be predicted if the attainment commences within the critical period. Figure 4 focuses on the importance of time periods which can be understood as critical periods. The bottom of the black bold line in Figure 5 is at the end interrupted (firstly by the curve that represents the first language and then by the lower curve that represents the second language). If the bottom of the line representing the native speaker-like attainment is interpreted as an ultimate attainment, identical to that of native speakers, it can be concluded that there are obvious critical periods within which a high level attainment similar to that of native speakers can be realized. Still, there is a pending question where (or how) the upper curve representing the second language passes the limit of the level which is below the native speakers' level. In line with the aforementioned, some studies dealing with the issue of the critical period can be challenged, even though there are evidences of the role of maturation in the first and second language acquisition.

## Conclusion

There are few scientists today who deny the long-lasting advantage of children who start acquiring a second language as early starters. However, some discrepancies appear regarding the issue if this fact is to be explained by biological factors or limitations imposed on a learner together with maturational or socio-psychological factors.

If acquisition of a second language vastly results from conscious efforts, namely, from learning in formal circumstances, the advantages of an early onset are either not recognized or are dependent both on the age and many other factors. Therefore, the ultimate success in second language learning is attributed to the interaction of a number of factors – motivational, interlingual, educational, cognitive and affective, satisfaction with the achievement, and a positive attitude towards all novelties.

## References

- Birdsong, D. (1999). *Second Language Acquisition and the Critical Period Hypothesis*. Mahwah, NJ: Lawrence Erlbaum Associates, Inc.
- DeKeyser, R. M. (2000). The robustness of critical period effects in second language acquisition. *SSLA*, 22, 499-533.
- Dimroth, C. (2008). Age Effects on the Process of L2 Acquisition? Evidence from the Acquisition of Negation and Finiteness in L2 German. *Language Learning*, 58 (1), 117-150.
- Dong, G. & Ren, H. (2013). The Role of Age in Second Language Acquisition – A Psychological Perspective. *British Journal of English Linguistics*, 1 (1), 1-6.
- Harley, B. (1986). *Age in Second Language Acquisition*. Clevedon: Multilingual Matters Ltd.
- Hyltenstam, K. & Abrahamsson, N. (2000). Who can become native-like in a second language? All, some, or none? On the maturational constraints controversy in second language acquisition. *Studia Linguistica*, 54 (2), 150-166.
- Hyltenstam, K. & Abrahamsson, N. (2003). Maturational Constraints in SLA. In Doughty, C. J. & Long, M. H. (Eds. ), *The Handbook of Second Language Acquisition*. pp. 539-588. Oxford, UK: Blackwell Publishing Ltd.
- Hyltenstam, K. & Abrahamsson, N. (in print): Age of onset and ultimate attainment in near-native speakers of Swedish. In Doughty, C. J. & Long, M. H. (Eds. ), *The Handbook of Second Language Acquisition*. Oxford, UK: Blackwell Publishing Ltd.
- Johnson, J. S. , & Newport, E. L. (1989). Critical Period effects in second language learning: the influence of maturational state on the acquisition of English as a second language. *Cognitive Psychology*, 21 (1), 60-99.
- Krashen, S. , Long, M. H. & Scarcella, R. (1979). Age, rate and eventual attainment in second language acquisition. *TESOL Quarterly*. 13 (4), 573-82.

- 
- Lenneberg, E. H. (1967). *Biological Foundations of Language*. New York: Wiley.
- Medved Krajnović, M. (2010). *Od jednojezičnosti do višejezičnosti*. Zagreb: Leykam international.
- Moyer, A. (2004). *Age, Accent and Experience in Second Language Acquisition*. Clevedon, Buffalo, Toronto: Multilingual Matters.
- Newport, E. L. (1990). Maturation constraints on language learning. *Cognitive Science*, 14 (1), 11-28.
- Nikolov, M. (2009). *Early Learning of Modern Foreign Languages: Processes and Outcomes*. Bristol/Buffalo/Toronto: Multilingual Matters.
- Singleton, D. (1989). *Language Acquisition: the Age Factor*. Clevedon, Avon: Multilingual Matters.
- Singleton, D. (2005). The critical period hypothesis: A coat of many colours. *International Review of Applied Linguistics*, 43, 269-286.
- Singleton, D. & Ryan, L. (2004). *Language Acquisition. The Age Factor*. 2nd edition. Clevedon, Buffalo, Toronto: Multilingual Matters Ltd.

## Pedagogical Content Knowledge among the Teachers of Special Classes of Reading and Memorizing the Qur'an (KKQ) in Kuala Lumpur.

Aznil Hashim

Faculty of Human and Science, Sultan Idris University of Education

[aznil@fsk.upsi.edu.my](mailto:aznil@fsk.upsi.edu.my)

### Abstract

*This study aims to examine the level of pedagogical content knowledge among the teachers of Special Classes of Reading and Memorizing the Qur'an (KKQ) in teaching the Quranic Tajweed in the Federal Territory of Kuala Lumpur. The implementation of this study involves two groups of respondents, i. e. the group of teachers and the students of KKQ. Data from both groups of respondents were collected using two sets of questionnaires developed by the researchers. Content validity of the questionnaires was conducted by setting up an expert reference panel. Cronbach's alpha reliability values for all parts of the questionnaire were high ( $> 0.9$ ). Quantitative data were analyzed by descriptive and inferential using IBM SPSS V20 to obtain the frequency, percentage, mean, standard deviation, differences and correlations. Overall, KKQ teachers found to have high level of pedagogical content knowledge in the Quranic Tajweed lessons. The difference analysis showed that significant difference exist on the level of pedagogical content knowledge of KKQ teachers in demographic aspect based on their university background and teaching experience. Meanwhile, correlation analysis found that there was a significant relationship between teachers' pedagogical content knowledge and the student achievement in the Quranic Tajweed lessons of KKQ. The positive findings on the level of knowledge of the contents should be maintained or increased from time to time, as well as identified differences factors should be handled systematically, whereas those aspects that are found to have a relationship with the educational achievements of recitation of the Qur'an must be improved.*

### INTRODUCTION

Teaching is a process of transmission of knowledge from teacher to student. This process typically involves a variety of activities such as planning, implementation, evaluation and feedback (Shahabuddin, Rohizani & Mohd. Zohir, 2003). It should be planned properly (Mohd Yusuf, 2000) to produce effective teaching thus be able to establish effective learning in the classroom (Al-Shaibani, 1991).

As Muslims, we believe that the Prophet Muhammad P.U.B.H is the greatest teacher and educator of all time (Abdul Fattah, 2011). The process of teachings undertaken by him easily understood by the mind and gives an impact to the heart of every student. He did not have one specific method and technique that can be applied in every teaching rather it depends on the reality of student that has been taught (Mohd Yusuf, 2004). This approach makes it easier for students to accept and understand the knowledge presented by him. Furthermore, a good value or a thing for an individual does not necessarily give a good impression if applied to other individuals (Yusuf Al-Qardhawi, 2003)

Among the important factors that are often considered by him in the teaching is the pedagogical content knowledge factor to ensure the teaching session runs smoothly and effectively (Abdul Fattah, 2011). This approach has been demonstrated by his exemplary, mainly because he is a good example in all aspects, including in the methods of teaching (Ibrahim Mamat, 1997).

### RESEARCH BACKGROUND

The existence of Quranic Tajweed learning as one of the most important components in KKQ classes was aims to give students the exposure to the various methods of controlling the letters and verses of Qur'an in accordance with the rules of recitation. Students who mastered this skill will be able to read the Qur'an correctly according to the methods and procedures which should be read (JAPIM, 2005). The teaching of the Qur'an recitation should be implemented in the form of instruction, demonstration and student errors fixing (Shahabuddin, Rohizani & Mohd. Zohir, 2003) since this lesson exists

in the form of skills (Ministry of Education, 2004). The effectiveness of teaching in this subject depends on the level of pedagogical content knowledge possessed by teachers of KKQ themselves. Therefore, KKQ teachers need to prepare with the content of the subjects taught and are aware of the reality of students, as well as proficient in adapting a form of pedagogy in accordance with the level of content and the condition of the students of KKQ (Shulman, 1987).

The implementation of KKQ had spanned for 27 years and continues to face various weaknesses and shortcomings in terms of knowledge content of Qur'an recitation among teachers of KKQ. The result findings show this weakness is not limited to the Religious Stream Classes (KAA) but also applies to all schools in Malaysia that has KKQ (Aderi, 2011). The role of the Qur'an is important for all Muslims in reality that this should not have happened. The KKQ teaching system of the Quranic Tajweed particularly, needs to be improved to enhance the students' proficiency of the knowledge of Quran. Definitely that one of the methods to achieve this is by increasing the pedagogical content knowledge of KKQ teachers in the Quranic Tajweed learning.

## PROBLEM STATEMENT

The understanding of students in the Quranic Tajweed is closely related to the level of pedagogical content knowledge of KKQ teachers for this subject. This is because the effective teaching of a subject depends on some knowledge including the pedagogical knowledge (Gudmundsdottir, 1990). Proficiency of this knowledge allows the teachers to shape the development of the students' knowledge including the Quranic Tajweed (Magnusson et al. , 1994). The existence of pedagogical content knowledge is one of the most important components of teachings and is generally known by teachers but most were found to have poor possession of this knowledge (Verloop & Vos, 1998).

Usually, KKQ teachers face problems related to pedagogical content knowledge in teaching Qur'an Tajweed as they do not have the training or the exposure to enhance the knowledge (Mohd. Safwan, 2007; Eadil, 2010). As a result, there are some teachers do not skill in the content of Quranic Tajweed (Islamic and Moral Education Department, 2005). This problem can be seen through the presence of a number of teachers who do not perform teaching in line with the objective of KKQ teaching including in the actual Qur'an recitation (Mohd. Safwan, 2007). This negative practice causes the objectives of Qur'an recitation is not reached (Ahmad Sahli, 2008).

Preliminary studies show that teachers who lack in mastering the pedagogical content knowledge affect the way of teaching in the classroom. They are bound to teach briefly (Akmariah & Sofiah, 2010) and more likely to use traditional teaching methods which often leads to the limited usage of educational resources (Dorahim & Ab. Halim, 2011). This negative tendency usually affects the interest of students toward the Quranic Tajweed learning in KKQ. Students will feel bored, less active and passive attitude towards the teaching carried. As a result, the teaching process takes place in a bland and uninteresting surrounding in which it offers a direct negative impact on the effectiveness of teaching and the students' attainment in KKQ subject, including in the lessons of recitation of the Quranic Tajweed (Islamic and Moral Education Department, 2005).

## RESEARCH OBJECTIVES

This study specifically aims to achieve the outlined objectives as follows:

- i. To determine the level of KKQ teachers' pedagogical content knowledge in teaching recitation of the Quran.
- ii. To identify the different levels of pedagogical content knowledge of KKQ teachers by the following demographic aspects such as:
  - a) Gender
  - b) The background of the university
  - c) Sanad Certificate (*Sanad*)
  - d) Location of school
  - e) Teaching experience

- iii. To identify the correlations between the level of pedagogical content knowledge with the achievement of Quranic Tajweed among the students of KKQ.

## RESEARCH METHODOLOGY

### Research Design

This research was a quantitative study in the form of descriptive and inferential using the survey method as a method of data collection. The survey method was used as the data collected by using this method are frequently accurate (Kerlinger, 1986) and can be used to collect data from a large group of subjects such as teacher and student (Ary, 2002). The questionnaires used in this study are selected results as it contains questions or statements that come in together with the proposed stimulus and response answers (Mohd. Majid, 2005). The researchers used a five point *Likert* scale responses of respondents to every statement contained in the questionnaire to collect data. This scale is suitable to measure the views expressed by respondents in a particular area on an ongoing basis about a perceptions practice and behaviours (Cohen et al. , 2000). To answer the questionnaire is by checking one of the numbers from 1 to 5, based on the evidence in each of these numbers, i. e. ; Strongly Disagree is given a score of 1 to Strongly Agree given a score of 5.

### Validity and Reliability

The validity of the questionnaire instruments content was determined by establishing an expert reference panel. They consist of four qualified individuals who have expertise in the field of Islamic education, an expert in the field of research and experience in the field of education of the Qur'an to ensure content validity and face validity. The reliability of the research instrument refers to the internal consistency of the items used in the instrument (Gall, Gall & Borg, 2005). In the context of this study, the internal consistency of each instrument item was obtained by using Cronbach's alpha coefficient. Results of the analysis indicate that all the instruments in this study have the high reliability (> 0. 90). Thus, these instruments can be used in the actual study.

Table 1

#### *Reliability Index Classification*

Indicator	Cronbach's alpha value
Very High	0. 90-1. 00
High	0. 70-0. 89
Moderate	0. 30-0. 69
Low	0. 00-0. 30

Source: Brymen & Cramer (1999)

### Research Respondents

This study was conducted on teachers and the Form Four students of KKQ in 17 Religious Stream Classes (KAA) schools in Kuala Lumpur. The study population consists of 18 teachers, covering the entire 17 KAA schools in Kuala Lumpur. The



population of students is 180 students, applied only on schools with Form Four KKQ students in six KAA schools. The sampling method for teachers are calculated using the entire population (Mohamad Najib, 1999) while for the sample of students; Krejcie and Morgan method (1970) is used with a count of each sample were 18 teachers and 123 students. For the sampling of teachers, studies were carried out in Putrajaya and Selangor to meet the criteria of quantitative research which was more than 30 samples (Hishamuddin, 2005). To avoid such errors of incomplete questionnaires or were not returned, the researchers determined the number of samples for teachers and their students amounted to 50 teachers and 150 students. The final numbers of respondents involved in this study were 43 teachers and 134 students.

The quantitative data analysis in this study was performed by descriptive and inferentially using the IBM SPSS V20 software. Descriptive analysis is described by using the tables of effective behavioural mean interpretation by Nunally (1978) as shown in Table 2.

Table 2

*Interpretation Mean of Effective Behavioural Dimensions*

Mean score	Interpretation
4. 01-5. 00	High
3. 01-4. 00	Moderately High
2. 01-3. 00	Moderately Low
1. 01-2. 00	Low

Source: Stufflebeam (1971)

Inferential statistical analysis was used to obtain statistical inference from a sample of the entire population. In the context of this study, inferential analysis was conducted based on the procedures of *Independent-Samples T Test* and *One-Way ANOVA* to test the significance level for the mean score comparison of the independent variable i. e. teachers demographic. Meanwhile, the correlation analysis was conducted using *Bivariate Correlations* procedures to measure the strength of correlation between the used dependent variable. In the context of this study, *Spearman (r)* correlation model was used because the data is not distributed normally.

Table 3

*The Correlation Coefficient Value*

The Correlation Coefficient Value (r)	Interpretation
1. 00	Perfect
0. 70-0. 99	Very High
0. 50-0. 69	Strong
0. 30-0. 49	Moderate
0. 10-0. 29	Low

0. 01-0. 09

Negligible

Source: Davies (1971)

**RESEARCH FINDINGS****KKQ Teachers' Profiles**

Based on Table 4 below, it was found that a total of 43 teachers were involved in this study. The details number based on gender ratio indicates that respondents of male teachers (26 males = 60. 5%) were more than female respondents (17 females = 39. 5%). From the aspect of universities background it shows that the teacher respondents' which graduated from the local universities (29 people = 67%) was more than the number of teacher respondents' that graduated from foreign universities (14 people = 32. 6%). In the aspect of *sanad* certificate, the number of respondents who have *sanad* certificate (11 people = 25. 6%) was less than the number of respondents who did not have the *sanad* certificate (32 = 74. 4%). The finding from the teaching experience aspect was found out to be more balanced. The respondents from among the experienced teachers who teach more than 10 years amounted to 14 people (32. 6%). While the respondents of teachers who has 5-10 years of teaching experience was 15 people (34. 9%). This amount was not that much of a difference from the number of respondents who has teaching experienced in a period of 1-5 years, i. e. 14 people (32. 6%).

Table 4

*KKQ Teachers' Profiles*

Items		Frequency	Percentage
Gender	Male	26	60. 5%
	Female	17	39. 5%
University background	Local	29	67. 4%
	Abroad	14	32. 6%
<i>Sanad</i> Certificate	Yes	11	25. 6%
	None	32	74. 4%
School location	City	25	58. 1%
	Rural	18	41. 9%
Teaching experience	More than 10 Years	14	32. 6%
	5-10 Years	15	34. 9%
	1-5 Years	14	32. 6%

### KKQ Students' Profiles

In this study, KKQ students' profile was limited to only one aspect which was gender as this was the only aspect involved in the implementation of the study. The data for KKQ students' profile can be referred in Table 5 below. The findings showed that the number of respondents among the male students (64 people = 47.8%) was less than the number of female students (70 people = 52.2%). This shows that most respondents involved in this study were the female students.

Table 5

#### KKQ Students' Profiles

Items		Frequency	Percentage
Gender	Male	64	47.8%
	Female	70	52.2%

### Pedagogical Content Knowledge Level of KKQ Teacher's in Quranic Tajweed Teaching

Table 6 represents the mean, standard deviation and interpretation for each constructs of KKQ teachers' pedagogical content knowledge in teaching Quranic Tajweed based on the perception of them. The total mean score of constructs was 4: 44, standard deviation was 0: 39 and the interpretations were high. The highest mean earning is the construct of the readiness of teachers (mean = 4.61, sd = 0.39), followed by the construct of perception of KKQ (mean = 4.59, sd = 0.52). The constructs of knowledge and syllabus content (mean = 4: 52, sd = 0.47), followed by constructs of other knowledge and related disciplines (mean = 4.49, sd = 0.46), syntactic knowledge (mean = 4: 37, sd = 0.50) and the lowest is the constructs of substantive knowledge (mean = 4.36, sd = 0.50).

The total mean score for the pedagogical content knowledge constructs based on student perceptions was 4.65, the standard deviation was 0.21 and the interpretation was at high level. Construct with the highest mean score value was the construct of the readiness of teachers (mean = 4.70, sd = 0.35), followed by the construct of pedagogical content knowledge and the syllabus (mean = 4.69, sd = 0.32). Next is the perception construct of KKQ (mean = 4.67, sd = 0.32), substantive knowledge (mean = 4.67, sd = 0.34), syntactic knowledge (mean = 4.65, sd = 0.35) and the construct with the value of the lowest mean score is the construct of mastery in other relevant discipline (mean = 4.63, sd = 0.33).

Table 6

#### Pedagogical Content Knowledge Level Based on Perception of Teachers and Students

Pedagogical Content Knowledge	Teachers' Perceptions			Students' Perceptions		
	Mean	S. D	Interpretation	Mean	S. D	Interpretation
Teacher readiness	4.61	0.39	High	4.70	0.35	High
Perception towards KKQ	4.59	0.52	High	4.67	0.32	High

Substantive knowledge	4.36	0.50	High	4.67	0.34	High
Syntactic knowledge	4.37	0.50	High	4.65	0.35	High
Mastery in content knowledge and syllabus	4.52	0.47	High	4.69	0.32	High
Mastery of other relevant discipline	4.49	0.46	High	4.63	0.33	High
<b>Total Mean</b>	<b>4.44</b>	<b>0.39</b>	<b>High</b>	<b>4.65</b>	<b>0.21</b>	<b>High</b>

### Mean Score Differences of Pedagogical Content Knowledge Level Based on Teachers' Demographic

The T-test analysis results in Table 7 below shows that there is no significant difference in mean scores ( $P = 0.241$ ,  $p > 0.05$ ) of KKQ teachers' pedagogical content knowledge based on male gender ratio (min = 4.580, sd = 0.337) and female (mean = 4.353, sd = 0.427). There was also no significant difference of the mean score ( $P = 0.116$ ,  $p > 0.05$ ) in the aspects of *sanad* certificate that is exist (mean = 4.633, sd = 0.306) compared with none (mean = 4.441, sd = 0.404). However, the t-test analysis from the aspect of universities background found the difference in mean scores were significant ( $P = 0.054$ ,  $p < 0.05$ ) among the KKQ teachers' pedagogical content knowledge based on the educational background from the local university (mean = 4.494, sd = 0.426) with the foreign universities (min = 4.482, sd = 0.303). Next, the t-test analysis based on the school location showed that there is no significant difference in mean score ( $P = 0.626$ ,  $p > 0.05$ ) between cities (mean = 4.515, sd = 4.456) and rural areas (mean = 4.456, sd = 0.397).

Table 7

*T-test for Differences Level of PCK Based on Demographic*

Teachers' Demography	N	Mean	SD	t Value	Sig. P
<b>Gender</b>					
Male	26	4.580	0.337	1.945	0.241
Female	17	4.353	0.427	1.850	
<b>Universities background</b>					
Local	29	4.494	0.426	0.095	0.054*
Abroad	14	4.482	0.303	0.107	
<b>Sanad certificate</b>					
Yes	11	4.633	0.306	1.432	0.116
None	32	4.441	0.404	1.641	

**School Location**

City	25	4.515	0.385	0.489	0.626
Rural	18	4.456	0.397	0.487	

\*Significant at the level of  $p < 0.05$

The results of one-way analysis of variance in Table 8 below shows a significant mean difference ( $P = 0.050$ ,  $p < 0.05$ ) on KKQ teachers' pedagogical content knowledge based on the aspects of teaching experience. Further, post-hoc Scheffe test was carried out to identify the differences between the scores of different groups of teaching experience. The test results are shown in Table 8.

Table 8

*One Way ANOVA Level of PCK Based on Teaching Experience*

	JKD	DK	MKD	F	Sig. P
Among Groups	0.876	2	0.438	3.240	0.050*
In Group	5.405	40	0.135		
Total	6.281	42			

\*Significant at the level of  $p < 0.05$

The results of post-hoc Scheffe test as in Table 9 below indicates that there is a significant difference in mean scores ( $P = 0.050$ ,  $p < 0.05$ ) in pedagogical content knowledge of the teachers with more than 10 years teaching experienced (mean = 4.673,  $sd = 0.280$ ) with experienced teachers teaching within the period of 1-5 years (mean = 4.325,  $sd = 0.370$ ).

Table 9

*Scheffe Post Hoc Test Level of PCK Based on Teaching Experience*

Teachers' Demography	N	Mean	More than 10 years	5-10 Years	1-5 Years
More than 10 years	14	4.673		0.410	0.050*
5-10 Years	14	4.485	0.410		0.509
1-5 Years	15	4.325	0.050*	0.509	

\*Significant at the level of  $p < 0.05$

**Correlation between Teachers Pedagogical Content Knowledge with Students' Quranic Tajweed Achievement**

Table 10 shows the Spearman correlation analysis ( $r$ ) between teachers' pedagogical content knowledge and Quranic Tajweed achievement of KKQ students. The results show that there is a significant relationship between the four constructs of pedagogical content knowledge with the achievement of Quranic Tajweed of KKQ students. These construct are teachers' readiness ( $r = 0.190, p < 0.05$ ), substantive knowledge ( $r = 0.290, p < 0.05$ ), syntactic knowledge ( $r = 0.236, p < 0.05$ ) and mastery of other relevant discipline ( $r = 0.292, p < 0.05$ ). There are two constructs that do not show a significant relationship with the achievement of Quranic Tajweed, i. e. student's perception towards KKQ ( $r = 0.253, p > 0.05$ ) and the acquisition of knowledge and syllabus content ( $r = 0.236, p > 0.05$ ). As a whole, there is a significant relationship between content knowledge on lower levels ( $r = 0.221, p < 0.05$ ) and the achievement of the Quranic Tajweed recitation among KKQ students.

Table 10

*The Correlation between Content Knowledge Pedagogical with Students' Quranic Tajweed achievement*

	$r$	Sig. P
Teacher readiness * Student's achievement	0.190	0.028*
Perception towards KKQ * Student's achievement	0.253	0.100
Substantive knowledge * Student's achievement	0.290	0.001*
Syntactic knowledge * Student's achievement	0.236	0.006*
Mastery in content knowledge and syllabus * Student's achievement	0.260	0.098
Mastery of other relevant discipline * Student's achievement	0.292	0.001*
<b>Content knowledge * Student's achievement</b>	<b>0.221</b>	<b>0.017</b>

\*\* Correlation is significant at the level of  $p < 0.05$  (two-tailed)

N=134

## DISCUSSION

### KKQ Teachers' Level of Content Knowledge in Teaching Quranic Tajweed

The research findings show that teachers of KKQ have a high level of preparedness of teaching the Quranic Tajweed. It is clear through the acquisition mean scores for both groups of respondents, where; teachers and students was at a high level respectively (mean = 4.61, sd = 0.39) and (mean = 4.67, sd = 0.36). This show, teachers of KKQ have become proficient in theoretical background and have a deep understanding of education as well as able to identify the behaviour of students in the classroom of Quranic Tajweed (Abdul Halim, 1999). Apart from improving students' understanding of the Quranic Tajweed lessons, this knowledge is also important as a consideration factor in the teachers' planning process of teaching (Fraser, 1990).

Teachers of KKQ also found to have a good perception of the lessons that is included in the subject of the Quranic Tajweed. This finding also indicates that teachers of KKQ are capable in delivering content of Quranic Tajweed lessons effectively and easily understood by students (Davis & Newstrom, 1985). At the same time, they are clear about the outlined objectives of the subject and have high awareness to take the responsibility as a teacher of recitation of the Qur'an. The awareness towards the responsibility is vital as teaching the content of the Qur'an lies within the teachers themselves (al-Qabisi, 1955).

Apart from being highly knowledgeable in both aspects mentioned, the KKQ teachers are also highly knowledgeable in the area of substantive knowledge. This also shows that the KKQ teachers are proficient in theories and concepts of each Quranic Tajweed subject and construct them into a more clear and rich way for the understanding of the students. Knowledge of teachers towards the construct of syntactic knowledge showed that the KKQ teachers implement instructional recitation of the Qur'an in accordance to the requirements of the syllabus provided (Turner-Bisset, 2009). In addition, KKQ teachers are highly skilled in presenting appropriate examples of each topic that is being taught and highly knowledgeable in choosing the teaching aids used to be applied in teaching to enhance students' understanding of the lesson content that are being delivered (Turner-Bisset, 2009; Ahmad Yunus, 2011).

The research findings show that KKQ teachers have depth information in the aspect of content knowledge and syllabus and this gives the impression that they have acquired all of the topics covered in the modules of Quranic Tajweed. The in-depth knowledge that the teachers have acquired makes it easier for them to construct questions on the Quranic Tajweed. Apart from having the expertise in constructing questions, teachers of KKQ also have high knowledge on the relevance of each topic in the Quranic Tajweed subject. Knowledge is important as it help teachers in delivering new information on the lessons of recitation of the Qur'an based on the existing knowledge acquired by students.

In the meantime, the findings of the final constructs showed that teachers of KKQ have high proficiency in the aspects of related knowledge discipline with Quranic Tajweed lessons. They are not only proficient in the Quranic Tajweed lessons but are well versed in the other Quranic lessons such as Qur'an *tarannum*, *qiraat Sab'ie* and many others. Being proficient of these skills implies that the teachers of KKQ are also experts in Quranic Tajweed subject as this is the foundation of other skills in the Qur'an. A person could not consider to be well versed in the Qur'an *tarannum* if they are weak in Quranic Tajweed skills, and so it goes.

The research findings showed that there is no significant difference in the level of KKQ teachers' content knowledge in teaching Quranic Tajweed based on demographic aspects such as gender, *sanad* certificate and school location. Further results revealed that KKQ teachers have different level of content knowledge in teaching Quranic Tajweed based on the aspect of university background and teaching experience. Details of these findings, found that KKQ teachers from local universities have higher content knowledge of Quranic Tajweed than the ones graduated from foreign universities. In terms of teaching experience, teachers with experienced of more than 10 years were found to have higher level in content knowledge of Quranic Tajweed subjects than the teachers with teaching experienced in a period of 1-5 years.

As a whole, there is a significant correlation at low levels between pedagogical content knowledge with the achievement of the Quranic Tajweed in KKQ students. This finding indicates that this knowledge does not attribute a big impact to the achievement of students in the Quranic Tajweed teachings. This does not apply in the context of the Quranic Tajweed lessons alone, but also occurs in the studies on correlation between pedagogical content knowledge and students' achievement in academic aspect (Nik Mohd Rahimi, 2012). However, this knowledge could not be ignored or taken lightly as it is one of the most important considerations in managing and planning the process of teaching (Ferrell, 1995).

Detailed findings for each construct found that there are only four constructs showed a significant relationship with the achievement in Quranic Tajweed of KKQ's students which are the construct of readiness of teachers, substantive knowledge, syntactic knowledge and mastery of other relevant disciplines. Meanwhile, two other constructs; the perception towards KKQ and the proficiency in pedagogical content knowledge and syllabus had no significant relationship with students' achievement in the Quranic Tajweed.

## RESEARCH IMPLICATION

The overall findings of the study indicated that the KKQ teachers have the high level of pedagogical content knowledge in Quranic Tajweed lessons. The knowledge level should be maintained or enhanced by implementing the appropriate activities from time to time. For example, via organizing educational courses related to Quranic Tajweed lessons by authorities such as the school administration. For the KKQ teachers, they need to give full commitment by attending related courses regarding the subject. This is because the unilateral efforts alone is not effective for the improvement in pedagogical content knowledge of teachers in Quranic Tajweed lessons as this effort needs both parties involved which are the organizers and the teachers themselves.

Analysis of the differences found that the level of KKQ teachers' pedagogical content knowledge in Quranic Tajweed lessons for graduated teacher from the local universities was higher than the ones who graduated from universities abroad. Therefore, it is acceptable to increase the number for the recruitment of teachers that graduated from local universities. Furthermore, they usually acquire the study in the field of Quranic education specifically during their time in universities. The findings also shows that KKQ teachers with more than 10 years teaching experienced were found to have higher pedagogical content knowledge of Quranic Tajweed compared to the teachers who teach within 1-5 years. This implies that the teaching experience influences the level of KKQ teachers' pedagogical content knowledge in Quranic Tajweed lessons. Meaning that the KKQ teachers who has been teaching in a longer period have a higher level of knowledge in pedagogical content knowledge and so it goes.

The implementation of correlation analysis found that there was several constructs of pedagogical content knowledge that needs to be addressed in improving students' achievement in Quranic Tajweed lessons. These constructs are; the readiness of teachers, substantive knowledge, syntactic knowledge, and mastery of other relevant disciplines. Aspects of substantive knowledge and mastery of other relevant disciplines should be given a special emphasis because both constructs have the greatest influence on KKQ students' achievement in Quranic Tajweed lessons.

## CONCLUSION

In general, KKQ teachers have a high level of knowledge in pedagogical content knowledge of the Quranic Tajweed lessons. However, the level of knowledge is viewed differently in the demographic aspect of teachers based on the university background and teaching experience. The findings show that KKQ teachers which graduated from a local university and experienced teaching for more than 10 years have a higher level of pedagogical content knowledge than those who graduated abroad and experienced teaching within 1-5 years period.

Pedagogical Content knowledge is influenced towards the students' achievement in the Quranic Tajweed lessons. Correlation analysis for each construct of pedagogical content knowledge pedagogy showed two constructs that have the greatest influence on the achievement which are the construct of substantive knowledge and the mastery of other relevant discipline.

## REFERENCES

Al-Qur'an al-Karim

Abdul Fattah, As Syeikh Abdul Fattah (2011). *Nabi muhammad guru dan pendidik terulung*. Terj. Hj. Shuhadak Mahmud. Bahau: M Khari Enterprise.

Ahmad Sahli Mohd Hasan. (2008). *Kelas Kemahiran al-Quran (KKQ) di SMKA Falahiah Pasir Pekan: Tinjauan mengenai metodologi pengajaran dan keberkesanannya*. Tesis Sarjana, Universiti Malaya, Kuala Lumpur.

Ahmad Yunus Kasim. (2011). *Pengetahuan pedagogikal kandungan (PPK) pengajaran akidah: Kajian kes guru cemerlang pendidikan Islam*. Tesis PhD, Universiti Kebangsaan Malaysia, Bangi.



- Alkariah Mamat, & Sofiah Ismail. (2010, November). *Kaedah pengajaran dan pembelajaran guru pemulihan jawi di Malaysia*. Kertaskerja dibentangkan dalam seminar Proceedings of The 4 International Conference on Teacher Education; Join Conference UPI & UPSI, Bandung, Indonesia.
- Al-Qabisi. Abi Hasan Ali Muhammad Khalaf. (1955). *Ar-Risalah al-Mufasssolah li ahwal al- mua'allimin wa ahkam al- mua'allimin wal mutaalimin*. Kaherah: Dar Ehya' al-Kutub alArabiyyah.
- Al-Shaibani, Omar Muhammad al-Toumy. (1991). *Falsafah Pendidikan Islam*. Terj. Hassan Langgulong. Shah Alam: Hizbi.
- Ary, D, Jacobs, L. C; Razavieh, A. (2002). *Introduction to research in education*. Belmont USA: Wadsworth/Thompson Learning.
- Azmil Hashim. (2010). *Penilaian pelaksanaan kurikulum Tahfiz Al-Qur'andi Darul Qur'anJakim dan Maahad Tahfiz Al-Qur'anNegeri (MTQN)*. Tesis Phd. Universiti Kebangsaan Malaysia.
- Bennet, N. (1993). Knowledge bases for learning to teach. Dalam N. Bennet & C. Carre (Eds. ) *Learning to teach*. London: Routledge. Cohen, L, Manion, L & Morrison, K. (2000). *Research methods in education*. London: Routledge Falmer.
- Cohen, L, Manion, L, & Morrison, K. . (2000). *Research methods in education*. London: Routledge Falmer.
- Davis, K. , & Newstrom, J. W. . (1985). *Human behaviore at work: organizational behavior*. Singapore: Mc Graw Hill.
- Dorahim Bin Maidin, & Ab Halim Tamuri. (2011). *Tinjauan kaedah pengajaran dan pembelajaran tilawah al-Quran*. Kertaskerja dibentangkan dalam 2<sup>nd</sup> International Conference on Islamic Education 2011, Bangi - Putrajaya, Selangor, Malaysia.
- Edail Mat. (2010). *Kelas Khas Kemahiran al-Qur'an (KKQ): kajian kaedah pelaksanaan dan keberkesanannya di Sekolah-Sekolah Menengah (SMK) di Daerah Gombak, Selangor*. Tesis Sarjana. Akademi Pengajian Islam. Kuala Lumpur: Universiti Malaya.
- Fraser, Bruce. (1990). Perspectives on politeness. *Journal of Pragmatics*, 14, 219–236.
- Gall, J. P; Gall, M. D & Borg, W. R. (2005). *Applying educational research a practical guide*. Boston: Allyn and Bacon.
- Ghazali Darusalam. (2001). *Pedagogi Pendidikan Islam*. Kuala Lumpur: Utusan Publications & Distributors Sdn. Bhd.
- Grossman, P. L. (1987). A Passion For Language: A Case Study Of Collen, A Beginning English Teacher. Dalam S. Gudmundsdottir. (1990). Values In Pedagogical Content Knowledge. *Journal Of Teacher Education*, 41 (3), hlm. 44-52.
- Gudmundsdottir, S. (1995). The Narrative Nature Of Pedagogical Content Knowledge. Dalam H. Mc Ewan. , & K. Egan (Eds. ) *Narrative In Teaching, Learning And Research*. New York: Teachers College.
- Hamidah Hamzah. (1998). *Latihan oleh pegawai-pegawai pusat perkembangan kurikulum Kementerian Pendidikan Malaysia*. Tesis Sarjana, Universiti Malaya, Kuala Lumpur.
- Ibn Khaldun. (2000). *Muqadimah Ibn Khaldun*. Terj. Kuala Lumpur: Dewan Bahasa & Pustaka.
- Ibrahim Mamat. (1997). *Memimpin Remaja Sekolah Teori dan Praktik*. Kuala Lumpur: Kumpulan Budiman Sdn. Bhd.
- Jabatan Pendidikan Islam Dan Moral, KPM. (2005). *Kurikulum kelas Khas Kemahiran Membaca dan Menghafaz al-Quran*. Putrajaya. Bahagian Kurikulum Pendidikan dan Moral.
- Kementerian Pelajaran Malaysia. (2004). *Kurikulum Kelas Khas Kemahiran al-Quran, Tingkatan satu, dua dan tiga*. Kuala Lumpur: Bahagian Kurikulum Pendidikan Islam dan Moral, Jabatan Pendidikan Islam dan Moral, Kementerian Pendidikan Malaysia.
- Kerlinger, F. N. ( 1986). *Foundation of behavioral research (2nd edition)*. New York: Halt Rinehart and Winston.
- Magnusson, S. , Krajcik, J. S. , & Borko, H. (1994). *Teaching complex subject matter in science: Insight from an analysis of pedagogical content knowledge*. Kertas kerja yang telah dibentangkan di Annual Meeting of the National Assosiation for Research in Science Teaching, Mac 26-29, Antheim, CA.

- McDiarmid, G. W. , Ball, D. L. , & Anderson, C. A. (1989). Why saying one chapter ahead doesn't really work: subject-specific pedagogy. Dalam M. Reynolds (Ed. ), *Knowledge Base for the beginning teacher*. Oxford, UK: Pergamon.
- Mohd Abbas Abdul Latif & Farihatun Nadia Yaacob. (2010). Persepsi Pelajar Terhadap Program Membudayakan Al-Qur'an Dalam Meningkatkan Tahap Keupayaan Pembacaan Al-Qur'an Mengikut Hukum Tajwid. Satu Kajian Di SMK Dato Bentara Luar. pp. 1-11.
- Mohd. Aderi Che Noh. (2011). *Pelaksanaan Kelas Kemahiran Al-Qur'an Di Malaysia: Satu Analisis*. Journal of Islamic And Arabic Education 3 (1) 47-58. UKM: Bangi.
- Mohd Aderi Che Noh. (2009). Amalan pengajaran Tilawah al-Quran: Satu tinjauan terhadap persepsi guru di Sekolah Menengah Hariian Malaysia. *Journal of Islamic and Arabic Education*, 1 (1), 57-72. ISSN 1985-6236.
- Mohd. Majid Konting. (2005). *Kaedah penyelidikan pendidikan*. Kuala Lumpur: Dewan Bahasa dan Pustaka.
- Mohd. Safwan Salleh. (2007). *Penyelidikan Kelas Kemahiran al-Qur'an di Sekolah Menengah Kebangsaan: kajian di Jabatan Pendidikan Kelantan*. Tesis Sarjana. Akademi Pengajian Islam. Kuala Lumpur : Universiti Malaya.
- Mohd Yusuf Ahmad. (2004). *Sejarah dan kaedah pendidikan Al-Quran*. Kuala Lumpur: Universiti Malaya.
- Mohd Yusuf Ahmad. (2000). *Sejarah dan Kaedah Pendidikan al-Quran*. Kuala Lumpur: Penerbitan Universiti Malaya.
- Nik Mohd Rahimi Nik Yusoff, Nurulhuda Hasan, Mahat Afifi. (2012, Mei). *Pengetahuan pedagogi isi kandungan (PPIK) pengajaran Bahasa Arab*. Kertaskerja dibentangkan dalam Persidangan Kebangsaan Pengajaran dan Pembelajaran Bahasa Arab, Bangi, Selangor.
- Noor Azimah Surip & Ab. Halim Tamuri. (2010). *Kaedah hafazan tilawah al-Qur'andalam pendidikan Islam*. Fakulti Pendidikan, Universiti Kebangsaan Malaysia ICIED 2010 m/s 489-501.
- Rohizani Yaakub & Shahabudin Hashim & Mohd Zohir Ahmad. (2005). *Pedagogi: Strategi dan Teknik Mengajar Dengan Berkesan*. Bentong. PTS Publication & Distribution Sdn. Bhd.
- Rosie Turner-Bisset. (2004). *Pengajaran pakar*. Kuala Lumpur: Institut Terjemahan Malaysia.
- Shahabudin Hashim, Rohizani Yaakub & Mohd Zohir Ahmad. (2003). *Pedagogi: Strategi dan Teknik Mengajar Dengan Berkesan*. Bentong: PTS Publications & Distributors Sdn. Bhd.
- Shaharom Noordin & Faridah Sapiee. (2010). *Tahap pencapaian pengetahuan pedagogi dan kandungan dalam kalangan bakal Guru Fizik*. 1-7. (Unpublished)
- Shulman, L. S. , & Grossman, P. L. (1998). *The intern case teacher case book*. San Francisco, CA: Far Laboratory for Education Research and Development.
- Shulman, L. S. (1987). *Knowledge and teaching: Foundations of the new reform*. Harvard Educational Review 57: 1-22.
- Shulman, L. S. (1986). *Those who understand: Knowledge growth in teaching*. Educational Researcher 15 (2): 4-14.
- Wilson, S. M. , Shulman, L. S. , & Richert, A. E. (1987). "150 different ways" of knowing: Representations of knowledge in teaching. Dalam J. Calderhead (Ed. ), *Exploring Teachers' Thinking* (hlm. 104-124). London: Cassell.
- Yusuf Al-Qardhawi. (2003). *Sunnah: Sumber ilmu dan peradaban*. Penterjemah. Muhammad Firdaus. International Islamic Thought Malaysia. Selangor.

## A Qualitative Study on the Application of Problem-Based Teaching Theory on Music Education: the Example of Artvin Çoruh University

Prof. Dr. Ömür BÜTEV DOLĞUN

Dean of the Faculty of Arts and Design,

omurdolgun@gmail.com

### Abstract

*The understanding of education where student participates in the classes actively has taken place of the traditional teacher-based understanding in the student-centered education understanding which is one of the changes put forward by modern education view. What is important here is to assure that learning is more effective, efficient and permanent through the active participation of the student in the learning process. One of the modern learning methods developed for this purpose is Problem-based Learning. This theory can be summarized as giving the student a problem and having him/her on the problem; searching solution; forming the solutions in the most appropriate way by analyzing them; and finally presenting them to the teacher. In addition to the arts and music education generally given in the traditional way, the application of modern learning theories onto these fields may be of significance in terms of reaching new and extraordinary results. The application of Problem-based Learning method which is one of these learning theories is quite recent. In this study, a problem related to music education for children has been presented to the teacher candidates, who are sophomores in Class Teaching, in accordance with the Problem-based Learning theory and they have been expected to gather information on the subject, to reach a synthesis and to find a solution. Later, the results reached by the candidates who work as groups are examined by the qualitative research method.*

**Keywords:** Problem-based Learning, Music Education, Modern Education.

## 1. INTRODUCTION

### 1.1. Problem-Based Learning

It can be said that technological and scientific developments bring together the developments and innovations in education. The World sees increasingly developing innovations; it is even at such a degree that it becomes difficult to adapt to these innovations. The innovations in communication increase together with technology. Education, which can be considered a branch of communication, changes rapidly with these innovations. The traditional teacher-based education system is being replaced by a new system where students participate in the learning process actively. Here the student is not in a passive situation; in contrast, s/he is in an active position. Modern learning theories get renewed by changing at the same rate as parallel to this condition.

Problem-based Learning Theory is one of the mentioned modern learning theories; and, as every modern learning theory, it has a wide area of application in terms of its being applicable to every field. It can be mentioned that it involves creativity and the infiniteness of the imagination power like many modern learning theory. It may be said that memorizing information is left aside, that the individual questions every information s/he gets and establishes new ideas by incorporating information into experiences.

"PBL is used to cover an amazing diversity of educational practices, ranging from problem-oriented lectures to completely open experiential learning environments aimed at improving interpersonal relations." (Graaff and Kolmos, 2003: 657)

PBL Theory is separated from traditional learning theories in terms of several points: students make research on a specific subject on their own, they work in a group by cooperating with others, they reach a conclusion by synthesizing the information they gathered.

"...the 'Seven Step' method was developed to help student analyse the problem:

1. clarify the concepts;
2. define the problem;

3. analyse the problem;
4. find the explanation;
5. formulate the learning objective;
6. search for further information; and
7. report and test new information. ” (Graaff and Kolmos, 2003: 659)

## 1. 2 The importance of teaching songs in music education for children

It is known that music is useful and effective in both music courses and other courses by starting from the pre-primary period. The lyrics and expressions that take place in music exist in the children's minds, who are at early ages, longer and in a more effective way and the children can easily adapt information, which they get in this way, to their future lives more easily. Therefore, the use of songs suitable for children in other courses as well as in music courses will provide that the learnt information will be long-lasting and will not be forgotten.

## 2. METHOD

### 2.1. The Research Method

In this study, an example developed by a researcher in order to apply Problem-based Learning, which is one of the modern learning theories, to music education is presented. In the study, Content Analysis method, one of Qualitative Research Methods, is used. "Content analysis method aims at reaching some conclusions beyond the psychological, sociological, historical, economic, etc. information gathered from the message by evaluating some qualitative or quantitative signifiers". (Bilgin, 2014: 14)

### 2. 2 Data Gathering and The Instruments of Data Gathering

In the study, an example of a research made within the context of "Music Teaching" course of the sophomore of class teaching. As sample, total 36 teacher candidates, 22 of whom are female and 14 of whom are male, who are the students of Class Teaching Main Branch of the Primary Education Department at Artvin Çoruh University. First, the views of the teacher candidates on the music education regarding teaching songs are taken by open-ended questions and their answers for these questions are examined through content analysis method. Besides, according to PBL theory, the candidates are required to compose a song for children at 6-10 age groups by dividing into groups. The theme of the song is determined as the nature love.

### 2. 3 Data Gathering Period and Process

The teacher candidates are divided into nine groups composed of four people for this study and they are required to present the most suitable and the most beautiful song (s) that they composed as a group. The candidates are given two-week-period for this purpose. At the end of this period, the solution ways are presented by examining the songs composed by the candidates.

## 3. FINDINGS

Primarily, a music education is given to the candidates of Class Teaching for about three and a half months.

1<sup>st</sup> week: General information on music, sound and rhythm concepts and their characteristics

2<sup>nd</sup> week: Notation, basic elements of notation, explanation of note and es values

3<sup>rd</sup> week: Series and tonality concepts, examples and analysis

4<sup>th</sup> week: Modality concept, examples and analysis

5<sup>th</sup> week: Tune concept, examples and analysis

6<sup>th</sup> week: Intervals (Intervalle); consonance and dissonance concept, examples and analysis

7<sup>th</sup> week: General Review

8<sup>th</sup> week: Examination

9<sup>th</sup> week: Music speed terms, examples and analysis

10<sup>th</sup> week: Music nuance terms, examples and analysis

11<sup>th</sup> week: Figuration, explanation through examples, the characteristics of children's songs

12<sup>th</sup> week: The analysis of children's songs

13<sup>th</sup> week: General Review

After the given music education, the importance of songs in the music education for children is asked to the teacher candidates, and they are required to compose a song for children in the light of the gathered data in accordance with PBL theory.

### 3.1. The importance of songs in music education

After this education, the teacher candidates' views on whether songs are important in music education for children were asked. Only two students mentioned that they thought songs are not important in music education. According to one of these candidates, "The children's understanding music is more difficult compared to adults. Therefore, they may have difficulty in perceiving both lyrics and songs. Music may be long lasting but it may be difficult to keep the lyrics in mind" (C22). The other teacher candidates mentioned that "children are more interested in the music they hear rather than the song they learn at school" (C23). It is worth attention that these candidates are female. The views of the teacher candidates who claim that songs are important in music education can be examined under the following headings.

Table 1.

Views		f	%
It is important in child development	Female	5	62,5
	Male	3	37,5
	Total	8	100
It contributes to learning	Female	11	73,34
	Male	4	26,66
	Total	15	100
It is both entertaining and educative.	Female	0	0
	Male	5	100
	Total	5	100
It arises interest because it is for children.	Female	2	50
	Male	2	50
	Total	4	100

It increases the interest and love for music course.	Female	1	100
	Male	0	0
	Total	1	100
It contributes to behaviour development.	Female	1	100
	Male	0	0
	Total	1	100

The ratio of the teacher candidates who say “**It is important in child’s development**” to the total candidates is 23. 5%. The following examples can be given for these candidates’ views.

“S/he can express her/himself through songs” (C24)

“It contributes to the psychological and physical needs of children” ( C18)

“Because music is effective in the mental development of children” ( C29)

“It contributes to emotional development” (C1)

“Music affects the development of children” (C31)

The ratio of the teacher candidates who say “**It provides contribution in learning**” to the total candidates is 44. 1%. The following examples can be given for these candidates’ views.

“It provides that it stays longer in the minds of children and it motivates them” (C7 and C8)

“It makes it easier that children learn more effectively” (C14).

“We can teach the basic information that they must learn” (C35)

“Children take songs as model” (C12)

“I think it will be effective because vocalization of lyrics by a rhythm includes audial learning as well” (C11).

The ratio of the teacher candidates who say “**It is both entertaining and educative**” to the total candidates is 14. 7%. The following examples can be given for these candidates’ views.

“...I think it will be more entertaining to explain them a subject” (C27)

“The child shows interest in music because songs are entertaining” (C36)

“ Songs are sources of entertainment for children. ” (C34)

The ratio of the teacher candidates who say “**It arises interest because it is for children**” to the total candidates is 11. 8%. The following examples can be given for these candidates’ views.

“It reflects children’s World” (C9)

“ Music is the nutrition for spirit. ” (C25)

The ratio of the teacher candidates who say “**It increases interest and love for music education**” to the total candidates is 2. 95%. This candidate expressed him/herself as saying “It provides that the child loves music course more and takes pleasure” (C3).

The ratio of the teacher candidates who say "**It contributes to behaviour development**" to the total candidates is 2.95%. This candidate expressed him/herself as saying "It may form a new behaviour or change it" (C6).

### 3.2. Determining whether the given music education is sufficient for song composition

32 candidates mentioned that it is sufficient and 4 candidates mentioned that it is insufficient as response to this question. What takes attention in the explanations of candidates that express that it is insufficient is that they do not feel themselves sufficient in this matter. 3 of these candidates are female and 1 is male. The answers to the question why they feel in this way are as following:

"I cannot make word harmony" (C12)

"I think that I cannot adapt similar intervals and rhythms and that I cannot make the harmony between lyrics and music" (C15)

"I cannot make the harmony between lyrics and music. I cannot compose a good song" (C16)

"I cannot escape from excessive skipping" (C28)

### 3.3 Determining the views about which characteristic of a children's song is important

On this matter, 23 of the candidates give the answer that "song lyrics are suitable" (13 female, 10 male), six give the answer that "voice width is suitable" (5 female, 1 male), six give the answer that "it is suitable for subjects or units to be explained" (3 female, 3 male), a female candidate gives the answer that "it is composed of same or similar intervals". That is, while the ratio of female candidates who mention "song lyrics are suitable" is 56.5%, the ratio of male candidates is 43.5%. It is seen that there is almost an equality in this point". Regarding the point "Voice width's being suitable", the ratio of female candidates is 83% while that of male candidates is 17%. In the other view, there is an equality. Despite this, the view "it is composed of same or similar intervals" is seen significant only by a female student. The points "it is composed of same or similar rhythms" and "escaping from excessive skipping" are not marked by any candidate.

### 3.4 Determining their views about whether they are sufficient while composing a children's song.

23 candidates answered that they thought they were not sufficient and 13 mentioned that they were sufficient. Of the candidates who mentioned they were not sufficient and therefore would experience difficulty, 14 were female and 9 were male. Of the candidates who mentioned they were sufficient and therefore would experience no difficulty, 9 were female and 4 were male.

As seen here, the ratio of female candidates who thought they were not sufficient and would have difficulty in the composition step is 60% while the ratio of male candidates is 40%; the ratio of female candidates who thought they were sufficient and would have no difficulty in the composition step is 69% while the ratio of male candidates is 31%.

### 3.5 Determining the reason behind teacher candidates' experiencing difficulty, who thought they would have difficulty in composing a children's song

As a result of the answers given on the questionnaire, it is observed that the ratio of the teacher candidates who think they will experience difficulty if they are required to compose a children's song is 23 candidates from 36 candidates in total. 14 of these candidates are female and 9 of them are male. It is seen that the class gave negative answer to this questions and the reasons are asked to the candidates.

As a result of this, the points that the teacher candidates who think composing a suitable song for children will force them are those: "the song's lyrics being suitable for children" and "sound width's being suitable for children". It is seen that both conditions take the first rank as a result of the answers of 8 candidates. It takes attention that "the song's lyrics being suitable for children" is at a high rate as 8 in female candidates while male candidates do not mention this point. On the other hand, "sound width's being suitable for children" is equal in male and female candidates. In the following answers,

“escaping from excessive skipping” and “its being suitable for subject or units to be explained” are marked as 4 candidates as the subject that they will have difficulty most at the stage of composing a children’s song. Another interesting point is that the candidates who marked both choices are males. The point that the song to be composed is “made of same or similar rhythms” is mentioned by two candidates (one male, one female). Finally, a female teacher candidate marked the point that “it is composed of same or similar intervals”.

### 3. 6. The evaluation made after the stage of composing a children’s song

The field where they experience most difficulty at the stage of composing a children’s song is asked to 36 teacher candidates. The following conclusions are made as a result of their answers:

- 1) 10 (5 female, 5 male) of teacher candidates mentioned that the field where they had most difficulty resulted from the fact that song lyrics should be suitable for children. The ratio of these candidates to the total is 27. 78%.
- 2) 9 (6 female, 3 male) of teacher candidates mentioned that the field where they had most difficulty resulted from the fact that the sound width should be suitable for children. The ratio of these candidates to the total is 25%.
- 3) 10 (4 female, 6 male) of teacher candidates mentioned that the field where they had most difficulty resulted from the fact that it should be composed of same or similar rhythms. The ratio of these candidates to the total is 27. 78%.
- 4) 2 (2 female) of teacher candidates mentioned that the field where they had most difficulty resulted from the fact that it should be composed of same or similar intervals. The ratio of these candidates to the total is 5. 55%.
- 5) 3 (3 female) of teacher candidates mentioned that the field where they had most difficulty resulted from the fact that it is necessary not to make excessive skipping. The ratio of these candidates to the total is 8. 34%.
- 6) 2 (2 female) of teacher candidates mentioned that the field where they had most difficulty resulted from the fact that it should be suitable for the subject or unites to be explained. The ratio of these candidates to the total is 5. 55%.

## 4. CONCLUSION AND DISCUSSION

Within the framework of these answers given to questions in the questionnaire, the task of composing a song which has lyrics that children can easily understand, which is composed of same or similar rhythms and intervals, the sound width of which is suitable for children, which escapes from excessive skipping and which is suitable for subject or units to be explained.

With the questionnaire applied after the given music education, it is aimed that the awareness of the teacher candidates and their focus on the subject increase.

The results reached by the teacher candidates through working in groups composed of four people can be summarized as following:

- 1) The children’s songs composed by teacher candidates are melodic and can easily be sung by the children at the age group of 6-10. (According to the results in the questionnaire, the teacher candidates mentioned that they had most difficulty on this point)
- 2) The lyrics of children’s songs composed by teacher candidates can easily be understood by the children at the age group of 6-10. (In this respect, the point which takes place among the top concerns that lyrics are not suitable for the mentioned age group is inappropriate. According to the results in the questionnaire, the teacher candidates mentioned that they had most difficulty on this point)
- 3) The concern about skipping from the same or similar intervals is mentioned by 1 candidate at the beginning of the study; and it did not come true, relatively. Songs are quite successful in this respect.



- 4) The point about escaping from same or similar rhythms is mentioned by only two candidates at the beginning of the study; however, it is marked by 10 candidates in the evaluation questionnaire made at the end of the study. The conclusion made here is that the views can change when one starts practice.
- 5) The problem of escaping from excessive skipping between the notes—which is one of the subject which is feared most—is mentioned only by two teacher candidates, three candidates mark as the point where they had most difficulty.
- 6) The problem of composing a song suitable for subject or units to be explained is marked only by two candidates according to the results obtained from the questionnaire made at the beginning of the study; again, two candidates mark it as the point where they had most difficulty.

## 5. SUGGESTIONS

Among the modern learning theories, one theory on which researchers study most is “Problem based Learning”. In this theory, a problem, which is quite possible that they may face in their lives, is presented to students; they are required to make research; students reach a synthesis through information they gathered; and a common solution way is determined. Apart from the information given during the lesson, it is possible to benefit from this theory in music education which is expected to be based on creativity and the power of imagination. Indeed, some situations experienced in life are not actually problems. It can be said that it is the humankind itself who turn some situations into problem. This point can be realized in the field of education and the problem can be handled creatively. If music education is given as example, it can be said that the subject, which is told in a more suitable way for children, can be understood more easily. In this study, a situation chosen in accordance with the Problem Based Learning Theory is presented to the teacher candidates and authentic works which candidates can easily use are obtained. It can be said that such kind of creative studies should spread over more fields and that encouraging teacher candidates in such area will contribute to the enrichment of the future education life.

## 6. REFERENCES

- Bacanlı,H. ,Çeliköz,N. ,Erişen,Y. ,Şahin,M. ,Eyyam,R. ,Doğruer,N. ,Meneviş,İ. ,Özerbaş,M. A. ,Özü,Ö. ,Çakmak,M. ,Kılıç,D. ,Gündoğdu,K. ,Kayabaşı,Y. ,Silman,F. ,Baysen,E. , Erişti,B. ,Akdeniz,C. ,Tok,H. ,Sünbül,A. M. ,Kurnaz,A. ,Karataş,E. ,Karataş,S. , Yalın,H. İ. Editör: Kaya,Z. (2012). Öğrenme ve Öğretme Kuramlar, Yaklaşımlar, Modeller. Ankara: Pegem Akademi.
- Bilgin,N. (2014),Sosyal Bilimlerde İçerik Analizi,Teknikler ve Örnek Çalışmalar (Genişletilmiş 3. Baskı),Ankara: Siyasal Kitabevi.
- Fer,S. ,Cırık,İ. , Altun,. S. ,Çolak,E. ,Özkılıç,R. ,Şahin,E. ,Avcı,S. , Yüksel,S. , Turan, H. Editör: Fer,S. (2011). Öğrenme Öğretme Kuram ve Yaklaşımları. Ankara: Anı Yayıncılık.
- Graaff,E. ,Kolmos,A. ( 2003). Characteristics of Problem-Based Learning. Int. J. Engng Ed. ,19 (5),657-662. <http://citeseerx.ist.psu.edu/viewdoc/download?doi=10.1.1.455.3467&rep=rep1&type=pdf>
- (Erişim tarihi: 28. 02. 2015)
- Kılınç,A. (2007). Probleme Dayalı Öğrenme. Kastamonu Eğitim Dergisi,15 (2),561-578.  
[http://www.kefdergi.com/pdf/15\\_2/akilinc.pdf](http://www.kefdergi.com/pdf/15_2/akilinc.pdf)
- (Erişim Tarihi: 28. 02. 2015)
- Koçakoğlu,M. (2010). Probleme Dayalı Öğrenme: Yapılandırıcılığın özü. Milli Eğitim Sayı: 188,68-82.  
[http://www.vizyon21yy.com/documan/Egitim\\_Ogretim/Egitim/Ogretim\\_Yont\\_Teknikl/Probleme\\_Dayali\\_Ogrenme.pdf](http://www.vizyon21yy.com/documan/Egitim_Ogretim/Egitim/Ogretim_Yont_Teknikl/Probleme_Dayali_Ogrenme.pdf)
- (Erişim Tarihi: 28. 02. 2015)
- Yıldırım,A. ,Şimşek,H. (2013). Sosyal Bilimlerde Nitel Araştırma Yöntemleri. (Genişletilmiş 9. Baskı) Ankara: Seçkin Yayıncılık.

---

## Is It Easier for Minority Groups to Integrate in the Work Force When They are Self-Employed? a Case Study in the Israeli Labor Market

Tal Shahor

The Academic College of Emek Yezreel, Israel.

tals@yvc. ac. il

### **Abstract**

*One of the main problems facing many countries today is the integration of minorities in the labor market. This problem applies in countries with a high immigrant intake and also in countries where the minorities are indigenous. Israel has a Jewish majority which manages the economy and an Arab minority which should be integrated in the labor market. One question that arises in this case study is whether the minority sector is better able to become integrated in the labor market as wage earners or as self-employed. The goal of this study is to examine this question in the context of the Israeli economy by comparing between the Arab sector and the Jewish sector. The first stage of the study compared the income of the self-employed compared to the income of wage-earners in each population group. The results at this stage showed that in the majority group, the income level of the wage-earners and the self-employed is almost the same, whereas in the minority group the income level of the self-employed is much higher than the wage-earners (a gap of 33% in favor of the self-employed). The second stage of the study examined the effect of the level of education on the decision to be self-employed in each of the population groups. To this end, we checked the self-employment rate for each level of education. The results showed that in the minority group (Arab sector) the level of education of the self-employed is higher than that of the wage-earners, whereas in the majority group (Jewish sector) the level of education of the self-employed is lower.*

**Keywords:** self-employed; labor market; minorities; Israel.

### **Introduction**

In recent years, many countries have found it necessary to address the question of how to integrate minority groups into the labor market. This question is relevant in countries that have a constant intake of immigrants and also in countries with an Indigenous minority. To successfully integrate minority groups into the labor market, we must first check if the pattern of employment of the minority group differs from that of the majority. This study compares between the self-employed and the wage-earners in each of the population groups. The research question for the purpose of this article is whether there are differences between the minority group and the majority group in three specific areas: the rate of self-employed in the work force, the income level of the self-employed compared to the income level of the wage-earners, and the level of education of the self-employed compared to the level of education of the wage-earners.

Numerous studies have examined the subject of wage-earning workers and the self employed throughout the world. David & Blanchflower (2004) carried out a study that was based on surveys performed in a number of OECD countries. In that study, the first section examined each of the countries separately, and the second section examined all the countries together in a group context. The results of this study showed that gender was one of the factors that affected the self-employment rate. More men are self-employed, although between the years 1994 to 2002, the gap between the number of self-employed men and self-employed women decreased. Age is another factor that affects the rate of self-employment. The rate of self-employed increased relative to the increasing age of participants in the study but only up to a certain level (up to age 54 in 1994 and up to age 61 in 2002), after which the number of self-employed began to decrease. The effect of education on the self-employment rate is less clear. In most countries in Europe increased education is linked to a decrease in the self-employment rate. However in the USA, the opposite occurs – the self-employment rate increases together with the increased level of education. The same result was received when the data was examined using a continuous variable of age, and also when the data was examined using dummy variables for various age groups. The outcome is also not uniform for the question of self-employment rates in ethnic minorities. In some countries in Europe, the self-employment rate among ethnic minorities is higher than in the general population. However, in the USA there is less self-employment among Afro-Americans and Hispanics, apparently because of a lack of initial financial liquidity. In other

---

countries a lack of financial liquidity may also be the factor that prevents people from becoming self-employed. Many wage-earning employees report that they would prefer to be self-employed. The question to be asked was why they did not become self-employed. There are those who maintain that people do not report what is actually good for them. But the findings indicate that the self-employed are more satisfied with their work. Therefore the question that still remains unanswered is why so few wage-earning employees become self-employed.

### **International Comparison**

According to Blanchflower (2004), a comparison of self-employment rates between countries or between periods, necessitates differentiating between self-employed farmers and the self-employed in other areas because during recent decades, the number of self-employed farmers has decreased in the majority of countries. Furthermore, usually, in those countries that are more developed, the methods of cultivation have improved thereby requiring a smaller number of farmers. This process does not stem from social or economic reasons which we seek to examine but rather from technological developments in agricultural cultivation. And if we check the self-employment rate including farmers, we will find that in the majority of countries there has been a decrease in self-employment over the years. If we consider those who are self-employed but are not farmers, in some countries we can actually see an increase in the numbers.

An interesting question to ask is "Does having a large number of self-employed (in this case the majority of whom will be small business owners) benefit the economy?" Many countries support "small" independent businesses based on the thinking that this is the way to promote economic development particularly in the weaker layers of society. According to this approach, small businesses can create jobs with a smaller investment. However, the study by Davis, Haltiwanger and Schuh (1996, p. 57) claims that while small businesses do indeed generate many new job opportunities they also cause the loss of many old jobs because the average lifetime of small businesses is shorter. It is therefore unclear whether the existence of numerous small businesses at the expense of large businesses does actually increase the rate of employment. However it is clear that the larger businesses do actually create more stable jobs. An article by Wagner (2004) which examined the subject of entrepreneurship<sup>1</sup> found that the better the financial state of the families the more likely they were to become entrepreneurs. Examination of the effect of education on entrepreneurship revealed that low and high levels of education reduced entrepreneurship; in other words, the highest level of entrepreneurship can be found in the population with an average level of education. The study led by Wagner also compared the rate of entrepreneurship in different countries. The study examined, among other aspects, the correlation between the rate of entrepreneurship and the GNP, and found that a U-shaped<sup>2</sup> correlation linked the two parameters. The implication of this correlation is that in poor countries the rate of entrepreneurship is high apparently because work opportunities for wage earners are limited. Consequently, an increase in the GNP (and an increase in employment opportunities) reduces the number of entrepreneurs. However, at a certain GNP level the rate of entrepreneurs once again increases, seemingly because in these countries the funds required to establish a business are more readily available.

Ginding and Newhouse (2014) studied the subject of wage-earners and the self-employed in developing countries. In these countries the main problem is how to extract the poor farmers from the cycle of poverty. According to this study, this goal can be achieved in two stages. In the first stage, the farmers need to be helped to become independent in non-agricultural areas, and only in the second stage do they need to be helped to become wage-earners. The significance of this finding is that being self-employed can be a stage in the progression of economically weak groups on the way to becoming integrated into the workplace. Andersson and Wadensjö (2003) found that in Sweden and Denmark, the rate of self-employment among immigrants is much higher than in the rest of the population. Additionally, they found that the income of self-employed immigrants is lower than that of wage-earning immigrants. They reached the conclusion that immigrants who chose to be self-employed did so because they were experiencing difficulties finding employment as wage earners in jobs with a reasonable pay rate. The study by Zulema (2013) which examines the rate of self-employment among immigrants in the USA paints a different picture. According to this study, the rate of self-employment among new immigrants is lower than the rate of self-employment in the general population, but this rate grows over time. Zulema maintains that

---

<sup>1</sup> The study by Wagner looks at entrepreneurs, in other words, people who set up new businesses. It does not deal with the number of self-employed who are already operating.

<sup>2</sup> Similar results were found in an article by van Stel et al. (2003)

over time the changes in the rate of self-employment among immigrants may indicate the level of their integration in American society at least in terms of their economic status. The study refers to three integration options:

1. Independence as a process of integration in the mainstream: the immigrant undergoes a final stage of joining the mainstream of the society in a process that is consistent and final. In the area of independence, this process is one in which the rate of self-employed converges with the accepted rate in the general population. In this process there should not be any difference between men and women.
2. Independence as a process of downward integration: the number of self-employed remains lower than in the rest of the population. The lack of integration is more extreme among the men and consequently the rate of self-employment will be even lower.
3. Independence as a hindrance to integration: the immigrants have traits that are suitable for becoming entrepreneurs and self-employed (immigrants that come to the USA from Korea are a case in point). Consequently the rate of independence among them is greater and perhaps even grows over time. This process delays integration because they are less integrated in the work place, and focus on their own occupational areas.

Other studies drew different conclusions. George (1986) found that in the 1970s and 1980s the rate of self-employment among immigrants in the USA was higher. Shahor (2014) found that in Israel the rate of self-employment in the minority sectors was higher. However, it is possible that also in Israel the convergence of the rate of self-employed minorities with the rate of self-employed in the main social sector (in other words, the Jewish sector) could indicate economic integration. There is another interesting finding in the study done by Zulema (2013) which indicates that the influence of age on the self-employment rate has an inverse U shape; in other words, the rate of self-employment is lower among the young and the elderly, and is higher among the middle-aged generation.

This study focuses on Israeli citizens living inside the Green Line (Israel's border until 1967 as determined by the United Nations). The majority of citizens within these borders are Jewish (80%), and there is a large minority of Arabs (the remaining 20%). Within the population of Arabs who are Israeli citizens (and are therefore included in this study), the vast majority are Muslims; approximately 10% of the Arab population are Christians, which in many ways (birth rate, level of education, etc.) differentiates them from the Muslim group. In socio-economic terms, the state of the Arab minority is inferior. One of the components contributing to the low socio-economic status that is addressed in this study is the inferior state of Arab sector employment, and in particular the wages earned for work performed. Epstein, Gharrah and Cohen (2001), Hasson Abu Assabah (2004), Hasson and Kariyeini (2006) found employment inequality which has its origins in the lack of employment options in the Arab settlements, and the difficulties encountered by Arabs when they attempt to become part of the workforce in Jewish settlements. Additionally it was found that despite the improved education of the Arab workforce, they are unable to realize their full potential in the Israeli work force. Friedman and Zussman (2008) found that between the years 1987 to 2005, the difference in the hourly rate of pay paid to Jews and Arabs had actually increased. There are a number of approaches that could explain the differences in the rates of pay received by the different employee groups:

1. Human Capital approach – this approach, presented by Becker (1993), claims that an employer operating in a competitive market who aims to increase the profits as much as possible, will pay the employee according to their marginal output. This approach maintains that if an employee with human capital produces more than an employee without human capital, the employee with the human capital should be earning a higher wage.
2. Sex Segregation approach (Haberfield 1990) – this approach focuses on the characteristics and attributes of the labor market (whereas the Human Capital approach focuses on the employee and their attributes). In this approach, the wage is paid according to profession and not according to employee. Some professions are more important to the employer than other professions and positions. According to this approach, Jews will earn more than Arabs if the jobs that they are performing are among those for which the employer pays a higher rate.
3. Another possibility is that of discrimination against one of the sectors in the population (in this case, against Arabs): According to the human capital approach, discrimination occurs when the average wage of the Arabs is lower than that of the Jewish population even though the average human capital of the Arabs is similar to that of the Jews. According to the sex segregation approach, there is evidence of discrimination when lower wages are paid for professions performed by Arabs.

In all three cases, the end result is that Arabs find it difficult to become integrated into the Israeli workplace as wage-earning employees. One way to circumvent this difficulty is to join the self-employed sector, where the person does not have to "show their papers", and their income is determined by their ability to meet the needs of their customers. It can therefore be assumed that the rate of self-employment in the Arab sector will be greater, and that the disparity in wages earned between Jews and Arabs in the self-employed sector will be smaller than the disparity in the wage-earning sector.

### **Empirical Study**

The data for this study were taken from the income survey for 2011 (the most recent survey available at the time of writing of this article). The first stage involved examining the average traits of the various population groups, divided according to status in the workplace (wage-earners or self-employed), ethnic group (Arabs or Jews), and gender (male and female). Table 30 below lists the rate of self-employment among all the workers in each of the different groups.

Table 30: Self-Employment Rate among All Workers in Each Population Group

	Arabs	Jews	Arab to Jewish Ratio
Men	0.145	0.156	0.931
Women	0.061	0.079	0.779
Total	0.121	0.117	1.04

As can be seen in Table 30, among the men there is very little difference between the Arabs and the Jews. Among the women, the difference the Arabs and Jews is greater. However, it is important to note that the data in this table show the self-employment rate for all workers. The number of working women is small<sup>1</sup> therefore the data for this group is likely to be problematic. Table 31 below shows the income of the self-employed in relation to the income of wage-earners according to the same groups.

Table 31: Self-Employment Rate among All Workers in Each Population Group

	Arabs	Jews	Arab to Jewish Ratio
Self-employed Income (Men)	7,884	11,540	0.683
Wage-earner Income (Men)	5,948	11,146	0.534
Self-employed to Wage-earner Ratio	1.33	1.04	
Self-employed Income (Women)	4,748	7,318	0.649
Wage-earner Income (Women)	4,734	6,858	0.683
Self-employed to Wage-earner Ratio	1.01	1.07	

<sup>1</sup> The sample for this survey includes 37 self-employed Arab women compared to 220 self-employed Arab men, 1302 self-employed Jewish men, and 679 self-employed Jewish women.

The interesting point in Table 31 is the fact that the income earned by self-employed Arab men is much higher (33%) than the income earned by wage-earning Arab men. This result could indicate that it is difficult for male Arab workers to become integrated as wage-earners in the Israeli labor market, and therefore are more successful as self-employed.

Table 32 below shows the number of years of education for each group.

Table 32: Years of Education

	Arabs	Jews
Years of Education Self-employed (Men)	11. 76	13. 93
Years of Education Wage-earner (Men)	11. 64	14. 18
Ratio of Self-employed to Wage-earners	1. 01	0. 98
Years of Education Self-employed (Women)	11. 46	15. 07
Years of Education Wage-earner (Women)	13. 29	14. 17
Self-employed to Wage-earner Ratio	0. 86	1. 06

The interesting conclusion to draw from Table 32 is the fact that among the men, there is no significant difference in the level of education between the wage-earners and the self-employed. This is noticeable in light of the fact that the income earned by the self-employed Arab is significantly higher than the income of the Arab wage-earners. The fact that there is no difference in the level of education raises the possibility that the Arab men are not managing to utilize their level of education in the general labor market, and consequently are succeeding more as self-employed. The only group showing a significant difference between years of education of the self-employed and years of education of the wage-earners is the group of Arab women where the level of education of the self-employed women is the lowest of all the groups. In the men's group, we can see that the level of education of the Jewish men is the highest (which could be the reason for the difference in income); however, the disparity between self-employed and wage-earning men in both groups (Arab and Jewish) is negligible. As mentioned previously, the number of self-employed Arab women in the sample is very small, thereby making it difficult to reach conclusions regarding this group. For this reason, from this point forward, the study will focus only on the men.

Another way to check the level of education is by reviewing the diplomas that the workers received from the last educational institute in which they studied. (See Table 33 below)

Table 33: Data (in %) for Diplomas Received from Last Educational Institute

Level of Education	Type of Diploma	Arabs			Jews		
		Self-Employed	Wage-Earner	Self-employed to Wage-earner Ratio	Self-Employed	Wage-Earner	Self-employed to Wage-earner Ratio
Low	Elementary	31%	35%	0. 91	13%	9%	1. 54
	High School	21%	24%	0. 91	26%	20%	1. 31
	Matriculation	16%	20%	0. 83	13%	20%	0. 65

Middle	Non-Academic Tertiary	13%	6%	2. 13	16%	17%	0. 94
High	BA	11%	11%	1. 00	19%	19%	1. 01
	MA + PhD	3%	3%	0. 98	11%	14%	0. 80

As can be seen above, in the Arab sector the rate of self-employed males with low education is lower than the rate of wage-earners with the same level of education. In the Jewish sector the situation is reversed – in the Jewish sector, the rate of self-employed males with a low level of education is higher than the rate of wage-earners with the same level of education. If we look at those with a middle level of education (non-academic tertiary education), we will see that the situation is switched around. In the Arab sector, the rate of self-employed males with non-academic tertiary education is much higher than the rate of wage-earners in the Arab sector. At the high levels of education the rate of self-employed and the rate of wage-earners in the Arab sector is similar. The data in this table demonstrates that the trend among Arabs with education to become self-employed is stronger than the trend among Jews with the same education.

Table 34: Rate of Self-Employed in Jewish and Arab Sectors by Field of Occupation

	Self-employed Arabs	Self-employed Jews
Agriculture	0. 04	0. 07
Industry	0. 09	0. 07
Electricity & Water	0. 00	0. 00
Construction	0. 25	0. 12
Car Mechanics	0. 30	0. 18
Food	0. 02	0. 03
Transport	0. 09	0. 09
Banking	0. 02	0. 03
Real Estate	0. 11	0. 25
Management	0. 00	0. 00
Education	0. 01	0. 03
Health	0. 02	0. 05
Services	0. 05	0. 08

As can be seen in the table above, the two areas in which there is a significant difference between the Jewish and Arab sectors is car mechanics and construction. The Arabs specialize in both these areas (55%) which both require non-academic tertiary education.

### **Factors that Influence Wages (checked using Regression)**

In this section, we will examine two questions. The first question is what are the factors that affect the difference between self-employed income and wage-earner income. The second question is what are the factors that affect the difference

between the income of self-employed Jews and the income of self-employed Arabs<sup>1</sup>. In this case too, the sample refers only to men. Observations of people who are not working, or of people who are working both as wage-earners and as self-employed were not included in the sample. Additionally, observations were not included for workers who had an unclear level of education. In the end, the sample consisted of 9220 observations.

The dependent variable in the model is income earned by the workers (self-employed and wage-earning workers).

The independent variables are:

1. Dummy variable for self-employed worker
2. Dummy variable for self-employed **Arab** worker

When these two variables are used together in the regression, the coefficient of dummy variable for self-employed worker shows the difference between wage-earning worker and **Jewish** self-employed worker; and the coefficient of self-employed **Arab** worker shows the difference between self-employed Jewish and self-employed Arab.

3. Years of education: according to the accepted hypothesis workers with more years of education will receive a higher income.

4. Dummy variable for marriage: based on previous studies, it can be assumed that the income of married men will be higher.

5. Year of birth: based on previous studies, income and age are linked in a U-shape. This variable will therefore appear twice – once linearly, and the second time to the power of 2.<sup>2</sup> Although there is concern about a link between the marriage variable and the year of birth, the correlation coefficient between them is only -0.48.

6. Type of diploma received from last educational institute: this item refers to the diploma received by the worker from the last educational institute in which he studied. The possibilities are: graduation from elementary school, graduation from high school, certificate of matriculation, graduation from a non-academic tertiary educational institute, Bachelor of Arts (BA), Master of Arts (MA), Doctor of Philosophy (PhD). The type of diploma is expressed in the regression by using a sequence of dummy variables. Each institution is allocated a dummy variable. Workers for whom this institution is their last place of study will therefore receive the value "1" while all the other workers will receive a value of "0". It is known that when using a sequence of dummy variables one group must be left without a variable. In the regression of this study, the group without the variable was the workers whose last diploma received was from graduating elementary school (the lowest level of education possible).

Note that all these variables check the condition of the workers, while the purpose of this study is to check the differences between the self-employed and the wage-earners and between Arabs and Jews. Therefore, in addition to the six variables mentioned above, two more groups of variables were added to the regression:

- A. Each of the variables from 3 to 6 were multiplied by a dummy variable for a self-employed worker.
- B. Each of the variables from 3 to 6 were multiplied by a dummy variable for a self-employed Arab worker.

In order to understand the effect of the doubled variable, we will take the example of the education in years variable. In the regression, if the three following variables that appear (1) years of education; (2) years of education multiplied by the dummy variable for self-employed; (3) years of education multiplied by the dummy variable for Arab self-employed; then the coefficient of years of education will show the effect of years of education on wage-earners, the second variable will show the difference between the effect of years of education on the wage-earners and their effect on Jewish self-employed, and the coefficient of the third variable will show the difference between years of education of a self-employed Jew, and the years of education of a self-employed Arab.

Analyzing these variables in a different way shows that the total of the first two coefficients (the coefficient for the number of years of education, and for the number of years of education of the Jewish self-employed) demonstrates the effect of the number of years of education on the income of self-employed Jews. Using the same method of analysis but with three

<sup>1</sup> The difference between the wages earned by Jewish wage-earners and wages earned by Arab wage-earners is subject matter for another study.

<sup>2</sup>  $(Year\ of\ birth)^2$ ;



coefficients (adding to the previous total the third coefficient for the years of education for Arab self-employed) shows the effect of years of education on the income of self-employed Arabs.

The same effect will be produced by multiplying each of the other variables by dummy variables. Table 35 shows the outcome of the regression. Variables with a level of significance of over 5% were omitted from the regression, and are therefore not included in the table. It can be said the variables that do not appear in the table do not affect the income.

Table 35: Factors Affecting Income (Regression Results)

Variable	Coefficient
Years of education	634
Number of years of education of self-employed	-299
Number of years of education of <b>Arab</b> self-employed	-197
Self-employed (Dummy variable)	4,257
Year of birth	22,012
Year of birth to the power of 2- (Year of birth) <sup>2</sup>	-5.6
Married (Dummy variable)	1,814
Matriculation	833
BA (Dummy variable)	4,225
MA (Dummy variable)	6,178
PhD (Dummy variable)	8,173
Intercept	-21,553,745
Adjusted R-squared	0.23

The most interesting conclusion in terms of this study involves the effect of the number of years of education on the income of self-employed Jews in comparison to the effect on the income of self-employed Arabs. As can be seen, the coefficient for the variable "Number of years of education of self-employed" and also the coefficient for the variable "Number of years of education for self-employed Arab" are negative. These results are significant because they show that the effect of the number of years of study on the income of self-employed Arabs is smaller than the effect it has on the income of self-employed Jews<sup>1</sup>.

This result can indicate that educated Arabs find it difficult to integrate into the Israeli labor market as wage earners and therefore many Arabs with higher education are self-employed. The outcome is that many Arabs with higher education are self-employed in occupations that are not particularly high-paid. Consequently, in the Arab sector the number of years of study does not greatly influence the level of income. As shown in table 32, the ratio between the average income of the

<sup>1</sup> Another way of viewing these results is to calculate the coefficient totals. The total of the coefficients for the first two variables ("years of study" and "years of study of self-employed") is  $634 - 299 = 335$ , and the total of all three variables ("years of study", "years of study of self-employed", and "years of study of self-employed Arabs") is  $634 - 299 - 197 = 138$ . In both cases, the total of the coefficients is positive, but the total that includes the coefficient for the variable "years of study of self-employed Arabs" is smaller.

self-employed and of wage-earners in the Arab sector is 0.683 compared to 0.534 in the Jewish sector. It is probable that the fact that Arabs with higher education are self-employed rather than working as wage-earners is one of the factors that contribute to this situation.

If we review the other coefficients, we will find that the coefficient for the dummy variable "Married" is positive. In other words the income of married men is greater. No difference was found in this field between self-employed and wage-earners or between Arabs and Jews (dummy variables for marriage according to groups that were not significant). This is similar to the results of studies that were carried out in other parts of the world. If the effect of age is checked, it is possible to see that the coefficient Year of Birth is positive and that the coefficient of Year of Birth to the power of 2 is negative. This is significant because the link between the year of birth and income is an inverted U shape (the maximum income is received at age 51). Also on this point we did not find any difference between wage-earners and self-employed or between Jews and Arabs. This result matches the results of studies carried out in other parts of the world. In the list of dummy variables for different types of diplomas, it is possible to see that as we go higher up the list of diploma type the coefficient also increases; in other words, the income increases. Also here we did not find a significant difference between wage-earners and self-employed, or between Jews and Arabs.

## **Conclusion**

One of the important problems that the world must deal with today is the integration of ethnic minorities in the general labor market which is usually dominated by the ethnic group which comprises the majority in the country. One of the subjects addressed in this context is the way in which the workforce of each of these two groups is divided between wage-earners and the self-employed. In this framework the study examined whether there are differences between the minority group and the majority group in three areas: the rate of self-employment in the work force, the level of income of the self-employed compared to the wage-earners, and the level of education of the self-employed compared to that of the wage-earners. The study examined these questions against the Israeli economy where the minority group includes the Arab community while the majority group consists of the Jewish community. Although the minority group in this study does not consist of immigrants, in many ways their situation is similar to that of immigrant groups in European countries.

The results of the study indicate that the rate of self-employment in the majority and the minority groups is almost identical. However, in contrast with this finding, significant differences were found in the area of income and the effect of education. In the majority (Jewish) group the income earned by the self-employed and by wage-earners was almost the same, whereas in the Arab (minority) sector the income of the self-employed was higher. It is important to note that the income of the Jewish group is much higher in both the self-employment sector and in the wage-earners sector. It therefore seems that the relative advantage of the Arabs in the self-employed sector is derived primarily from weakness in the wage-earners sector. In another result that reinforces the conclusion regarding education it is interesting to see that the effect of education on the income of self-employed Arabs is less than the effect of education on the income of wage-earning Jews. This result could indicate that educated Arabs experience difficulties integrating into the Israeli labor force as wage-earners and consequently many Arabs with higher education are self-employed. According to the conclusion that can be derived from these results, the Arab sector has a relative advantage in the self-employment sector that stems from weakness in the wage-earning sector. The government must therefore, at least in the short term, encourage the self-employment sector of the minority group thereby enabling them to increase their income and to improve their socio-economic situation. Studies carried out in other countries found that the main problem in this area is the lack of financial liquidity and their inability to receive credit. It is important to find ways that will enable the minority group to overcome these obstacles. In the long term, ways need to be found that will also enable minority groups to become effectively integrated into the labor market as wage-earners.

## **REFERENCES**

Andersson, P. , & Wadensjö, E. (2004). Self-employed immigrants in Denmark and Sweden – a way to economic self-reliance?. IZA, Discussion Paper No. 1130. Retrieved from [http://papers.ssrn.com/sol3/papers.cfm?abstract\\_id=542822](http://papers.ssrn.com/sol3/papers.cfm?abstract_id=542822)

1. Becker, G. S. (1993). *Human Capital: A Theoretical and Empirical Analysis, with Special Reference to Education*. Chicago: University of Chicago Press
2. Blanchflower, D. G. (2004). Self-Employment: More May Not Be Better. *Swedish Economic Policy Review*, 11 (2), 15-74.
3. Davis, S. J. , Haltiwanger, J. C. , & Schuh, S. (1996). *Job creation and destruction*. Cambridge, MA: MIT Press,
- Friedman, F. ,& Zussman, N. (2008). Labor Quality in Israel. In *Research Department, Bank of Israel*. Retrieved from <http://www.boi.org.il/he/Pages/Default.aspx>.
- George, J. B. (1986). The Self-Employment Experience of Immigrants. *NATIONAL NBER*, Working Paper No. 1942. retrieved from <http://www.nber.org/papers/w1942.pdf>.
4. Gharrah, R. , & Cohen, R. (2001). Poverty Among Israeli Arabs and Sources of Inequality Between Arabs and Jews. *The Economic Quarterly*, 48, 485 – 517.
5. Gindling, T. H. & Newhouse D. (2014). Self-Employment in the Developing World. *World Development*, 56, 313–331.
6. Haberfield, Y. (1990). *Salary discrimination against women in Israel: a conceptual framework, research methods, findings and trends*. *Human Resources and Labor Relations in Israel*. Tel Aviv: Ramot.
7. Hasson, S. , & Abu-Asbah, K. (2004). Jews and Arabs in Israel Facing a Changing Reality. In *Floersheimer Studies*. Retrieved from [http://www.fips.org.il/Site/p\\_publications/item\\_en.asp?doc=&iss=&iid=661](http://www.fips.org.il/Site/p_publications/item_en.asp?doc=&iss=&iid=661).
- Hasson, S. , & Karayanni, M. (2006). Barriers to Equality: The Arabs in Israel. In *Floersheimer Studies*. Retrieved from [http://www.fips.org.il/Site/p\\_publications/item\\_en.asp?doc=&iss=&iid=768](http://www.fips.org.il/Site/p_publications/item_en.asp?doc=&iss=&iid=768).
- van Stel, A. , Sander, W. , Thurik, R. , Reynolds, P. , & de Wit, G. (2003). Explaining nascent entrepreneurship across countries. *SCALES-paper N200301, EIM Business and Policy Research*. Retrieved from [www.eim.nl](http://www.eim.nl).
- Wagner, J. (2004). Nascent Entrepreneurs. *IZA*, Discussion Paper No. 1293. Retrieved from <http://ftp.iza.org/dp1293.pdf>.
- Zulema, V. (2013). Self-Employment as an Indicator of Segmented Assimilation among Six Ethnic Minority Groups. *Entrepreneurship Research Journal*, Manuscript 1063. Retrieved from <http://www.degruyter.com/view/j/erj.2012.2.issue-4/2157-5665.1063/2157-5665.1063.xml>.

## Comparing 2011 General Election and 2014 Presidency Election in Turkey with Regard to Political Marketing

Hakan Yaş

[www.trakya.edu.tr](http://www.trakya.edu.tr) Trakya University Havsa Vocational School,  
Hakan Okursoy Campus 22500 Havsa / Edirne / TURKEY, [hakanyas@trakya.edu.tr](mailto:hakanyas@trakya.edu.tr)

Yasin Usta

[www.trakya.edu.tr](http://www.trakya.edu.tr) Trakya University Havsa Vocational School,  
Hakan Okursoy Campus 22500 Havsa / Edirne / TURKEY, [yasinusta@trakya.edu.tr](mailto:yasinusta@trakya.edu.tr)

Sedef Zeyrekli Yaş

[www.trakya.edu.tr](http://www.trakya.edu.tr) Trakya University Havsa Vocational School,  
Hakan Okursoy Campus 22500 Havsa / Edirne / TURKEY, [sedefyas@trakya.edu.tr](mailto:sedefyas@trakya.edu.tr)

### Abstract

*Leaders and political parties which are one of the products of political marketing are the political products. Social issues and the requirements that are the result of these issues determine the route map of leaders and the party programme. It is hard for a party and for a leader that do not embrace neither their grassroots nor the needers of the grassroots of other parties, to protect their position. Social media being used as a instrument of political marketing plays a crucial role in especially affecting young electorate at the present time. This instrument have been begun to be used by politicians actively in Turkey recently. Till the enact of the Law No. 5678 which made an amendment in 1982 Constitution in 2007, the President of Turkey had been elected by the votes of the parliamentarians in Turkish Grand National Assembly. As a result of the amendment in 1982 Constitution in 2007, Turkish citizens have become enable in electing the President of Turkey via referendum. From a different point of view, this amendment also, hereinafter, enables candidates to make their own propaganda in order to increase their votes. In this paper, 2014 Presidency Election in Turkey in which there were three candidates Recep Tayyip ERDOĞAN, Ekmeleddin Mehmet İHSANOĞLU and Selahattin DEMİRTAŞ, is considered in terms of using social media. The aim of the paper is to present the differences of the propaganda instruments of the candidates that they used in election process, and how these instruments affected the results of the elections. It is also sought that how the usage of social media and number of followers affect the results of the elections.*

**Keywords:** Leader, Propaganda, Elections, Political Marketing, Social Media

### 1. Introduction

Although the political sciences and marketing sciences are apart areas from each other, both areas benefit from certain techniques such as target group or market, the techniques related to target group or market, picking and fragmentation of target group or market, and of which the elements of marketing mix could be used. Since for years in west of the world but yet the recent years in developing countries, it is beholden that marketing instruments have begun to be run in political campaigns as an instrument of propaganda being conducted by political candidates.

The concept of 'marketing' can be defined in several ways. Some of the scholars define the concept as "an exchange operation towards to meeting basic needs and desires of people" ... "to give some valuable things (commodity, facility or idea) to the opposite side in order to meet their each own needs between two or more sides, and to gain other valuable things (money, receivable, loan etc. )" (Mucuk, 1999: 3), whereas some defines it as "...the whole activities managing the

*products and services from producer to customer in order to satisfy customers and -at the same time- to reach the goals of company..."* (Mc Carty, 1975: 19).

Prior to presenting the definition of political marketing, making the definition of 'politics' is crucial. Politics can be defined as *"the science of behaviours taking a role in the formation of institutions related to political authority and in their operating"* and it is asserted that the politics is constituted to respond a certain requirement of all structures and of all institutions in a society (Kışlalı, 1987: 4-14). In this perspective, politics is –itself– such an instrument by which the social needs are expected to be met. Supporting this assessment, political marketing is defined as *"all kinds of activities regarding promoting and introducing people -who are candidate to meet voters needs and desires-, or parties and their programmes to voters"* (Özkan, 2004: 21). In political marketing, thus, leaders of political parties, parliamentarians, mayors and such people, and political parties, political propagandas and similar activities can be deemed as political products. Companies, however, use the marketing activity to create a competition advantage. As for in companies, political parties, leaders and programmes are also in a competition. In order to affect floating votes, political parties and leaders conduct their campaigns intensively via marketing activities (Okumuş, 2007: 156).

Some scholars simulate arguments of politics and arguments of marketing as the following (Divanoğlu, 2008: 106):

Arguments of politics	Argument of marketing
Leader, party programme and candidates	Product
Going to polls, voting, membership fees, grants, subsidies	Price
Mass communication devices, volunteer or paid labor, provincial and subprovincial organizations, social activities and meetings held	Distribution
Advertisement, public relations, personal propaganda, publicity, newsworthy programmes, and vote-rising other activities	Promoting

The differences between commercial and political marketing are customer-wise manner – citizen-wise manner (the description of need, the description of target group, differentiated goods and services, strategies of superiorities), customer or social satisfaction – voters' satisfaction, integrated market – integrated marketing (Üste et al. , 2007: 216).

The political parties whose organizational culture is based on volunteerism achieve, recently, their runnings by the help of liaising with political consultancy companies without leaving volunteerism. These companies have integrated the elements of marketing mix into the political process and thus the concept of political marketing has become evident. While determining the place of the person in the political life, political consultancy companies researches initially to what extent the society contributes to the manner and behaviours of the person and with which processes, and to what extent a person has a freedom of action and election.

Political marketing has three customer group and these are *"the ones would be member of parties, partisans and sympathizers of parties, the ones who have no other option though being not a partisan"* (Limanlılar, 1991: 35). Political marketing, here, should call out these three different groups. The two aims of the political marketing are to peg the ideas of party members, potential members and voting people, and to change the ideas of voters not voting the party. Some of the aims of the party and its leader, however, should be to intensify the positive manner of the members of, the partisans of and the voters of party, to change the manner of floating votes on behalf of party, and to change manner of people from negative to –at least– floating. At this point, the main event is not the injustice in or among the level of income but the disparities between the level of income and their expectations (Kışlalı, 1987: 67). Political leaders are successful to the extent that they could respond these expectations. The leader should be able to use his characteristics of self-reliance, steady character, honesty, vigor, creative intelligence, common sense and understanding (Yıldırım, 2011: 882).

The method taking party or leader to success is propaganda which is an instrument of political marketing. The definition of propaganda made by several scholars. Qualter's definition on propaganda is *"the deliberate attempt by the few to influence the attitudes and behavior of the many by the manipulation of symbolic communication"* (Qualter, 1985: 124). Domenach

explains it as “an undertaking of attracting the view and behavior of society so as to provide to internalize a certain view or behavior of people” (Domenach, 2003: 17). “The intentional control, manipulation and communication of information and imagery in order to achieve certain political objectives” is another definition of propaganda (Rutherford, 2000: 279)

Not completely denying the usage of internet or similar techniques, among some scholars there seems to be a consensus that it cannot replace face-to-face communication or etc (Johansen, 2012: 92). Some scholars, also, assert that with the arrival of new media such as internet, web TV or e-mail, the distribution function of political marketing will increase in complexity (Henneberg, 2002: 119). Similarly, Jackson infers from his research, in which he studies the members of parliament in United Kingdom in 2002, that email so far has not stimulated a relationship marketing approach (Jackson, 2005: 105). In addition to these studies, some directly work on new social media instruments. In their study, Bode & Dalrymple suggested that Twitter contains a unique audience for political elites to target. These users extremely interested in politics, very likely to turn out at the polls, and wealthy enough to contribute to campaigns. The important finding of this study is that as politicians, pundits, and politically interested citizens continue to turn to Twitter as a source of information and a form of political expression (Bode & Dalrymple, 2014: 22). Miller studied both Twitter and Facebook and called them new media in modern political campaigns. In his research he concludes that what makes new media attractive is cheapness, opportunity to enhance the images of candidates. But the shortcoming of this new media is its failure to reach a vast majority of voters (Miller, 2013: 342). Towner and Dulio, other scholars using the term new media for Twitter and Facebook –and also Youtube–, find new media likely “a futile proposition” and suggest that the rapid changes in new media require scholars to update the design and direction of future research (Towner and Dulio, 2012: 112).

In the light of all considerations above, in this paper it is, in brief, endeavoured to make an assessment of 2014 Presidency Election in Turkey, within the scope of Twitter and Facebook which are some of the instruments of new social media. The aim of the paper is to suggest the difference of the propoaganda instruments used by three candidates competing in 2014 Presidency Election, Recep Tayyip ERDOĞAN, Ekmeleddin Mehmet İHSANOĞLU and Selahattin DEMİRTAŞ, and how these instruments affected the votes. Besides, it is also studied how the usage of social media and the number of followers affect the votes. The instruments of propaganda and usage of social media in number are left out of the scope for 2011 General Election as social media was not used effectively by the leaders in the Election. Therefore, a comparison between the two elections is done and a determination of the power of effect of the social media is tried to be done by through assuming the effects of other factors as equal.

Thus, the main assumption of the paper is set as “political marketing has a positive affect on votes”. In this regard either political marketing techniques (social media and meetings) used by the candidates in the running process or the 2014 Presidency Election itself are also considered. In this context, the paper seeks to answer the following key questions:

- What are the differencies between the candidates in terms of methods and instruments used by them?
- How did these methods and instruments affect the votes?
- Did the candidates increase their vote rate in 2014 Presidency Electon if compared with 2011 General Election?

## 2. Analysis

### 2.1. Comparing the Candidates in Terms of Their Usage of Social Media

Social media and social communication are new propoganda instruments drawing its strength from people, carrying the people from passive to active following, consisting of people from all strata, to which politicians appeal for help in their campaigns, and about what they -on occasion- complain. The users who don't read or watch although preferring journals, magazines and television can share their thoughts in social media. The conventional methods of propoganda which can not respond to instant developments countrywide, such as visiting electoral area, are going useless, but one sentence shared in social media can be followed from all these areas. As stated in the previous chapter, in this paper Facebook and Twitter are regarded as social media or new media instruments, and analyzed.

Turkey is the 6<sup>th</sup> in the World ranking while it is 1<sup>st</sup> in Europe ranking in terms of the number of users of Facebook, with 31. 247. 120 users according to 2012 data which indicates that over the 40% of population of Turkey use Facebook. If this data is compared with the number of users of internet, it indicates that each nine of ten individuals has a Facebook account. At the 18 – 24 age range, there are over 10 million users with a share of approximately 34% of total, whereas at the 25 – 34

range 28% and 35 – 44 range 12% (Sabah, 2014). The number of users of Twitter, however, reached a number over 11 million by the year 2014, which means that each 4 of 10 individuals using internet use Twitter.

These data indicate that the number of using internet, Facebook and Twitter is growing rapidly in Turkey. Following and taking into consideration this reality, it is obvious that the candidates of 2014 Turkish Presidency Election have to prefer to use the social media actively.

Selahattin DEMİRTAŞ had rather use his Twitter account actively than his Facebook account. The number of his followers in Facebook is 1. 197. 739. The most of his followers are situated in İstanbul and he is followed mostly by the age range 18 – 24. He had 106 sharing in total, 17 of which are short-film, 82 of which are messages and photos taken in campaign running, and 7 of which are advertisements. Although he has two Twitter accounts, he had rather use @DegisiminAdayi account and run his campaign. In this account which has over 15. 000 followers, he released 1. 530 sharing, 172 of which are short film and the rest is 1. 222 messages. In addition to these accounts, he has also another web page [www.selahattindemirtas.net](http://www.selahattindemirtas.net) over which he presented his next events. According to data released on his web page, he raised totally 1. 213. 000 TL donation from 7. 119 donors. <sup>1</sup> He spent 1. 095. 000 TL of the total amount for promotion materials, transportation and audio system. (<http://www.selahattindemirtas.net/>, 2014). His site was created not only in Turkish but also in English and Kurdish.

Ekmeleddin Mehmet İHSANOĞLU used his Facebook account actively which was created in 2014, 24<sup>th</sup> of June and the number of his followers is 361. 097. The most of his followers are situated in İstanbul and he is followed mostly by the age range 18 – 24. He had 134 sharing in total, 50 of which are short-film, 69 of which are messages and photos taken in campaign running, and 15 of which are advertisements. In his Twitter account “@profdrhsanoglu”, he has 344. 551 followers and he released 357 sharing in total, 15 of which are short film, 311 of which are messages and 21 of which are advertisements. If his Facebook account is compared to his Twitter account, it is inferred that he used his Twitter account actively rather than Facebook in order to share message, and that the number of followers in his Twitter account is more than the number in Facebook. In addition to these accounts, he has also another web page [ihsanoglu.com](http://www.ihsanoglu.com) over which he presented his next events and made a call for raise donation. He raised totally 8. 500. 000 TL donation from an undeclared number of donors (<http://www.sozcu.com.tr/2014/gundem/iste-erdogana-yapilan-secim-bagisi-573957/>). His web page was created only in Turkish Language.

Recep Tayyip ERDOĞAN has 6. 390. 605 followers in Facebook. He has the most followers in İstanbul, and most followed by the age range 18 – 24. He had 98 sharing in total, 53 of which are message, 23 of which are campaign photos and 12 of which are advertisement. In his Twitter account “@RT\_Erdogan”, he has 4. 625. 669 followers. In his account from which he released 180 sharing, he had 6 short films, 17 advertisements and 157 messages. It is seen that he used his Twitter account more active rather than Facebook. Recep Tayyip ERDOĞAN who presented his running events from his personal web page [www.rte.com.tr](http://www.rte.com.tr), raised 55. 260. 778 TL donation from 1. 350. 796 donors (<http://www.trtturk.com/haber/cumhurbaskani-adaylari-ne-kadar-bagis-topladi.html>, 27. 08. 2014; <http://www.rte.com.tr/>, 16. 08. 2014).

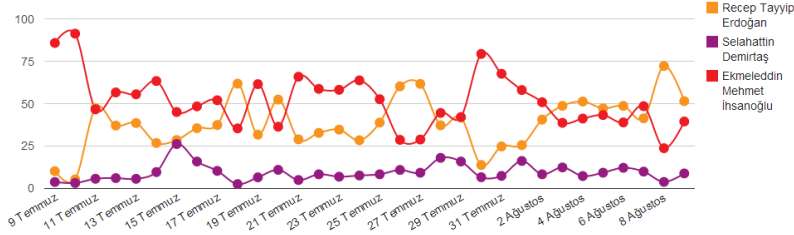
Candidates reached their voters also from Instagram and Youtube, but this lies outside the scope of the paper.

An increase occurred in Recep Tayyip ERDOĞAN’s “@RT\_Erdogan” Twitter account by the start of the election campaign and the number of followers increased by 98. 606 followers. However, his Facebook account increased in number with 97. 506 followers. Selahattin DEMİRTAŞ’s “@DegisiminAdayi” Twitter account followed by 15. 664 new followers, whereas his Facebook account followed by 21. 406 new followers. The effect of start of election was more in Ekmeleddin Mehmet İHSANOĞLU’s social media accounts than in other candidates. Thanks to the election, he created new accounts in Twitter and Facebook. His Facebook account and Twitter account were followed by 361. 097 and 344. 551 new followers respectively. The ratio of followers commented on candidates are as follows: on Recep Tayyip ERDOĞAN 49,60%, on Ekmeleddin Mehmet İHSANOĞLU 39,82% and on Selahattin DEMİRTAŞ 10,28%.

Table 1 indicates the change in number of followers of candidates in Twitter from 9<sup>th</sup> July to 8<sup>th</sup> August.

Table 1: The Number of Twitter Followers of Candidates Between The Days of 9<sup>th</sup> July- 8<sup>th</sup> August 2014

<sup>1</sup> According to Law No. 6271, candidates can raise donation from individuals or companies except individuals that are non-citizen of Turkey and foreign companies.

SOSYAL SEÇİM ADAYLARI ZAMAN TÜNELİ 

Resource: <http://www.haberturk.com/secim/secim2014/cumhurbaşkanligi-secimi>, 13. 08. 2014

Table 2: The Provinces in Which the Candidates Are the First

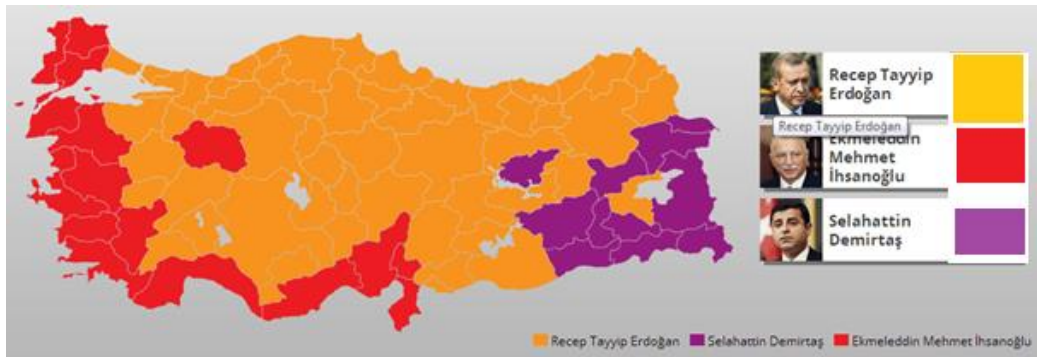


Table 3: The Candidates' Vote Numbers, The Comparison of Provinces and Metropolitans

CANDIDATE	THE NUMBER OF METROPOLITAN VOTED	THE NUMBER OF PROVINCE VOTED	VOTE RATE	THE VOTE NUMBER OF PRESIDENT ELECTIONS
RECEP TAYYİP ERDOĞAN	15	39	51,79	21. 000. 143
EKMELEDDİN İHSANOĞLU	12	4	38,44	15. 587. 720
SELAHATTİN DEMİRTAŞ	3	8	9,76	3. 958. 048



## 2.2. Comparing the Candidates in Terms of Their Meetings Held

Selahattin DEMİRTAŞ started his campaign running from İstanbul in 15<sup>th</sup> July and met his voters by visiting Kocaeli and Bursa in 16<sup>th</sup> July, in 18<sup>th</sup> July Basel and Paris, in 22<sup>nd</sup> July İstanbul, in 23<sup>rd</sup> July Muş, in 24<sup>th</sup> July Bitlis, Siirt and Tekirdağ, in 25<sup>th</sup> July Antalya, in 26<sup>th</sup> July Aydın, in 27<sup>th</sup> July Manisa, in 28<sup>th</sup> July Şırnak, in 29<sup>th</sup> July Hakkari, in 30<sup>th</sup> July İstanbul, in 31<sup>st</sup> July Hatay, in 1<sup>st</sup> August Mersin, Şanlıurfa and Gaziantep, in 2<sup>nd</sup> August Bingöl, Tunceli and İstanbul, in 4<sup>th</sup> August Ağrı, in 5<sup>th</sup> August Van, in 6<sup>th</sup> August Diyarbakır and Adana, in 9<sup>th</sup> August İzmir.

He gained his votes most in Şırnak, Hakkari and Diyarbakır with the ratios 83,13%, 81,27% and 64,10% respectively, whereas least in Bayburt, Yozgat and Çankırı with the ratios 0,75%, 1,00% and 1,00% respectively. His ranking in Şırnak, Hakkari, Diyarbakır, Ağrı, Muş, Van, Siirt and Tunceli, the provinces where he visited during his running, is 1<sup>st</sup>, whereas in Bitlis, Bingöl and Şırnak is 2<sup>nd</sup> and in other provinces is 3<sup>rd</sup>.

Table 4: Selahattin Demirtaş's Vote Density in Turkey

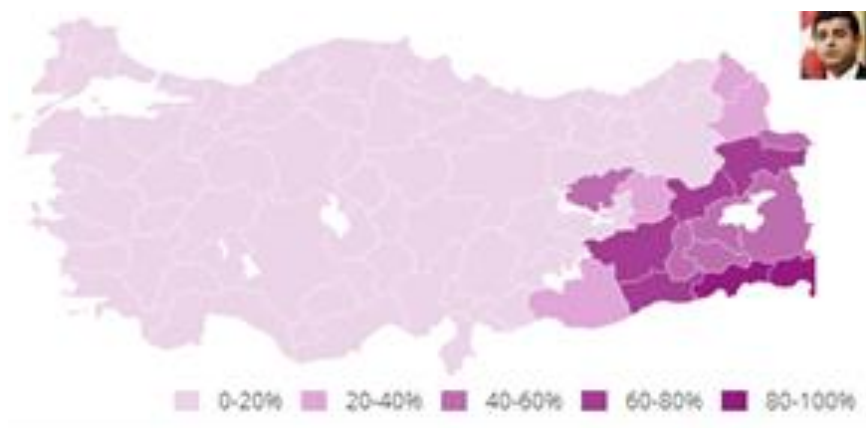


Table 5: Selahattin Demirtaş's Election Success in Provinces Run Campaign, The Comparison Analysis of President Election (2014) and General Election (2011)

SELAHATTİN DEMİRTAŞ <sup>1</sup>							
THE CAMPAIGN SUCCESS RANKING AMONG PROVINCES	PROVINCE	VOTE RATE %	HIS RANKING OF SUCCESS	PRESIDENT ELECTION VOTE COUNT	2011 GENERAL ELECTION VOTE COUNT	THE INCREASE NUMBER OF VOTE	INCREASE RATE %
1	ŞIRNAK	82,94	1	158569	125225	33344	26,63
2	HAKKÂRİ	81,65	1	102342	94580	7762	8,21

<sup>1</sup> The yellow-based rows indicates the provinces that the candidate visited during his running.

3	DİYARBAKIR	64,23	1	409681	340598	69083	20,28
4	AĞRI	61,54	1	121512	87915	33597	38,22
5	MUŞ	61,24	1	105248	75599	29649	39,22
6	MARDİN	60,89	1	198345	195041	3304	1,69
7	BATMAN	59,95	1	134266	113165	21101	18,65
8	VAN	54,49	1	222670	210332	12338	5,87
9	SİİRT	54,03	1	65373	51483	13890	26,98
10	TUNCELİ	52,24	1	41613	10344	31269	302,29
11	BİTLİS	43,67	2	60448	58475	1973	3,37
12	İĞDIR	42,90	1	30227	25388	4839	19,06
13	KARS	32,86	2	41187	27561	13626	49,44
14	BİNGÖL	30,54	2	37385	30110	7275	24,16
15	ŞANLIURFA	26,20	2	173691	182435	-8744	-4,79
16	ARDAHAN	23,07	3	11663	7081	4582	64,71
17	ADİYAMAN	15,25	3	43626	19960	23666	118,57
18	MERSİN	13,42	3	122134	93495	28639	30,63
21	ADANA	10,62	3	114035	92792	21243	22,89
22	GAZİANTEP	10,51	3	82659	44475	38184	85,85
23	İSTANBUL	9,06	3	648608	1261938	-613330	-48,60
24	İZMİR	7,95	3	187405	240478	-53073	-22,07
25	AYDIN	6,94	3	41568	23997	17571	73,22
27	MANİSA	5,57	3	45828	24193	21635	89,43
28	KOCAELİ	5,47	3	48713	21827	26886	123,18
29	ANTALYA	5,27	3	58046	28110	29936	106,50
32	TEKİRDAĞ	4,38	3	22245	7646	14599	190,94
38	HATAY	3,58	3	28151	11778	16373	139,01
44	BALIKESİR	2,82	3	21111	6757	14354	212,43
				3378349	3512778	-134429	-3,83

Recep Tayyip ERDOĞAN started his running from Samsun in 5<sup>th</sup> July and visited Erzurum in 6<sup>th</sup> July, Ankara and Denizli in 8<sup>th</sup> July, Tokat in 9<sup>th</sup> July, Yozgat in 10<sup>th</sup> July, Antalya in 12<sup>th</sup> July, Şanlıurfa in 13<sup>th</sup> July, Sakarya in 16<sup>th</sup> July, Tekirağ in 17<sup>th</sup> July, Bursa in 18<sup>th</sup> July, Ordu in 19<sup>th</sup> July, Hatay in 20<sup>th</sup> July, Adana in 23<sup>rd</sup> July, Mersin in 24<sup>th</sup> July, Eskişehir, Bilecik And İstanbul in 25<sup>th</sup> July, Diyarbakır in 26<sup>th</sup> July, Van and Mardin in 31<sup>st</sup> July, Kahramanmaraş and Manisa in 1<sup>st</sup> August,

Balıkesir and İzmir in 2<sup>nd</sup> August, Ağrı, Kocaeli and İstanbul in 3<sup>rd</sup> August, Aydın and Muğla in 6<sup>th</sup> August, Malatya and Gaziantep in 7<sup>th</sup> August, Kayseri and Ankara in August 8<sup>th</sup>, and Konya in 9<sup>th</sup> August.

He gained his votes most in Bayburt, Rize and Gümüşhane with the ratios 80,24%, 78,90% and 75,09% respectively, whereas least in Tunceli, Şirnak and Hakkari with the ratios 14,67%, 14,83% and 16,63% respectively. He did not prefer to make any running visit to the provinces where he was voted most, in contrast to his opponents who made the reverse. His ranking in Konya, Kahramanmaraş, Malatya, Sakarya, Erzurum, Şanlıurfa, Ordu, Kayseri, Samsun, Yozgat, Tokat, Gaziantep, Kocaeli, Bursa, Ankara, Bilecik, İstanbul, the provinces where he visited during his running, is 1<sup>st</sup>, whereas he is 2<sup>nd</sup> in Balıkesir, Denizli, Manisa, Eskişehir, Hatay, Van, Antalya, Adana, Tekirdağ, Mardin, Aydın, Ağrı, Diyarbakır, İzmir, Muğla, Mersin.

Table 6: Recep Tayyip Erdoğan's Vote Density in Turkey

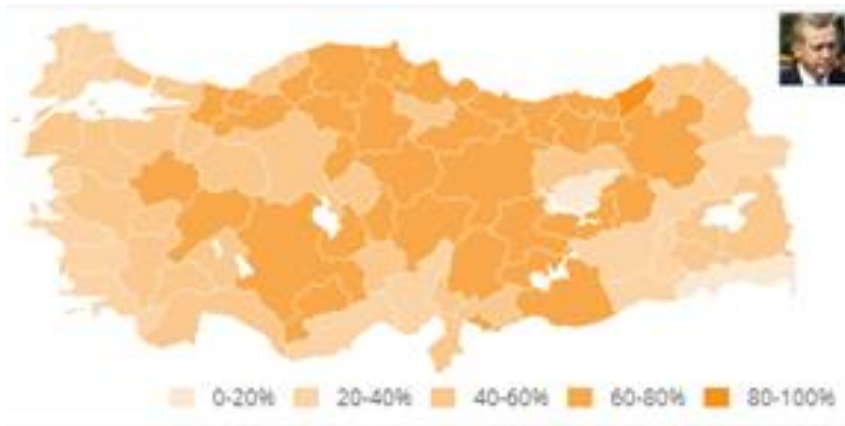


Table 7: Recep Tayyip Erdoğan's Election Success in Provinces Run Campaign, The Comparison Analysis of President Election (2014) and General Election (2011)

RECEP TAYYİP ERDOĞAN <sup>1</sup>							
THE CAMPAIGN SUCCESS RANKING AMONG PROVINCES	PROVINCE	VOTE RATE %	HIS RANKING OF SUCCESS	PRESIDENT ELECTION VOTE COUNT	2011 GENERAL ELECTION VOTE COUNT	THE INCREASE NUMBER OF VOTE	INCREASE RATE %
1	BAYBURT	80,24	1	34102	27201	6901	25,37
2	RİZE	78,90	1	148587	133987	14600	10,90
3	GÜMÜŞHANE	75,09	1	52499	44993	7506	16,68
4	KONYA	74,63	1	826792	807073	19719	2,44
5	AKSARAY	74,00	1	136863	131853	5010	3,80
6	ÇANKIRI	73,71	1	76265	72437	3828	5,28
8	K. MARAŞ	71,49	1	382945	390259	-7314	-1,87

<sup>1</sup> The yellow-based rows indicates the provinces that the candidate visited during his running.

10	MALATYA	70,29	1	285266	293377	-8111	-2,76
15	SAKARYA	69,08	1	349035	333384	15651	4,69
16	ERZURUM	68,83	1	250942	282436	-31494	-11,15
17	ŞANLIURFA	68,63	1	454976	428691	26285	6,13
18	ORDU	66,98	1	245784	250309	-4525	-1,81
21	KAYSERİ	66,14	1	474374	476428	-2054	-0,43
23	SAMSUN	65,88	1	447022	460035	-13013	-2,83
25	YOZGAT	65,85	1	155662	170222	-14560	-8,55
33	TOKAT	62,29	1	206764	201612	5152	2,56
35	GAZİANTEP	60,47	1	475202	508653	-33451	-6,58
38	KOCAELİ	58,54	1	521248	502110	19138	3,81
42	BURSA	54,88	1	848418	871796	-23378	-2,68
48	ANKARA	51,31	1	1405405	1465940	-60535	-4,13
49	BİLECİK	50,91	1	62052	54685	7367	13,47
52	İSTANBUL	49,84	1	3566474	3913708	-347234	-8,87
54	BALIKESİR	47,80	2	356945	355059	1886	0,53
55	DENİZLİ	47,09	2	268044	277951	-9907	-3,56
56	MANİSA	46,14	2	379180	405540	-26360	-6,50
57	ESKİŞEHİR	45,41	2	214498	221355	-6857	-3,10
58	HATAY	44,11	2	345934	352060	-6126	-1,74
59	VAN	42,65	2	174309	171012	3297	1,93
63	ANTALYA	41,63	2	458271	460693	-2422	-0,53
65	ADANA	38,92	2	417602	436364	-18762	-4,30
66	TEKİRDAĞ	38,21	2	193739	182748	10991	6,01
68	MARDİN	36,62	2	119293	102956	16337	15,87
69	AYDIN	36,75	2	219858	223349	-3491	-1,56
70	AĞRI	36,46	2	72336	96197	-23861	-24,80
72	DİYARBAKIR	33,50	2	214023	217602	-3579	-1,64
73	İZMİR	33,38	2	786547	920362	-133815	-14,54
74	MUĞLA	32,26	2	164666	169449	-4783	-2,82
76	MERSİN	31,99	2	291092	309603	-18511	-5,98
				16083014	16723489	-640475	-3,83

Ekmeleddin Mehmet İHSANOĞLU started his campaign by visiting, initially, Mausoleum of Atatürk and Mausoleum of Hacı Bayram Veli in Turkey. After, he went to Yozgat, his birthplace, and Nevşehir to visit Mausoleum of Hacı Bektaş Veli. In order to run his campaign, he visited Trabzon in 4<sup>th</sup> July, Sakarya in 5<sup>th</sup> July, Aydın in 7<sup>th</sup> July, İstanbul in 8<sup>th</sup>, 9<sup>th</sup>, and 10<sup>th</sup> July, Erzurum in 11<sup>th</sup> July, Bursa in 12<sup>th</sup> July, Edirne, Kırklareli and Tekirdağ in 13<sup>th</sup> July, Gaziantep in 16<sup>th</sup> July, Konya in 17<sup>th</sup> July, Kocaeli in 19<sup>th</sup> July, İzmir in 22<sup>nd</sup> July, İstanbul in 23<sup>rd</sup> July, Kayseri in 24<sup>th</sup> July, Diyarbakır in 25<sup>th</sup> July, Antalya in 26<sup>th</sup> July, İstanbul in 27<sup>th</sup> and 28<sup>th</sup> July, Sivas in 31<sup>st</sup> July, Adana and Mersin in 1<sup>st</sup> August, Hatay in 2<sup>nd</sup> August, İstanbul in 3<sup>rd</sup> August, Ankara in 4<sup>th</sup> August, Eskişehir in 5<sup>th</sup> August, Bilecik in 6<sup>th</sup> August, Samsun in 7<sup>th</sup> August, Balıkesir and Manisa in 8<sup>th</sup> August. He had rather meet NGOs and his voters face to face than hold a meeting in contrast to his opponents, wherever he visited.

Being as a joint candidate of the two opposition parties, he gained his votes most in Kırklareli, Edirne and Muğla with the ratios 68,08%, 64,91% and 63,96% respectively, whereas least in Batman, Şırnak and Hakkari with the ratios 1,98%, 2,04% and 2,11% respectively. Diyarbakır is the only province where he could not gain votes. His ranking in Kırklareli, Edirne, Muğla, İzmir, Tekirdağ, Aydın, Mersin, Antalya, Eskişehir, Hatay, Adana, Balıkesir, Manisa is 1<sup>st</sup>, whereas in Bilecik, Ankara, Kocaeli, Nevşehir, Yozgat, Samsun, Kayseri, Gaziantep, Sivas, Trabzon, Sakarya, Konya and Samsun he is 2<sup>nd</sup>. He could not stop the decrease of his votes although he visited the provinces from where he gained his votes most, with respect to his opponents.

Table 8: Ekmeleddin İhsanoğlu's Vote Density in Turkey

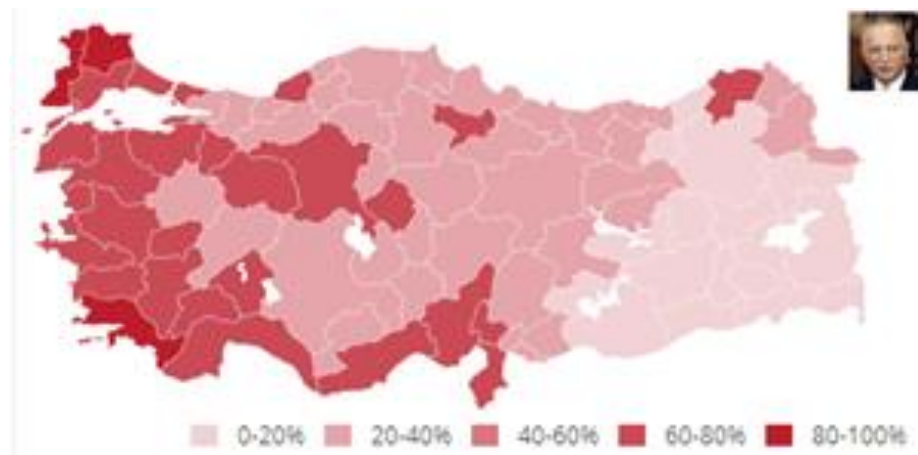


Table 9: Ekmeleddin İhsanoğlu's Election Success in Provinces Run Campaign, The Comparison Analysis of President Election (2014) and General Election (2011)

EKMELEDDİN MEHMET İHSANOĞLU <sup>1</sup>								
THE CAMPAIGN SUCCESS RANKING AMONG PROVINCES	PROVINCE	VOTE RATE %	HIS RANKING OF SUCCESSES	PRESIDENT ELECTION VOTE COUNT	2011 GENERAL ELECTION VOTE COUNT	THE INCREASE NUMBER OF VOTE	INCREASE RATE %	THE CAMPAIGN SUCCESS RANKING AMONG PROVINCES

<sup>1</sup> The yellow-based rows indicates the provinces that the candidate visited during his running.

1	KIRKLARE Lİ	67,98	1	38,31	144488	160359	-15871	-9,90
2	EDİRNE	64,94	1	32,75	156912	176233	-19321	-10,96
3	MUĞLA	63,64	1	31,42	324662	336596	-11934	-3,55
4	İZMİR	58,65	1	25,38	1382320	1421484	-39164	-2,76
5	TEKİRDAĞ	57,19	1	18,99	290959	305004	-14045	-4,60
6	AYDIN	56,31	1	19,55	336768	372024	-35256	-9,48
8	MERSİN	54,49	1	22,45	496576	552979	-56403	-10,20
9	ANTALYA	53,06	1	11,44	584390	660731	-76341	-11,55
10	ESKİŞEHİR	51,94	1	6,52	245453	264844	-19391	-7,32
11	HATAY	51,86	1	7,33	410105	416119	-6014	-1,45
12	ADANA	50,43	1	11,45	541300	617175	-75875	-12,29
14	BALIKESİR	49,62	1	1,50	368593	383325	-14732	-3,84
16	MANİSA	48,26	1	2,11	396755	418627	-21872	-5,22
18	BİLECİK	46,05	2	-4,85	56132	69263	-13131	-18,96
19	ANKARA	45,01	2	-6,15	1238886	1428950	-190064	-13,30
35	KOCAELİ	35,89	2	-22,71	320396	366585	-46189	-12,60
39	NEVŞEHİR	34,18	2	-30,24	55268	62299	-7031	-11,29
42	YOZGAT	33,21	2	-32,57	78514	80353	-1839	-2,29
43	SAMSUN	32,78	2	-33,10	222587	264582	-41995	-15,87
48	KAYSERİ	32,00	2	-34,16	229627	239131	-9504	-3,97
53	GAZİANTE P	29,00	2	-31,46	227967	253787	-25820	-10,17
54	SİVAS	28,80	2	-41,19	101527	108539	-7012	-6,46
55	TRABZON	28,72	2	-41,39	112274	161215	-48941	-30,36
56	SAKARYA	28,64	2	-40,45	144756	177841	-33085	-18,60
64	KONYA	22,33	2	-52,29	247340	296670	-49330	-16,63
68	ERZURUM	18,20	2	-50,72	66115	81964	-15849	-19,34
					8780670	9676679	-896009	-9,26

To sum up, Recep Tayyip ERDOĞAN finished the 'rivalry' first in 56 of the 81 provinces, whereas second in 23 and third in 2. Selahattin DEMİRTAŞ had finished first in 10, second in 5 and third in 66 of the 81 provinces. Ekmeleddin Mehmet İHSANOĞLU was first in 15 provinces, 12 of where are the provinces he visited in his campaign. He was second in 53 provinces, 13 of where are the provinces he visited. He, lastly, was third in the rest of the 13 provinces.

### 3. Conclusions

When the total number of followers of the candidates in social media are compared, it is clear that Ekmeleddin Mehmet İHSANOĞLU reached a number of followers more than his opponents. He, however, couldn't increase his votes as much as his opponents. Another weakness of him is that his personal web page was created only in Turkish. Though it is a positive distinction from the two other opponents that he preferred a face to face communication, he caused a decline in the votes of the two parties -even in the provinces he ranked in first- which stated him as a joint candidate, when compared to 2011 General Elections.

In spite of his negative opinion against Facebook and Twitter before his candidacy of Presidency, he is the first in terms of having followers in these social media instruments. He did not have any visit to five cities where he ranked first, except Konya. His votes, however, declined slightly in Central Anatolia, Aegean, East and Southeast Regions. His votes, also, declined 3,83% by random provinces, likewise there is a ratio of 4,16% decline in the provinces where had visits.

Selahattin DEMİRTAŞ is the candidate who had most sharing in social media instruments with a ratio that is five times more his opponents. He increased his votes in 2014 compared to 2011 in where he visited, but decreased in Şanlıurfa, İstanbul and İzmir although he visited. Although he decreased his votes in İstanbul and İzmir with the ratios 48% and 22%, respectively, in comparison to 2011 General Elections, he increased his votes in where he visited during his campaign. However, the decline in his votes in İstanbul and İzmir shows that there is an overall decline in both random and other provinces he visited, by affecting the average with a ratio of 3,83%.

In conclusion, it can be suggested there is no explicit causality between the number of followers in social media and the results of 2014 Presidency Elections in Turkey. It is, however, remarkable that there is a close relationship between the comment or tweet shared by followers and the votes that the candidates gained in 2014 Presidency Elections. Consequently, it is possible to deduce that political marketing through social media has positive affect on 2014 Presidency Elections in Turkey.

### References

- Bode, L. & Dalrymple, Kajsa E. (2014). Politics in 140 Characters or Less: Campaign Communication, Network Interaction, and Political Participation on Twitter. *Journal of Political Marketing*, DOI: 10. 1080/15377857. 2014. 959686 (accepted but not published paper)
- Divanoğlu S. U. (2008). Seçim Kampanyalarında Siyasal Pazarlama Karması Elemanlarının Yeri ve Önemi, *Niğde Üniversitesi İktisadi ve İdari Bilimler Fakültesi Dergisi*, Cilt: 1, Sayı: 2, 105-118.
- Domenach J M. (2003). *Politika ve Propaganda*, İstanbul: Varlık Yayınları.
- Henneberg, Stephan C. M. (2002). Understanding political marketing. In Henneberg, Stephan C. M. & O'Shaughnessy, Nicholas J. (Eds. ), *The Idea of Political Marketing* (pp. 93 – 158). Westport CT, United States of America: Praeger Publishers.
- Jackson, N. (2005). Vote Winner or a Nuisance: Email and Elected Politicians' Relationship with Their Constituents. *Current Issues in Political Marketing*, (eds: Walter W. Wymer, Jr. , and Jennifer LeesMarshment) *Best Business Books*, an imprint of The Haworth Press, Inc. , 91-108.
- Johansen, Helene, P. M. (2012). *Relational Political Marketing in Party-centred Democracies: Because We Deserve It*. UK: MPG Books Group.
- Kostik Z. (2003): "TSK Asker Hastanesi Yöneticilerinin önderlik Davranışlarının Tespiti ve Sergilenen Önderlik Davranışları ile Kurum Performansları Arasındaki İlişkinin Analizi", Ankara: Gülhane Askeri Tıp Akademisi, Yayınlanmamış Doktora Tezi, Akt. Yıldırım N. (2011): "Eğitim Gönüllüsü Kanaat Önderlerinin Okul yönetimine Katkıları", *Uluslararası İnsan Bilimleri Dergisi*, 8 (2), 879-904.
- Longest, Jr. & Beaufort, B. & Darr, K. E. (1993). Organizational leadership in hospitals. *Hospital Topics*, 71 (3), 11-15.
- Limanlılar M. (1991). Siyasal Pazarlama. *Pazarlama Dünyası Dergisi*, 39 (5), 29-39.

Mc Carty, E. J. (1975). *Basic Marketing: A Management Approach* (5th ed. ). Homewood, IL, United States of America: Richard D. Irwin Publishing.

Miller, William J. (2013). We Can't All Be Obama: The Use of New Media in Modern Political Campaigns, *Journal of Political Marketing*, 12 (4), 326-347. DOI: 10. 1080/15377857. 2013. 837312

Mucuk İ. (1999). *Pazarlama İlkeleri*, İstanbul: Türkmen Kitabevi.

Okumuş A. (2007). Pazarlama Anlayışında Siyasal Pazarlamanın Yeri Ve Pazar Konumlarına Göre Siyasal Partilerin Stratejik Analizi, *Dumlupınar Üniversitesi, Sosyal Bilimler Dergisi*, 17, 157-172.

Özkan N. (2004). *Seçim Kazandıran Kampanyalar*, İstanbul: Mediacat Yayınları.

Qualter, Terence H. (1985). *Opinion Control in the Democracies*. London: Palgrave Macmillian.

Rutherford, P. (2000). *Endless Propaganda: The Advertising of Public Goods*. Toronto: University of Toronto Press.

Towner, Terri L. & Dulio, David A. (2012). New Media and Political Marketing in the United States: 2012 and Beyond, *Journal of Political Marketing*, 11 (1-2), 95-119, DOI: 10. 1080/15377857. 2012. 642748

Üste R. B. , Yüksel B. , Çalıřkan S. (2007). 2007 Genel Seçimlerinde Siyasal Pazarlama Tekniklerinin Kullanımı ve İzmir İli Örneđi, *SDÜ Fen Edebiyat Fakültesi Sosyal Bilimler Dergisi*, 15, 213-232.

### **Internet References**

<http://ihsanoglu.com/>, (E. T. 17. 08. 2014).

<https://sonuc.ysk.gov.tr/module/GirisEkranı.jsf>, (E. T. 15. 08. 2014).

<http://www.haberturk.com/secim/secim2014/cumhurbaskanligi-secimi>, (E. T. 13. 08. 2014).

<http://www.rte.com.tr/>, (E. T. 16. 08. 2014).

<http://www.selahattindemirtas.net/>, (E. T. 17. 08. 2014).

<http://www.sozcu.com.tr/2014/gundem/iste-erdogana-yapilan-secim-bagisi-573957>

<http://www.trtturk.com/haber/cumhurbaskani-adaylari-ne-kadar-bagis-topladi.html>, (E. T. 27. 08. 2014).

Sabah (2012): "Facebook'ta Avrupa Lideriyiz", <http://www.sabah.com.tr/Teknoloji/Haber/2012/01/27/facebookta-avrupa-lideriyiz>, (E. T. 25. 08. 2014).

Social media accounts of the candidates, both in Twitter and Facebook



## Elections and Implementation of the Law of Elections in Albania

Prof. As. Dr. Ilir Berhani

Universiteti i Shkodrës "Luigi Gurakuqi", Shkodër

[berhanijuris@libero.it](mailto:berhanijuris@libero.it)

### Abstract

*After the overthrow of the dictatorial system as in Albania in the year 1990, elections are the only legitimate way for the creation of government. In the new political system pluralist democratic governance based only on general elections, free, equal, and periodicals. It became necessary a series of constitutional and legal regulations for elections and election rights. With new laws were arranged particularly and completely realization of this right. The main legal obstacle to democratic elections was the socialist constitution of 1976. Step immediate legislative, that was taken, socialist constitution was abrogated, in force since 1976 in Albania, and adopted a new basic law, with temporary power, until the adoption of a new constitution, which will be the basis of a new political system which was decided in our country after 1990. The main legal acts arranged elections and election law in the new political system are: first, constitutional normative acts, such include law for "Major constitutional provisions" adopted in 1991, constitutional amendment "On rights and freedoms of man", adopted in 1993 and constitution, adopted in 1998. Second, laws, in the which belong the laws on elections and electoral code adopted in 2000. Thirdly are other normative legal acts that governing the conduct of elections and the exercise of the right of election in the our country. The paper treats the elections as the only way to govern, governments that do not come from elections are considered unconstitutional and not legal. The paper treats the constitutional guarantees for elections and election law. The right of election is considered political fundamental constitutional right, This right is guaranteed by the constitution, is the backup of the constitution and can not be limited or denied to any other normative act. The paper treats the the right adjustments election to election law (Election Code). The Constitution orders that the exercise of the right of election, as constitutional political right, be regulated by a special law. The paper treats the provisions of the electoral code to ensure the exercise of this right policy. The paper also deals with the regulation and protection of the right of election from other legal acts, primarily criminal legislation and administrative. In criminal law prescribes a number criminal offenses that directly protect elections and election law. Place on paper has the jurisprudence of the Constitutional Court and the ordinary courts about the elections and election law.*

**Keywords:** electoral code, the constitution. the right of election, election freedom constitutional justice.

### 1. Elections and Governance

With the political changes in Albania the only way for government ee election. Has no other way tool and to achieve governance New democratic system determines a representative government non government of a class, just like in western democratic systems european and american. In Western Europe and in America governments are representative and realized only through elections. Citizens elect representatives who will govern by voting. In representative government election transformed in a necessary element of governance. Legitimation the governance provided only by elections. "Organization and development the regular elections and free is extremely important moment for the constitution and legitimization of political power. Only through this election becomes possible to broadcast directly political will of the people in the state. For these reasons, the elections are more important and sacred for democracy".<sup>1</sup>

For this reason it was urgent abrogation of socialist constitution, in which the government based not on elections, and represented the dictatorship of the working class.<sup>2</sup> In the new political system, governance is representative of the citizens. It was needed a new constitution to regulate governance. For consistency with urgency was adopted in 1991 Law on "Major Constitutional Provisions" which determined that governing bodies in the country derive from the elections, ranging from

<sup>1</sup> Xh.Zaganjori "Democracy and the rule of law" Tirana, 2002 p. 28-29

<sup>2</sup> Law 7941 dated 29.04.1991 "On the main constitutional provisions" Article 45. ". Constitution RPSSH adopted on 28.12.1976, and its subsequent amendments are repealed."

assembly which is elected by democratic elections.<sup>1</sup> However, a detailed arrangement of the elections and the right of the elections, became the law "On the rights and freedoms" adopted in 1993.<sup>2</sup>

Finally, the role of elections and elections to the government report, in our country, was arranged by the fundamental law of the state, the constitution of 1998. The constitution establishes the elections as the only means political who ensures and guarantees the democratic governance of the country. Legitimate constitutional government based in elections, realized only through freedom equal, general and periodic elections. In this sense, the elections are the only means political for changed the governments in our country. Provision of the Constitution, which regulates election report is with governance, excludes all other means and any other way for the formation of the government in Albania. Government comes only from the elections and there is no other political alternative. The Constitution prohibits any alternative for formation of government and considered unconstitutional any government that does not come from elections.<sup>3</sup> But analyzing this provision conclude that there are not enough for the government to come out of the elections, but only by elections who are freedom. Elections freedom, according to the constitution, means freedom to participate in elections and freedom to choose the most liked alternative governance. With this provision, constitution in way formal legal guaranteeing freedom, elections and prohibits the approval / extraction of legal norms that infringe freedom elections, considering them as unconstitutional. However, the relevant provision foresees that the elections should be equal and prohibits, considering unconstitutional, legal norms that violate equality of citizens in elections. Constitution, with this provision, forcing election laws to guarantee and ensure equal elections, equal value of vote and equal number of votes, for all citizens without exception. Another aspect that sets this provision, means that government comes only from the general election and not by elections partial. General election, with the participation of all citizens with voting rights, and on the entire territory of the country, are the condition that determines provision of the Constitution to form a government. This means that partial elections not constitute reason for the collapse and formation of government in our country. The relevant provision makes and another adjustment for election as a tool of governance. This provision stipulates that government elections must be periodic. And the constitution provides that government elections held in our country every four years, when representative body, the assembly. the mandate ends. So, the constitution obliges our state every four years to hold elections for representative body.<sup>4</sup> The state has a constitutional legal obligation that derives directly from the Constitution, prepare periodically every four years, the holding of elections. With this provision the Constitution does not define a passive position of the state for the elections. Constitution goes in the same direction with the European Convention on Human Rights. The constitutional provision is in accordance with Article 3 of Protocol 1 of the Convention, that legally obliges states Parties to develop elections in reasonable period, determining the Contracting States obligations of positive character to create institutional infrastructures, purpose the realization of the right to vote and the right to be elected to the legislative body. One such obligation / liability is provided by the European Court of Human Rights in the case of Mathieu-Mohin & Clerfayt v Belgium: ". . . First obligation in the relevant field is not simply an abstention or non-intervention, as in most of the rights with political and civil character, but the obligation to take measures with positive character for "holding" of "democratic elections".<sup>5</sup>

In command of the constitution, election law, the election code provides that "Elections are periodic".<sup>6</sup> Like the constitution and electoral code goes in full compliance with Article 3 of Protocol 1 that the election must be made in reasonable intervals. "The High Contracting Parties undertake to organize at reasonable intervals elections . . .".<sup>7</sup> It should be noted that Convention organs not defined and have not fixed this reasonable time interval. But, nevertheless, it is accepted by these bodies to the convention that reasonable time limits can be between five or six years. Another aspect that provision of the Constitution has determined is that the elections for the formation of the governing bodies of the state, should be democratic.<sup>8</sup> With this that provides this provision of the constitution conforms to the standards that define for elections the

<sup>1</sup> Law 7941 dated 29.04.1991 "On the main constitutional provisions" Article 3 pg 3 "Representative bodies are elected by freedom, general, equal, direct and secret vote".

<sup>2</sup> The law "On the rights and freedoms" dated 31.03.1993.

<sup>3</sup> RA Constitution Article 1/3 Governance is based on a system of elections that are freedom, equal, general and periodic.

<sup>4</sup> RA Constitution Article 65/1

<sup>5</sup> Report on the study approach legislation with the European Convention on Human Rights "Tirana 2003 f..55

<sup>6</sup> Electoral Code 2008 Article 3/1

<sup>7</sup> Protocol 1 ECHR Article 3. "The High Contracting Parties undertake to hold freedom elections at intervals reasonable by secret ballot, under conditions which ensure the free expression of the opinion of the people in the choice the legislature".

<sup>8</sup> Constitution Article 1/3

European Convention and Article 3 of Protocol 1, wheredetermined that "Parties . . . undertake to organize . . . freedom elections by secret ballot, under conditions which will ensure the free expression of the opinion of the people . . ."<sup>1</sup>

## 2. Right of election is a constitutional right

Based on the provisions of the constitution electoral rights, includes in its content both right; the right to vote and the right to be elected to representative bodies and government.<sup>2</sup> In the specific provisions in the constitution are directly regulating the right to vote and be elected. Moreover, the constitution defines the right of election as a fundamental political right of every citizen, which provided and protected by the constitution. The Constitution contains provisions that oblige the state and state bodies to respect the constitutional right of election. These provisions oblige the state and state bodies approve acts and oblige them to act to ensure the realization of this right by the citizens. In this sense, the state has a positive legal obligation not only to respect the right of citizens, but also the obligation to adopt laws that regulate and protect the realization of this right.<sup>3</sup> The right to vote is a right ". . . to which public power authorities in fulfilling their duties, must respect . . . and to contribute to its realization"<sup>4</sup> Protocol 1, Article 3 not only considers the right of voters a fundamental political right, but is among the few provisions which establish a positive obligation for the state. However Protocol gives freedom to each state to choose the electoral system and to determine the representative body. Even the European Convention on Human Rights only in this provision clearly involves only basic political right. . In this direction in our constitution the right to elect is defined as a general right, as the right of all citizens, that fulfilled two conditions are citizens and have reached eighteen years, including on election day.<sup>5</sup>

The right to elect and be elected has every citizen. But defining the right election as a general political right of citizens our Constitution places a restriction on the electoral rights age limit, eighteen years. Constitution considers reserve of the constitution determining the terms of the possession of the right to vote, citizenship and adulthood. However, the constitution considers constitutional reserve the prediction of cases that restrict or prohibit the development and implementation of the right of election. The Constitution has provided only two cases of prohibition or restriction on the right to vote (mental incapacity declared by a court decision final) pg 2; and removal of personal freedom, imprisonment (persons deprived of their liberty and are suffering sentence of imprisonment who, according to the constitution, in this provision, owning only the right to vote, pg 3).<sup>6</sup> Even in this aspect the constitution is approximated with the European Convention on Human Rights. Restrictions of this type are provided and permitted and under this Convention. The European Convention provides that states have the space to set conditions for the exercise of this fundamental political right of citizens. In this direction, the European Court of Human Rights, in its decisions, has accepted limitations of the election right. The Court has recognized that states parties have wide margin of appreciation in this field. However, it should be noted, however, that the European Court has not adopted a closed list, to limit or derogate from this right subjective.<sup>7</sup> In the spirit of the Convention and the decisions of the European Court and of the constitution, the Electoral Code provides that, "All albanian citizen who has turned 18 years old on election day and that meets the necessary requirements in this code has the right to vote in elections for parliament and local government bodies"<sup>8</sup> The right, the citizens to elect and to be elected, is a fundamental political right of citizens double. It includes the right to vote for the election of representatives and also includes the right to elected in functions public and state functions.<sup>9</sup> Based on what is provided for in the constitution, it follows that restrictions of right of election that overcome the limitations provided for in the constitution considered unconstitutional. Restrictions, over constitutional reserve, become the subject of constitutional adjudication by the Constitutional Court and abolished. Election laws and all other normative acts for elections must guarantee the right of

<sup>1</sup> Protocol 1<sup>1</sup> of ECHR. Article 3

<sup>2</sup> Kushtetuta neni 45/1

<sup>3</sup> Assembly on the implementation of the constitutional obligation approved KodinZgjedhor, in 2000, amended in 2003,2008,2012

<sup>4</sup> Report on the study approach legislation with the ECHR "Tirana 2003 f.56

<sup>5</sup> RA Constitution Article 45/1

<sup>6</sup> Report on the study approach legislation with the ECHR "Tirana 2003 f.57

<sup>7</sup> Report on the study approach legislation with the ECHR "Tirana 2003 f.56.

<sup>8</sup> Electoral Code 2008 Article 3.1

<sup>9</sup> RA Constitution Article 45/1 "Every citizen ... has the right to elect and be elected. "

election in two aspects: in terms of the right to vote and in terms of the right to elected. Because restriction of the right of election are the reserve of the constitution, and the constitution is the highest normative act in the legal hierarchy, the constitution has provided cases of violation of this or restricting the right of election. So, the right to elect is a fundamental right political constitutional of individual. This right can not be violated by law and for consistency no individual is excluded from the possession of right to vote. However, the Constitutional Court of Albania and the European judicial practice acknowledged and considered justified the imposition of restrictions on the realization of the right of election, such as age, place of residence and registration on election lists. This means that citizens to realize the right to vote, to vote in elections is not enough to be eighteen years old, but must be registered in voter lists and to vote in person at their residence stable.

### 3. The implementation of the right of election

Albania has adopted legislation comprehensive and democratic, in level standards prescribed and delivered in Europe and in other democratic countries, which constitutes the legal basis necessary for recognition of the right to vote to all citizens and regulating the legal side, so a detailed and the realization of the right of election as the main political rights. Normative legal base to ensure legally vote, election rights, are kuahtetuta, electoral code and laws and other acts. Moreover, in international reports on the elections held in our country during the period 1991 -2015 election normative basis is identified from internationals as an aspect of the achievements made by Albania towards approximation its legislation in the field of elections with international law in general and in particular with the European legislation. By underlined this aspect reporters OSCE / ODIHR have affirmed that the elections are regulated by a comprehensive legal framework, including mainly the Constitution, amended for the last time in 2008, and the Electoral Code of 2008, amended for the last time in July 2012. This legislation, of european standards, constitutes, in this way, the necessary normative, formal legal for democratic elections. Other laws applicable to elections include the Law on Political Parties, Meetings Law and the Penal Code, the Code of Administrative Procedure and the Code of Civil Procedure, which apply, respectively, in the proceedings of election commissions and courts, and the Law on Gender Equality containing provisions which ensure equal gender representation in election administration bodies and in parliament.<sup>1</sup>

But, however, the implementation of the right to vote in our country has experienced a series of deviations, which has brought as a consequence negation infringement and violation of the right to elect, in both aspects, as the right to be elected to representative bodies and right to vote. The main consequence that is derived from these deviations has been distorting the results of the elections or manipulation of the results of the elections. For these reasons, in many cases, the representative body elected at the conclusion of the election process, not reflected correctly and adequately map, or political geography of the country.<sup>2</sup> Because elections are the way, are the only means constitutional and legal for the coming to power of political forces, The main political issue for parties, since installing the new political order, became and remained elections. For these reasons, the parties have used all legal and political means to acquire them. However, this brought to consequence that elections to be and issue more fragile in new political system. Consequently, political parties, given that they are the main subjects the election, used from the beginning and even today use highly legal and illegal machinations to win the elections. Election Wins is also win of power, government victory. Legal and illegal machinations used by the parties in elections often have been violating election, and, violating the electoral outcome, bringing in governance not real election winners.<sup>3</sup>

### 4. Violations of right of election

Elections was made one coveted issue for all political parties were created in our country after allowing political pluralism.<sup>4</sup> Parties to come to governance should win the elections. Consequently, the political struggle to win elections

<sup>1</sup> Raporti i OSBE / ODIHR 2013 "Për zgjedhjet në Shqipëri".

<sup>2</sup> Megadushku in 2001 elections and manipulation of elections in 2009

<sup>3</sup> Raport për zgjedhjet e 1996

<sup>4</sup> On December 12, 1990 was created the first opposition party in Albania after the full 45 years, the Democratic Party (DP). Creating PD was followed by other parties that were created after the announcement on 15 December 1990 by the decree of the President of the Law "On political pluralism". was established Republican Party (RP), Ecological Party and Omonioia a political organization of minorities in Albania.

presented harsh. Furthermore, parties seeking at any cost come to power using any form and means to win elections. Tools and forms, which are used by political parties to manipulate and violated elections in our country are different. But, in the paper treated just some ways, forms the tools more frequent and more identified, violations that have affected more in deviation and violation of this right. One form applied in almost all elections held in our country is not giving citizens in time of identification documents. Without documents of identification citizens, even though they are eighteen years of age and have the right of election, can not exercise their right to vote, so can not vote in elections. Citizens, which for lack of identification documents, can not vote, were not negligible, but have been a significant number that has always influenced the outcome of elections. By highlighting this form of violation of the election, as one of the most visible forms that marred the elections. report of OSCE ODIHR, for 2009 elections in our country, outlined in its content that . . . most significant debate in the general election of 2009, politically, was connected with delivery of ID cards. Were declared data with numbers, but the inaccuracies in these data prompted the opposition to accuse the government for intentional manipulation. This issue was further complicated because the discretion of the Ministry of Interior, from 729. 020 citizens without a passport, about 160,000 to 260,000 were abroad without valid documents. On election day, were not processed only 3. 321 applications submitted by 1,402,361; 77. 751 new identity cards were not withdrawn. 256. 792 citizens, who were registered in the database of persons without a valid passport, did not apply for a new identity card. There is a significant discrepancy between male and female citizens, especially among those aged from 21 to 50 years. It is likely that many women who are married and have changed their surname, to remain registered in local registers with Their surname of maiden, therefore listed twice . . . . Over 2,000 voters with disabilities who do not have valid passport, could not apply for a new ID card, due to access difficult or impossible in application centers. <sup>1</sup> The conclusion was evident that, in the elections of 2009, a significant percentage of citizens can not vote, because it did not possess a passport or an identity card.

The electoral code provides that the right to vote is personal. Code obliges citizens with voting rights vote personally. Provisions of the electoral code. that regulates the exercise of the right to vote, obliges a citizen to vote himself. According code citizen votes by being personally present at the polling station. But the electoral code provides that voter comes only once in the voting center, and that the elector enters only in the secret booth where he votes. Zgjesësi is obliged to vote in secret, votes liberated from any influence. Based on the election code it's violation open ballot and vote for other people. Election Code provides only one way to exercise the right to vote, the elector must be present to vote at the polling station and voter votes only. " . . . the voter enters only in the secret booth . . ." <sup>2</sup> . . . the voter votes only for himself . . . " <sup>3</sup> To ensure personal vote, Code provides criminal responsibility for members of the Voting Center Commission, if they allow a voter to vote more than once . . . " <sup>4</sup> In international relations for elections are identified many forms that are used and violated directly personal character of the vote, as family voting and voting on behalf of others. . . . International reports, highlighting this aspect, underlined that serious problems are, wide spread of family voting, voting on behalf of others, all cases where the voter lists had seemingly similar firms, the same person who "helps" more than one voter, attempts to influence voters, and pressure on voters or on election officials. . . " <sup>5</sup>

Ways more evident with influence direct in election result has been the manipulation of election results during the counting process. In many cases are excluded from the count voting centers, and are not included in the final result with various pretexts. One such case was identified in the 2001 elections. Central Election Commission ordered not included in the final result four polling stations in a electoral zone. This was in violation of the constitution and the electoral code, guaranteeing the right to vote and ensure its exercise and consideration and count each vote. Order of the Body Central Election was appealed to the constitutional court. The Constitutional Court decided the repeal of the order by ordering the counting of votes in these electoral centers. Arguing the decision Constitutional Court notes that the electoral code guarantees count each vote and obliges electoral bodies to counted in determining the election outcome of all votes in each constituency and in every polling station, not allowing these bodies on this aspect to exclude the counting of votes in any polling station. <sup>6</sup> From reporters OSCE / ODIHRIT, for 2003 local elections, reported a negative evaluation of the

<sup>1</sup> Report OSCE - ODIHR 2009

<sup>2</sup> Electoral Code 2008 Article 101/1

<sup>3</sup> Electoral Code 2008 Article 101/3

<sup>4</sup> Electoral Code 2008 Article 101/4

<sup>5</sup> Final report of OSCE / ODIHR in 2013 elections.

<sup>6</sup> Decisions of the Constitutional Court "Electoral Process 2001" f.161. Decision No. 111/01. With this decision, this court considers unconstitutional decision dated 08.08.01 nr.219 CEC with which he was ordered not to be included. With this decision, this court considers unconstitutional decision dated 08.08.01 nr.219 CEC with which he was ordered not included in the final result table of the area 82, four

counting process in 38 percent of polling stations where the count was observed. While 43 percent of polling stations, where observers were present, were reported significant procedural errors and enough deficiency. <sup>1</sup> Deficiencies in counting and manipulation of results in the counting process was repeated in the general election of 2009. According to the final election report, presented by the OSCE / ODIHR, According to the final election report presented by the OSCE / ODIHR, the ballot counting was rated bad or very bad in 22 places Counting of votes from 66 such that were total of. <sup>2</sup> This was the distortion of election results in the 1/3. According to this data the vote is violated, and the result is 33 percent of manipulate. In this case, the right to vote has been violated clearly. However, although it seems quite strange, elections were considered regular and the result was certified, but only from one side of. The opposition did not accept the results of the general elections of 2009. The election result was rejected as the manipulated throughout legislature. For this reason, the opposition boycotted the proceedings of the representative body to the time limit, set by the constitution, in loss of representation mandates.

Another way of repeatedly of the violation of the right to vote in elections is a violation of the secrecy in voting, although the Constitution establishes that the vote is secret and citizens enjoy the freedom to vote. Election observers in our country identified several cases of violation of secrecy in voting. Report OSCE / ODIHR in the 2009 elections, found that 9 percent of the centers surveyed, not guaranteed secrecy of the vote provided in Copenhagen Document of the OSCE, mainly because not good space planning, limitations of this space, or the large number of people. At 2 percent of polling stations that were observed, not all voters marked a ballot inside the cabin and in 4 percent of the centers visited, not all voters folded their mark sheet, in order to ensure the secrecy of the vote. Another way of the violating the secrecy of the vote, which was highlighted was the family voting. Report OSCE - ODIHR underlines that family voting was reported by 19 percent of polling stations observed. Other ways that violated the secrecy in voting that were found were: voting on behalf of others (3 percent), attempt to influence voters (4 percent), cases where the same person "helping" more than one voter (4 per cent), pressure on election officials or voters (1 percent), as also similar firms in the list of voters (4 percent). <sup>3</sup> However, the report notes that election administration bodies made no legal proceedings to remedy these violations. Even political parties did not appeal to the court for the violations occurred. This is explained by the fact that all political parties participating in elections, violate the secrecy of the ballot itself, but also because subjects did not believe that the judicial process can be transparent and non-suggestible by the parties. In connection with this fact, international election reporter revealed that . . . although were identified ways and diverse forms that violated secrecy of the vote, not observed frequent processes and numerous judicial processes to restore this right by all these forms of violating the election law. Not developed with trials necessary adjustments which to respect the secrecy of voting in elections. <sup>4</sup> Repeat form of the violation of the right to vote that is recorded is falsifying the election results.

Form of repeated of violation of the right to vote that is recorded is falsifying the election results. The reports of the OSCE / ODIHR election, is evidenced by the observers, the falsification of the results of voting in some polling centers or some counting sites. According to the report, in 2009 elections reported level of different of falsification of results in 10 percent of polling stations. <sup>5</sup> So, the outcome of the election was distorted and unrealistic. But, although is falsified, result remained such, because result, was not subject to judicial control. judicial Review of election results in this case, remains the only legal instrument that finds deformations and has the legal right to correct them. This is in line with European court decisions. The European Court has determined that, far country court to investigate and determine, in each case, infringement and violation of this right. Moreover, the court is the body that decides case by case also the legality of the deprivation and restriction of the right of election.

Other forms of violation of the right of election, even, and most frequently are manipulating national registry of voters and failure to register of citizens in lists of voters. These violations are repeated in all the elections held in our country.

---

polling stations. The Constitutional Court found that the CEC is out of power and ... has violated the constitutional right to vote ...of voters of these polling stations ... which speaks to Article 45 of the Constitution..

<sup>1</sup> The OSCE / ODIHR in the 2003 election

<sup>2</sup> The OSCE / ODIHR in 2009 elections

<sup>3</sup> Final Report the OSCE / ODIHR in 2009 elections

<sup>4</sup> Final Report the OSCE / ODIHR in 2009 elections

<sup>5</sup> Final Report the OSCE / ODIHR in 2009 elections

Forms used to manipulate voter register are: **a-** failure to register in the register of persons who have reached voting age;<sup>1</sup> **b-** duplicate registration of some citizens; **c-** in the voter exclusion of citizens who enjoy this right; **d-** not equipping of citizens with identification documents: passport or ID card; **e-** the relocation of voters from the voter list unit the residence in a list that belongs to another electoral area; **f-** not announcement the voters for their place in the list of voters and their voting center; **g-** inclusion in the voter list of individuals that have not identified residence; **h-** included in the voting list of persons who are not residents of the polling area.

Failure to register the voters in the voter lists, the voter owns this right and the removal of voters from the voter list, when the voter should be in these lists are arbitrary actions not based on law. This violation of election officials, it is difficult and very complicated to prove and interpret, but brings a serious legal consequences, removes voters right of the election, which gave voters the constitution and electoral law guarantees. To take this decision the administration of the election officer does not own any discretionary powers. Legal cases for non-registration of voters on election lists and removing voters from voter lists are defined in the law. Electoral officer has no discretion but to make decisions based on determinations made in the law and in the documents, sent by other entities with which he proceeds to prove the loss of the right of election, or not to register on the list. Opportunity to remove voters from the voter lists is when the voter loses citizenship. The other case is when electoral office takes into consideration documents proving the non-existence of the citizens in civil status register resident citizens, In this case the electoral office did not record the name of the citizens in the lists of voters who are resident in the electoral district. Reason is that election law provides that voters register only on election lists of residence, or the country where they are resident enrolled in the civil registers. In both cases reviewed above is presumed that other offices documentation submitted is correct and true. To protect the exercise of the right of election the violations that affect law of the election, as irregularities in the voting process, voting more than once, pressures during voting, vote buying by candidates or political parties and the sale of the vote by the voters, the election code provides specific provisions that define criminal and administrative punishments.

The right to vote is determined in special constitutional provisions and protected directly from it. It is part of the basic human rights guaranteed by the constitution. This right finds protection in election code, which has provided some offenses punishable, which can be performed by state bodies governing administer elections, election administration and individuals. In a chapter electoral code defines responsibilities and sanctions for persons charged with the administration of elections.<sup>2</sup> Such acts are: abandoning of duty by members of the election commissions.<sup>3</sup> In the code are also provided administrative sanctions for actions that do not constitute a criminal offense or abuse of power under Article 248 of the penal code,<sup>4</sup> which are defined as administrative violation, where not affect the outcome of elections, and are considered a criminal offense, when these actions affect the outcome of elections. In this case provided imprisonment from 6 months to two years.<sup>5</sup>

But the violation of the right to vote is protected not only with the provisions of special of the Electoral Code, but also by providing penal code provisions that provide for offenses against elections. The penal code provides criminal acts that violate the election: prohibition to vote; voting more than once; manipulation of election results,<sup>6</sup> obstruction of subjects for elections to representative bodies; falsification of documents and election results; violating the secrecy of voting; giving of

<sup>1</sup> In the doctrine of law has two views: 1. The voter lists are a basic act, 2. shkrimi on these lists it's with declarative character and not the founder. Today, the doctrine of law, presented as the dominant viewpoint that the right of election arises from the qualities and conditions set directly by the constitution and the electoral law and the holding this right is not related at all with the inclusion of voters in the election lists. The holder of the election right guarantees this right without even being written in voter lists with a declarative decision rendered by the court. Inclusion on the electoral lists is only necessary and sufficient to exercise the right of choice, Excluded are special cases of voters who exercise this right without being registered in these lists. This refers to the exercise of the right of election by people who have not yet completed the age set by law It is the case of persons who acquire the legal capacity to act before the age prescribed by law. (Married women). Or in the case of persons who are permitted to exercise the election right of a judicial decision or a decision of the local authority.

<sup>2</sup> RA Electoral Code Electoral Code Article 168 ". Members of election commissions and employees of the public administration at the service of these commissions hold criminal and administrative liability under the legislation in force for violations of the provisions of this code".

<sup>3</sup> Neni170 Electoral Code "... criminal offense punishable by a fine / imprisonment 6 months to 2 years".

<sup>4</sup> Electoral Code Article 171.

<sup>5</sup> Electoral Code Article 172.

<sup>6</sup> RA Criminal Code Chapter X

---

rewards and promises; intimidation of the voters and candidates; violation of the right of election. <sup>1</sup> Problem controversial it's case the punishment of individuals with prohibition of the right to exercise the duties as a civil servant or public service. <sup>2</sup> and the removal of the right to practice profession or activity. <sup>3</sup> It seems clear that the removal of the right to exercise a profession or activity in the sense of the Article 30 paragraph 5, differentiate from the prohibition constitutes an obstacle to public functions as defined in Article 30 paragraph 1 of the the Criminal Code. Prohibition the possibility to exercise public functions may lead to the removal of the active electoral right. . In this case the law may be provided obstruction of citizens to run for election and to exercise the function of legislators or other public functions acquired through elections.

But the election law has not defined any prohibition for citizens who have besides the main sentence as accessory punishment prohibition of the exercise of public functions that accessed through elections. Just constitution restricts active right election, citizens sentenced to imprisonment by a final decision, who are serving a sentence. In this case, the constitution provides that the implementation of the main sentence prevents directly election of citizens in representative bodies. For this reason it is not envisaged in the Election Code, such a restriction. But in this case, by sending the decision by the court, election administration does not accept the registration of citizens in the lists of candidates. There are states where citizens lose the right election because even moral unworthiness determined by law. These persons are excluded from the right to elect. <sup>4</sup>

## Conclusions

By addressing the issue can be concluded that in our country there is proper legislation regarding elections and guaranteeing the right of election, constitution, electoral code, and laws and other legal acts, which constitute the legal basis governing elections. From paper comes out that legislation is in full compliance with international norms for the elections, the European Koneventën Individual Rights and its additional protocols. Another finding indicates that elections in our country have presented many problems. In elections are observed violations of election law and a violation of this right in the way of different forms. For this reason during this period are made constantly attempt to adjustments in the legislation on elections. The most important adjustment for elections was the adoption of the constitution in 1998 and adoption of the Electoral Code in 2000. in elections held in our country are observed significant cases of violation of the right of election, which quite times have brought about the worthlessness of the elections, the case of general elections of 1996 and the distortion of election results. Constantly it's improved election legislation based on the recommendations of international organizations monitoring the elections in Albania, OSCE and ODIHR. But the last election proved the need for other changes to the electoral code, which would guarantee election truly democratic and free elections.

## Bibliography

1. Raporti OSCE ODIHR for the 2003 local elections.
2. OSCE ODIHR report on the general elections of 2009
3. OSCE ODIHR report on the general elections of 2013
4. The Code of Good Practice in Electoral Matters. Strasburg. Tetor 2002
5. L. Omari, A. Anastasi "Constitutional Right" Tirana 2010
6. Luan Omari "Rule of law" Tirana, 2002
7. Aurela Anastasi "The constitutional right of comparing" Tirana 2009

---

<sup>1</sup> RA Criminal Code Article 331.

<sup>2</sup> RA Criminal Code Article 30, 1.

<sup>3</sup> RA Criminal Code Article 30, 5.

<sup>4</sup> The Constitution of the Italian Republic Article 48. "The right to vote can not be restricted except for civil incapacity or as a consequence of the a criminal decision final and in cases of moral unworthiness established by law".



- 
8. Xhezair Zaganjori "Democracy and the rule of law" Tirana, 2002
  9. Xh. Zaganjori, A. Vorpsi, D. Biba "Constitutional principles and fundamental rights in the jurisprudence of the Constitutional Court" Tirana 2012
  10. Ilir Berhani "Fundamentals of election law" Tirana 2009
  11. The Constitution of RA 1998
  12. Election Code 2008,2012
  12. Election Code 2008
  14. Legal Studies Nr. 2 Tirana 2004
  15. European Convention on Human Rights.
  16. Additional Protocol 1 ECHR
  17. The Constitution of the Italian Republic
  18. Report on the study of approximation of legislation with the ECHR "Tirana 2003
  19. "international protection of human rights" OSCE-ODIHR Tirana 2000
  20. The judicial decisions of the European Court of Human Rights, Tirana 1998

---

## Cultural Specifics of Life Values and Subjective Well – Being

Elena Chebotareva

Ph. D. , Associate professor

Peoples' Friendship University of Russia

[chebotarevy@yandex.ru](mailto:chebotarevy@yandex.ru)

### Abstract

*The objectives of the study were to reveal cultural specifics of modern life values and subjective well-being, individual and cultural values interrelations, life values and subjective well-being correlations at Russian residents, belonging to different religions. The main methods were Scales of: Value Orientations Actual Structure (Bubnova), Psychological well-being (Ryff), Life Satisfaction (Neugarten, Havighurst, & Tobin), Subjective Happiness (Lyubomirsky & Lepper), Student's T-test, Spearman's rank correlation. The sample consisted of 330 persons (18-55 years old) of 10 different nations and 5 religions. By the time of the survey all the participants had lived in Russia for some (not less than 3) years. For each studied religious groups their dominant life values were revealed. It was discovered, that people of different cultures associate their well-being and lives satisfaction with different life values. However, in general, life satisfaction correlates with those values, which are less important for certain culture. Perhaps, persons, oriented on traditional and culturally important values are less happy than those, who are oriented for their individual ones. May be in assessing realization of individual values people use their own criteria, which are not as strict as criteria of common cultural values' realization. The results of this study allow us to draw the following conclusions. Significant cross-cultural differences in life-values and subjective well-being have their sources in religious attitudes and settings. People of different cultures associate their well-being and lives satisfaction with different values. Generally, well-being and life satisfaction are directly related to the values, less important in certain culture.*

**Keywords:** Life Values, Subjective Well-being, Cross-Cultural Differences, Life Satisfaction, Religion.

### 1. Introduction

The last decades' practice of the intense intercultural contacts in different places of the world shows that the different nationalities and religions peaceful coexistence is impossible without understanding and respecting of each other worldviews and values. Ignoring of cross-cultural worldview differences lead to ethnic and religious tension and hostility. It is important in cross-cultural studies to take into account the mutual influence of different cultural factors, such as ethnicity and religion, country of residence and so on. Again, generalization of the studies of social tension, tolerance, social distance, cultural conflicts shows that people feel tension in intercultural contacts when they perceive the situation as threatening their well-being. (Chebotareva, 2014 a-d).

Subjective well-being (SWB) has become one of the most popular subject of psychological research over the past decades (Diener et al, 1999). Currently, it is common to identify two components of subjective well-being: affective and cognitive. The affective component is considered as a hedonic balance (balance of pleasant and unpleasant affects). The cognitive component is understood as a person's evaluations of his or her life according to some standards. Such standards are primarily linked by researchers with the culture in the broadest sense of the notion.

Many researchers proved that both components of SWB are influenced by personality (Diener et al, 1999) and by culture (Diener & Suh, 1999), but most studies considered personality and culture in isolation, although they often recognize the mutual influence of these two factors. U. Schimmack and others (2002) state that conjoint investigation of personality and cultural SWB determinants has the advantage of identifying possible interactions between personality and cultural variables. For example, in their research they demonstrated that self-esteem was a stronger predictor of life satisfaction in individualistic cultures than in collectivistic cultures because individualistic cultures emphasize a positive self-view; they also showed that the influence of extraversion and neuroticism on life satisfaction was moderated by culture (Schimmack

et al., 2002). Oishi, Diener, Lucas, and Suh (1999) found that freedom was a stronger predictor of life satisfaction in individualistic cultures than in collectivistic cultures.

The studies of SWB and culture interaction showed that culture influences SWB directly and indirectly. There are a lot of evidences that people in individualistic, rich, and democratic cultures have higher levels of SWB than in collectivistic, poor, and totalitarian cultures (Diener & Suh, 1999; Veenhoven, 1993). Besides, culture moderates the relation between hedonic balance (important aspect of SWB) and life satisfaction. For example, it was demonstrated that the relation between hedonic balance and life satisfaction was significantly stronger in individualistic cultures than in collectivistic cultures (Suh et al., 1998). SWB in individualistic and collectivistic cultures is determined by the fact that individualistic cultures emphasize individuals' needs and freedom of choice, whereas collectivistic cultures emphasize others' needs, duties and reliance on one's fate (Triandis, 1995). Luo Lu proved that culture-specific modes of self-construction lead to the diverse meanings people hold for happiness and well-being in different societies. In particular, the author said that subjective well-being for the Chinese was construed around fulfilling one's obligations and maintaining homeostasis (dialectical balance). In contrast, modern Western individual-oriented view of the self was related to understanding happiness as "a prize to be fought over, and entirely one's responsibility to accomplish this ultimate goal of life" (Lu, 2008, 290).

Therefore, culture serves as a major force determining the way people conceptualize the self, understand happiness, set life-goals and select strategies of the goals achieving. That value orientations can be seen as a mediator between culture and personality, one's outlook and one's life esteem. Value orientations are the results of the social relations reflection and system-forming factor of personality. As the values serve phenomena of reality, significant for an individual, including public relations. Most studies have focused on the question, how subjective well-being and life satisfaction can be modeled by cultural values (Schwartz & Bilsky, 1990; Schwartz & Bardi, 2001; Schwartz et al., 2001).

Many researchers to reveal the relations between life values and SWB actively used Schwartz values paradigm (Sagiv and Schwartz, 2000; Hofer et al., 2006; Joshanloo & Ghaedi, 2009; Cohen and Shamai, 2010; Bobowik et al., 2011). L. Sagiv and S. H. Schwartz (2000) showed that SWB was directly related the values of stimulation, self-direction, achievement, benevolence and universalism; and inversely – to the values of conformity, tradition, security and power. M. Bobowik et al. (2011) found in European population direct relationship between SWB individualistic values and inverse relationship between SWB and values of power and conservatism and other more collectivistic values. J. Hofer et al. (2006) reported similar results concerning value of benevolence for persons originating from Germany, Costa Rica and Cameroon. A. Cohen and O. Shamai (2010) in Israel also found direct relations between SWB and the values of benevolence, self-direction and achievement; and inverse – between SWB and the values of power and tradition. M. Joshanloo and J. Ghaedi (2009) discovered in Iranian population positive relation of SWB with value achievement, and negative – with value of tradition

A number of empirical studies proved promising approaches to the SWB study in relation with the life values and their cultural specifics (Oishi et al., 1999; Yetim, 2003; Pienaar et al., 2006; Lu, 2006; Vansteenkiste et al., 2007; Georgellis et al., 2009; Welzer & Inglehart, 2010; Joshanloo, 2010; Huta & Ryan, 2010; Yang and Stening, 2012).

S. Oishi and others found that life satisfaction was more strongly related to financial satisfaction to in poorer nations, and – with home life satisfaction in wealthy nations; with esteem needs - in individualist nations, than people in collectivist nations (Oishi et al., 1999).

It was proved, for example, that at Spanish adolescents overall satisfaction with life was positively correlated with non-materialistic values (Casas, et al., 2004). Across countries study by these authors revealed the direct relations between Life satisfaction and values of benevolence and hedonism values, and inverse relations between life satisfaction and values of power and security. But they also discovered the differences in the nature of links between countries with high and low Human Development Index (HDI). In particular, the value of achievement was positively related to life satisfaction in low HDI countries, but negatively in high HDI countries (Casas, et al., 2004).

Therefore compilation of the data from different empirical studies lets us to reveal not only cultural specifics of the nature of SWB and life values interaction. The main conclusion is that the dimension of collectivism - individualism is an important factor defining life satisfaction level and understanding of well-being in different cultures. But by now not enough studies of different cultures have been accumulated in order to be able to deduce some universal laws. Moreover, most cross-cultural

studies were conducted with representatives of different countries or with emigrants and locals. We consider it is important to study how the values of the culture of origin correlate with subjective well-being of residents of one country.

## 2. Method

### 2.1. Participants

The empirical study sample consisted of 330 persons (18-55 years old) of 10 different nations (Russian, Ukrainian, Byelorussian, Armenian, Georgian, Azerbaijan, Tatar, Uzbek, Tajik and Jew). Among the participants there were representatives of 5 religions: Orthodox Christians (90 persons), Catholics (44), Muslims (65), Buddhists (71), Jews (60). All the religious groups were aligned by gender and age. The respondents were not very religious, but they were brought up in the spirits of their religions. By the time of the survey all the participants had lived in Russia for some (not less than 3) years.

### 2.2. Materials

Personal information form consisted of questions about gender, age, profession, country of origin, nationality, religion, period of stay in Russia.

"The Scale of Value Orientations Actual Structure" (Bubnova, 1999) measured the participants' life values. The technique is aimed at studying the implementation of the person's value orientations in real life conditions. It includes 66 closed questions, distributed on 11 scales reflecting the generalized value orientations: pleasant pastime, high material well-being, enjoying beautiful, help and compassion for others, love, cognition of nature and human, high social status, recognition, respect and influence on others, social activity in order to achieve positive changes in society, communication and health.

Subjective well-being was estimated by 3 techniques "Scales of psychological well-being" (Ryff, 1989, adapted by Shevelenkova, Fesenko). The inventory consists of 84 statements reflecting the six areas of psychological well-being: autonomy, environmental mastery, personal growth, positive relations with other, purpose in life and self-acceptance. Indicators of different scales are combined into three integral indicator: affect balance, meaningfulness of life, openness to the world.

"Life Satisfaction Index-A" (LSI-A)" (Neugarten, Havighurst, & Tobin, 1961, adapted by Panina) measures the overall psychological state of the person, which is determined by the personal characteristics, the system of one's relations in various life aspects. It consists of 20 questions; the results of the responses are reduced to 5 scales characterizing different aspects of the person's life satisfaction. These include zest (as opposed to apathy), resolution and fortitude, congruence between desired and achieved goals, positive self-concept and mood tone. The persons showing high scores on the questionnaire, usually take pleasure in their daily activities, find their life meaningful, and have feeling of success in achieving major goals, positive self-images and optimism.

"Subjective Happiness Scale" (Lyubomirsky & Lepper, 1999, adapted by Leontiev, 2000) is the express (4-item) scale, designed to assess the current psychological state of the person. It shows a subjective assessment of whether one is a happy or an unhappy person.

### 2.3. Procedure

The procedure of the research was approved by the Department of Social and Differential Psychology of Peoples' Friendship University of Russia (PFUR). We used snowball sampling method: first members of international research group recruited the subjects from their acquaintances working in different spheres, then these people recruited their acquaintances and so on. The surveys were conducted personally during 2-3 meetings, 30 minutes each. All the

participants were informed by the researchers about the aims of the study before the measures were administered. For obtained data analysis we used statistical techniques: Mann — Whitney U-test, Spearman's rank correlation coefficient.

### 3. Results

#### 3.1. General characteristics of life values and subjective well-being.

Table 1 presents the significance degrees of life values for different cultures representatives.

Table 1. *Cross-cultural peculiarities of life values*

Life values	Orthodox Christians		Catholics		Muslims		Jews		Buddhists	
	M	St. D.	M	St. D.	M	St. D.	M	St. D.	M	St. D.
Recreation	3,949	1,38	4,750	1,29	3,965	1,45	3,714	1,84	3,676	1,61
Material prosperity	3,318	1,47	3,250	1,96	3,544	1,54	3,643	1,59	3,270	1,82
Enjoying beautiful	3,749	1,54	4,083	1,73	3,491	1,68	3,857	1,41	4,459	1,48
Charity	4,308	1,32	3,750	1,96	4,649	1,38	4,536	1,45	3,946	1,96
Love	3,882	1,46	3,417	1,73	3,719	1,22	4,036	1,57	3,865	1,53
New knowledge	3,492	1,49	3,250	1,76	3,491	1,36	3,464	1,64	4,162	1,34
Social status	3,133	1,47	3,333	1,87	4,000	1,42	3,679	1,63	3,162	1,75
Recognition and respect	3,985	1,37	4,417	1,31	4,509	1,27	3,643	1,36	4,081	1,71
Pro-social activity	3,005	1,56	3,667	1,56	3,368	1,38	3,500	1,47	3,919	1,40
Communication	3,323	1,44	3,083	2,1	3,157	1,37	3,536	1,53	3,568	1,67
Health	3,605	1,43	4,250	1,71	1,45	1,45	3,500	1,62	4,108	1,59

According to the data from the table, we can define dominant life values of each studied religious group. The value of charity is the leading for Jews and Muslims, as well as for Orthodox Christians. For Catholics, the leading values are pleasant pastime and recreation, which take the middle positions for the other cultures. Values of recognition and respect are particularly important for Muslims, while for the other cultures, it take the second - third places. For Buddhists, the value of enjoying beautiful play the leading role.

Table 2. *Cross-cultural peculiarities of life satisfaction and SWB.*

SWB & Life-satisfaction indicators	Orthodox Christians		Catholics		Muslims		Jews		Buddhists	
	M	St. D.	M	St. D.	M	St. D.	M	St. D.	M	St. D.
Life Satisfaction Index										
Zest	5,25	1,58	5,83	1,40	5,22	1,74	5,71	1,27	5,40	1,46
Resolution and fortitude	5,95	1,79	5,75	1,66	6,17	1,72	6,50	1,83	5,86	1,84

Congruence between desired and achieved goals	5,35	1,84	5,75	2,26	5,36	2,00	6,17	1,74	5,35	2,04
Positive self-concept	5,22	1,69	6,00	2,30	5,89	1,58	6,60	1,42	5,75	1,69
Mood tone	5,45	1,70	5,33	2,19	5,56	1,99	5,92	1,76	5,67	1,84
Overall level	27,20	5,68	28,4	5,85	28,29	6,44	30,92	5,12	27,97	5,45
Subjective Happiness	19,19	4,17	19,2	4,35	21,19	3,63	21,17	4,29	21,1	4,85
Psychological well-being										
Positive relations with other	59,50	12,83	63,50	13,25	62,28	14,23	64,60	15,30	68,59	12,79
Autonomy	61,23	13,58	56,0	14,00	62,71	13,30	67,14	16,73	67,43	16,77
Environmental mastery	59,80	13,53	58,16	13,98	62,82	15,03	67,32	17,98	68,51	16,19
Personal growth	64,00	12,12	60,66	13,29	66,00	11,89	66,53	15,97	67,83	13,73
Purpose in life	63,82	14,26	65,6	13,75	67,14	15,08	69,25	14,51	72,56	12,94
Self-	59,99	13,63	56,1	15,01	64,00	11,97	67,92	17,11	68,24	13,71
Affect balance	90,73	22,86	100,	28,68	86,80	23,34	85,60	22,40	89,97	19,95
Meaningfulness of life	92,00	17,71	81,16	21,53	93,77	22,86	94,35	19,14	96,59	20,37
Openness to the world	64,19	11,80	58,66	14,65	66,73	10,68	65,14	12,85	66,16	14,87
Overall level	539,2	124,7	545,	95,51	540,68	134,6	570,42	160,2	544,9	163,8

We can see from the table that people, belonging to Judaism, have slightly better results on all the scales of "Life Satisfaction Index" as well as on overall level of life satisfaction. Orthodox Christians showed the lowest result on overall level of life satisfaction and on scale of positive self-concept. Muslims responded the lowest level of zest for life, Catholics - the lowest level on the scale of resolution and fortitude, Buddhists showed lowest results on the scale of congruence between desired and achieved goals.

The data on the Subjective Happiness Scale show the higher level of it at Muslims and the lowest – at Orthodox Christians.

The data of Psychological Well-being Scale show that overall level of SWB again is the highest at Jews, and the lowest at Orthodox Christians. However, in separate scales we can see a bit different results: in most scales of the test, Buddhists responded the highest results, and Catholics – the lowest results. Only on the scale of the balance of affect, Catholics have best results, and Jews – the lowest one.

### 3.2. Cultural differences in life values and subjective well-being.

To assess statistical significance of identified cross-cultural differences between analyzed groups, pairwise comparisons were performed using Mann — Whitney U-test.

Significant differences of life values between Orthodox Christians and Catholics, and Orthodox and Jews were not revealed. In addition, differences between Catholics on one hand and Muslims and Jews on another hand were not found.

In comparison with Buddhists, for Orthodox values of enjoying beautiful ( $p=0,01$ ), new knowledge ( $p=0,01$ ) and pro-social activity ( $p=0,001$ ) are less important. For Muslims in comparison with Orthodox Christians the values of social status ( $p=0,0001$ ), recognition and respect ( $p=0,01$ ) are more important. Muslims also exceed Jews in importance of value recognition and respect ( $p=0,005$ ).

Differences in life values between Buddhists and Jews were not discovered. For Buddhists, in comparison with Catholics, the value of recreation is less important ( $0,04$ ); in comparison with Buddhists, the values of enjoying beautiful ( $p=0,005$ ) and new knowledge ( $p=0,02$ ) are more important; values of charity ( $p=0,04$ ) and social status ( $p=0,13$ ) are less important. Pairwise comparison of indicators of life satisfaction and subjective well-being gave us the next results.

Only one statistically significant difference were revealed between Orthodox Christians and Catholics - on the indicator of meaningfulness of life ( $p=0,04$ ). The indicator is higher at Orthodox.

Not much significant differences were found in SWB of Orthodox Christians and Muslims. Muslims reported higher results in subjective happiness level ( $p=0,001$ ), in positive self-concept ( $0,008$ ) and in self-acceptance ( $p=0,05$ ) than Orthodox.

Many significant differences in SWB were found between Orthodox Christians and Buddhists. Buddhists responded better results on subjective happiness ( $p=0,01$ ) and on many scales of SWB: positive relations with other ( $p=0,0001$ ), autonomy ( $0,01$ ), environmental mastery ( $p=0,0006$ ), purpose in life ( $p=0,0006$ ) and self-acceptance ( $p=0,0008$ ).

Similar results were obtained in comparison of Orthodox Christians and Jews. Overall life satisfaction of Jews is much higher, than of Orthodox Christians ( $p=0,001$ ), as well as congruence between desired and achieved goals ( $p=0,03$ ) and positive self-concept ( $p=0,00005$ ). Jews' data were also significantly higher than the data of Orthodox on scales of autonomy ( $p=0,04$ ), environmental mastery ( $p=0,009$ ) and self-acceptance ( $p=0,006$ ).

Catholics significantly exceed Buddhists in autonomy ( $p=0,04$ ), self-acceptance ( $p=0,01$ ) and meaningfulness of life ( $p=0,03$ ).

Only one significant difference exists in SWB of Catholics and Muslims – Catholics are more open to world than Muslims ( $p=0,03$ ). And one difference was found in SWB of Catholics and Jews – Catholics' self-acceptance was higher than Muslims ( $p=0,05$ ).

Buddhists responded higher scores on the scale of positive relations with other ( $p=0,03$ ) than Muslims; and lower overall level of life satisfaction ( $p=0,02$ ) and positive self-concept ( $p=0,02$ ) than Jews. Muslims also reported lower level of positive self-concept ( $p=0,05$ ) than Jews.

### 3.3. Correlations of subjective well-being and life values

Correlation analysis conducted on the total sample revealed multiple statistically significant correlations between indicators of SWB and life satisfaction with life values. Values of social status, pro-social activity, communication and health are more closely related to overall levels of SWB and life satisfaction and to separate scales of the test. The values of recognition and respect and material prosperity have less significant correlations with different scales. The value of enjoying beautiful significantly correlates only with life satisfaction and happiness, but not with SWB scales. The value of charity positively correlates only with overall level of life satisfaction and with the scales of resolution and fortitude and congruence between desired and achieved goals of the test of Life satisfaction. The value of new knowledge relates only to zest. The value of recreation doesn't have significant correlations with life satisfaction and SWB.

Correlation analysis conducted in each religious subgroup indicated different correlations of life values and life satisfaction and SWB. In particular, for Orthodox Christians, well-being and life satisfaction are related mostly to the value of pro-social activity, which is less important for this group, and they are also related to the values of communication, health and social status, which are on middle positions in this group. For Buddhists, life satisfaction is directly related to the values of material prosperity, social activity for positive change in society and social status, which are not so popular in this culture.

For Catholics, life satisfaction is related to the values of social status and charity. For Muslims it is associated with values of communication and respect, for the Jews – with the values of enjoying beautiful and new knowledge.

## 4. Discussion

Most received data on life values and SWB and life satisfaction are consistent with other empirical studies results and with basic principles of considered religions. According to our data, people belonging to the Jewish religion, are significantly

more satisfied with their lives than all the others. People brought up in the Orthodox Christian culture, are the least satisfied with their lives. In many subjective well-being indicators, representatives of the Buddhist and Muslim cultures show quite good results

Each cultural group has specific structure of subjective well-being indicators and specific correlations of subjective well-being with their life values. The results of the study may be used in developing culturally sensitive methods of psychological support and psychotherapy.

People of different cultures associate their well-being and lives satisfaction with different life values. However, in general, life satisfaction correlates with those values, which are less important for certain culture. Perhaps, persons, oriented on traditional and culturally important values are less happy than those, who are oriented for their individual ones. May be in assessing realization of individual values people use their own criteria, which are not as strict as criteria of common cultural values' realization. These results may also be due to the erosion of traditional cultures in most modern societies, the desire of individuals to the maximum realization of their individuality.

These ideas are supported by the data of many empirical studies, mentioned above, that proved closer connections of subjective well-being and life satisfaction with individual values than with collectivistic values.

## 5. Conclusions.

There are significant cross-cultural differences in life values and subjective well-being among residents of one country, belonging to different cultures. These differences have their sources in religious attitudes and settings. People of different cultures associate their well-being and life satisfaction with different values. Generally, well-being and life satisfaction are directly related to the values, less popular in certain culture.

## References

- Bobowik, M. , Basabe, N. , Pa´ez, D. , Jime´nez, A. , & Bilbao, A. (2011). Personal values and well-being among Europeans, Spanish natives and immigrants to Spain: Does the culture matter? *Journal of Happiness Studies*, 12 (3), 401–419.
- Bubnova, S. S. (1999). Principy i metody izucheniya tcnostnykh orientacij lichnosti kak sistemi s nelineinoy structuroi (The principles and methods for studying value orientations as a system with a nonlinear structure). *Psychological Review*, 20 (5), 38-44.
- Casas, F. , González, M. , Figuer, C. & Coenders, G. (2004). Subjective well-being, values and goal achievement: the case of planned versus by chance searches on the Internet. *Social indicators research*, 66, 123–141.
- Chebotareva, E. (2013). Regulatory aspects of subjective well-being. *Psychology and Health*, 28 Special issue: Supplement: 1, 185- 186.
- Chebotareva, E. (2014a). Psychological factors of ethnic extremism In Muslim youth. *Mediterranean Journal of Social Sciences*, 5 (22), 140-148.
- Chebotareva, E. (2014b). Role of Subjective Well-Being in Intercultural Adaptation. *Bulletin of the Peoples' Friendship University of Russia. Series: Psychology and Pedagogics*, 2, 13-17.
- Chebotareva, E. (2014c). The role of personal self-realization styles in cross-cultural communication. *Proceedings and abstracts of the 85th annual meeting of the Eastern psychological association*, Boston, MA. , 45.
- Chebotareva, E. (2014d). Multi-dimensional and functional approach to the intercultural adaptation study. *Journal of Educational and Social Research*, 4 (2), 170-174.
- Cohen, A. , & Shamai, O. (2010). The relationship between individual values, psychological well-being, and organizational commitment among Israeli police officers. *Policing: An International Journal of Police Strategies & Management*, 33 (1), 30-51.



- Diener, E. , Suh, E. M. , Lucas, R. E. , & Smith, H. L. (1999). Subjective well-being: Three decades of progress. *Psychological Bulletin*, 125, 276–302.
- Diener, E. , & Suh, E. M. (1999). National differences in subjective wellbeing. D. Kahneman, E. Diener, & N. Schwarz (Eds. ), *Well-being: The foundations of hedonic psychology*. New York: Russell Sage Foundation, 434–452.
- Diener, E. , & Diener, M. (1995). Cross-cultural correlates of life satisfaction and self-esteem. *Journal of Personality and Social Psychology*, 68, 653–663.
- Georgellis, Y. , Tsitsianis, N. , & Yin, Y. P. (2009). Personal values as mitigating factors in the link between income and life satisfaction: Evidence from the European Social Survey. *Social Indicators Research*, 91 (3), 329–344.
- Hofer, J. , Chasiotis, A. , & Campos, D. (2006). Congruence between social values and implicit motives: Effects on life satisfaction across three cultures. *European Journal of Personality*, 20, 305–324.
- Huta, V. , & Ryan, R. M. (2010). Pursuing pleasure or virtue: The differential and overlapping well-being benefits of hedonic and eudaimonic motives. *Journal of Happiness Studies*, 11 (6), 735–762.
- Joshanloo, M. , & Ghaedi, G. (2009). Value priorities as predictors of hedonic and eudaimonic aspects of well-being. *Personality and Individual Differences*, 47 (4), 294–298.
- Leontiev, D. A. (2000). *Test smyslozhisnennyh orientacij (SZHO) (Test of the Life Meanings Orientations)*, Moscow: Smysl.
- Lu, L. (2008). Culture, self, and subjective well-being: Cultural psychological and social change perspectives. *Psychologia*, 51, 290–303
- Lu, L. (2006). "Cultural fit": Individual and societal discrepancies in values, beliefs, and subjective well-being. *The Journal of Social Psychology*, 146 (2), 203–221.
- Lyubomirsky S. , Lepper H. S. (1999). A measure of subjective happiness: Preliminary reliability and construct validation. *Social Indicators Research*, 46 (2), 137-155.
- Neugarten, B. L. , Havighurst, R. J. , & Tobin, S. S. (1961). The measurement of life satisfaction. *Journal of Gerontology*, 16, 134-143.
- Oishi, S. , Diener, E. , Lucas, R. E. , & Suh, E. (1999). Cross-cultural variations in predictors of life satisfaction: Perspectives from needs and values. *Personality and Social Psychology Bulletin*, 25, 980–990.
- Pienaar, J. , Beukes, R. B. I. , & Esterhuysen, K. G. F. (2006). The relationship between conservatism and psychological well-being in adolescents. *South African Journal of Psychology*, 36 (2), 391–406.
- Ryff, C. (1989). Happiness is everything, or is it? Explorations on the meaning of psychological well-being. *Journal of Personality and Social Psychology*, 57, 1069–1081.
- Sagiv, L. , & Schwartz, S. H. (2000). Value priorities and subjective well-being: Direct relations and congruity effects. *European Journal of Social Psychology*, 30, 177–198.
- Schimmack, U. , Radhakrishnan, P. , Oishi, S. , Dzokoto, V. & Ahadi, V. (2002). Culture, Personality, and Subjective Well-Being: Integrating Process Models of Life Satisfaction. *Journal of Personality and Social Psychology*, 82 (4), 582–593.
- Schwartz, S. H. , & Bilsky, W. (1990). Toward a theory of the universal content and structure of human values: Extensions and cross cultural replications. *Journal of Personality and Social Psychology*, 58 (5), 878–891.
- Schwartz, S. H. , & Bardi, A. (2001). Value hierarchies across cultures: taking a similarities perspective. *Journal of Cross-Cultural Psychology*, 32 (3), 268–290.
- Schwartz, S. , Melech, G. , Lehmann, A. , Burgess, S. , Harris, M. , & Owens, V. (2001). Extending the cross-cultural validity of the theory of basic human values with a different method of measurement. *Journal of Cross-Cultural Psychology*, 32 (5), 519–542.

---

Suh, M. , Diener, E. , Oishi, S. , & Triandis, H. C. (1998). The shifting basis of life satisfaction judgments across cultures: Emotions versus norms. *Journal of Personality and Social Psychology*, 74, 482–493.

Triandis, H. C. (1995). *Individualism and collectivism*. Boulder, CO: Westview Press.

Vansteenkiste, M. , Neyrinck, B. , Niemiec, C. P. , Soenens, B. , De Witte, H. , & Van den Broeck, A. (2007). On the relations among work value orientations, psychological need satisfaction and job outcomes: A self-determination theory approach. *Journal of Occupational and Organizational Psychology*, 80 (2), 251–277.

Veenhoven, R. (1993). *Happiness in Nations, Subjective Appreciation of Life in 56 Nations 1946-1992*, Rotterdam: Erasmus University.

Yang, S. , & Stening, B. (2012). Cultural and ideological roots of materialism in China. *Social Indicators Research*, 108 (3), 441–452.

Yetim, U. (2003). The impacts of individualism/collectivism, self esteem, and feeling of mastery on life satisfaction among the Turkish university students and academicians. *Social Indicators Research*, 61 (3), 297–317.

Welzer, C. , & Inglehart, R. (2010). Agency, values and well-being: A human development model. *Social Indicators Research*, 97 (1), 43–63.

---

## Geographic Information Systems (GIS) in Urban Planning

**Ph.D. Sonila Xhafa**

State University of Tirana, Geography Department  
email: [sonilaxhafa@gmail.com](mailto:sonilaxhafa@gmail.com)

**Ph.D. Albana Kosovrasti**

State University of Tirana, Geography Department  
email: [sonilaxhafa@gmail.com](mailto:sonilaxhafa@gmail.com)

### Abstract

*Geographic information systems can be defined as a intelligent tool, to which it relates techniques for the implementation of processes such as the introduction, recording, storage, handling, processing and generation of spatial data. Use of GIS in urban planning helps and guides planners for an orderly development of settlements and infrastructure facilities within and outside urban areas. Continued growth of the population in urban centers generates the need for expansion of urban space, for its planning in terms of physical and social infrastructures in the service of the community, based on the principles of sustainable development. In addition urbanization is accompanied with numerous structural transformations and functional cities, which should be evaluated in spatial context, to be managed and planned according to the principles of sustainable development. Urban planning connects directly with land use and design of the urban environment, including physical and social infrastructure in service of the urban community, constituting a challenge to global levels. Use of GIS in this field is a different approach regarding the space, its development and design, analysis and modeling of various processes occurring in it, as well as interconnections between these processes or developments in space.*

**Keywords:** GIS, urban planning, territory management, sustainable development etc.

### 1. Introduction

People have used maps for centuries to reflect the terrestrial environment and the processes that occur in it, to show the locations and measure distances, for navigation, for exploration and illustration of the phenomena, for communication in public and private sector.

But which is more important is its role in reflecting the relations between objects in the real world and between them and space, as well as their planning and developmental models in territory.

GIS are part of spatial information systems. They process, and generate spatial information (through cartographic and photogrametric products, statistical reports etc.).

GIS products mainly with spatial containing, are result of the integration of spatial information and other data with multithematic character. In GIS real world models generally come in mapping and imaging formats .

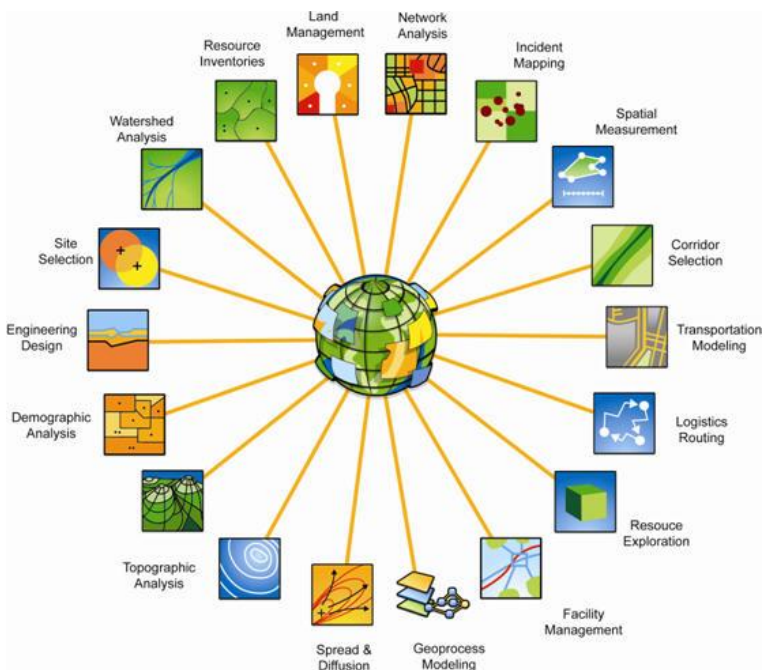
Almost in any field of study and of human activity, maps, aerial photos, satellite images

are necessary products and analytical instruments for many aspects of academic and professional life. Nowadays GIS are expanding quite their range of functions and applications. More than 60 disciplines and departments in colleges and universities in the world have integrated GIS within their curricula and research, as the science of geography, geology, archeology, agriculture, journalism, biology, economics, engineering, political science, computer science, urban planning, environment etc.

Uses of GIS continue to grow beyond businesses, industries, universities and government sector. In

current economic conditions and urban developments such as in regional levels , as well as in global level, the demand for the use of the natural resources (soil, water , vegetation .) is growing, which dictates even in many cases their irrational use through several informal actions. In these conditions, is necessary their good management. Human community has recognized the need for better sharing of resources between them for all life forms and activities. GIS plays an essential

role in providing optimum models of land use and its resources. It is important to know where these resources are located (spatial data), their relations with objects, events and other phenomenas, the conditions in which they develop, ways how you can continually monitor them, as to register and arrange in such a way as to recover them at any moment where we need their use etc. Use of GIS in urban planning helps and guides planners for an orderly development of settlements and infrastructure facilities within and outside urban areas.



Source: [http://www.directionsmag.com/images/newsletter/2011/01\\_week1/world\\_lq.jpg](http://www.directionsmag.com/images/newsletter/2011/01_week1/world_lq.jpg)

In this context , its use in urban planning is indispensable given that in the world live 7.25 billion people, where 53.7 % of them live in urban centers <sup>1</sup>. This growth dictates the need for urban spatial planning based on the principles of sustainable development . Nowadays territorial development, are affected from population growth beyond the carrying capacity of the territory, from global warming , social conflicts, human development , economic development activities at the expense of natural spaces , loss of biodiversity and environmental pollution problems. Such situations are common in daily activity together with their complexity and their severity constituting the emergency challenges in the future in terms of their solution.

In this context , is necessary the possession of full knowledge of the territory , mainly in terms of its planning and its development in the future based on the principles of sustainable development. GIS provide an enabling environment in which the spatial and attributive data are recorded and stored, which are used in every field of study.

Today urban life is facing multiple challenges , such as pollution and traffic , poor access to public services etc. , challenges which are addressed to the planning process, which is more fast, efficient and with more quality using GIS technology .

Use of GIS in this area is an approach and a different opinion regarding the space , its development and its design , analysis and modeling of various processes occurring in it, as well as interconnections between these processes or developments with space. Solutions that provides GIS in urban planning can affect the growth of the design and planning of the territory having the spotlight on the community , the further development of economic poles , improving the quality of life in general , the growth of social service planning , etc .

<sup>1</sup> *Current world population*. United Nations, Department of Economic and Social Affairs. 2014

## 2. Brief historical overview of the use of GIS in urban planning

The level of development of all information systems has been high, and therefore in this context is not the exception GIS. GIS as a multifunctional set and consequently with an intensive use in different areas, after 1990, GIS progressed with specific applications in different fields, initially as archive systems, analysis systems, presentation systems, and finally as the decision-making systems.

The genesis of the use of GIS in urban planning, is related to chaotic transformations that suffered the urban city and industrial centers in the mid nineteenth century. At the end of this century, the necessity of implementation of GIS in urban planning came as a necessity of achieving territorial decisions by evaluating a number of factors and conditions at the same time to arrive at an optimal result that reflects adequate planning goals.

In this period, urban planners widely used archive and analysis context of GIS. Decision-making in this period rely on statistical analysis, but also spatial analysis relying on existing maps.

Manual processing of data in this period limited the spatial analysis. In the early 1970 appeared the first models of the digital data mapping. Computer systems provide tools and techniques for automated processing of data with significant volume. In this period were built the first foundations of today's concepts and applications of GIS in urban planning. The transition from analog formats of graphic data in digital ones, through geometric representations (point - for settlements, polyline-for roads and polygon - for surfaces), in one coordinate system gave a new incentive this process in general, and helped the process of re-design of the rapid changes in the territory. Within a short time, many developing countries enabled the updating of existing urban maps.

A big role to the urban planification throughout GIS, played the functioning for the first time in USA of the Landsat satellite. It was used to capture and record in time spatial data at global level. This event encouraged the orientation of searchings for improvements in data structuring and analyzing.

After 1980, SMD<sup>1</sup> were developed from which was attained the codification and identification of geographical features in territory, as well as main infrastructural urban objects, which provided the fastest extraction of results regarding these features or a given object. Nowadays, research in urban planification were orientated in issues linked to accuracy, structuring, availability of data, as well as their integration in other fields.

Since the early 1980s, there was a significant increase in the installation of GIS in different levels of urban planning in developing countries, especially in Europe and North America, and later in countries in development after 1990.

During the 1990s, attention was directed to the depth spatial analysis for urban planning, where GIS was structured with analytical systems for mathematical and statistical solutions.

Integration of GPS and Remote Sensing in GIS, the massive use of aerial photos and satellite imagery as data sources, improved the analysis in urban planning, as well as increased the efficiency in decision making.

Today GIS is increasingly accessible, constituting an important tool for urban planning in terms of integration of data from different sources to provide information necessary for effective decision-making. GIS technology correlates a wide range of variables to arrive at more effective decision making in the territory.

## 3. The use of GIS in urban planning

GIS products have content space (mainly geographical). At the foundation of the functions of GIS stand spatial analysis. GIS are mainly used in land use planning, service management, ecosystem modeling, assessment and planning of landscape, transport and infrastructure planning, market analysis, evaluation of real estate etc.

Urban planners use GIS technology in monitoring, development and implementation of their projects in service to facilitate the decision-making process. In this context the role of GIS in urban planning takes place through the growth and

---

<sup>1</sup> database management system

development of archive, management, analytical and modeling instruments. All these functions have placed GIS as one of the implementing and comprehensive techniques in many areas.

### 3.1. GIS as an archive and inventory system

In all contents of GIS terminology, what is important is the term geo - information. In fact the term geo - information is used simultaneously with the use of automated procedures for the development of information systems for data with spatial context. In this context becomes more important the necessity not only for geo-information production, but also for archiving of the data. From here ran the database concept. Based on functions of Database System, a GIS operates and analyzes the data, but initially registers and archives them.

During urban planning and territorial designs, GIS provides archiving of voluminous and multi - thematic data closely associated with the geographical reference in the service of specific applications.

Database System in GIS, initially has archive functions that should be constantly maintained, so that data could be safe and durable so they could be used at any period of need. A major influence in building of the database in urban planning, have the maps of real estate assessment which provides a variety of data and a comprehensive database on the location of the property, their ownership, prices, proximity of the property with social facilities, material of construction, number of floors, covering with infrastructure, risk factors etc.

The system of storage and retrieval of data in GIS organizes data as spatial and attributive data, so the updateing, analysing and decision-making can be carried out as soon as possible.

GIS inventory and classify data based on a predetermined criterion. Planners can also extract data from the database derived from modeling and spatial analysis. Some GIS use database management system to maintain their attributes associated with the corresponding topology and spatial context.

GIS organizes thematic spatial data through various Database formats, like Excel, Access, SQL, ORACLE etc., which labeled in GIS as Geo - database which are important in urban planning.

In database management system there are three types of data: the location of objects (defined through reference coordinate system), the attributes associated with them (attributes of objects) and relationships that arise through spatial reference and features of one or several objects with other objects.

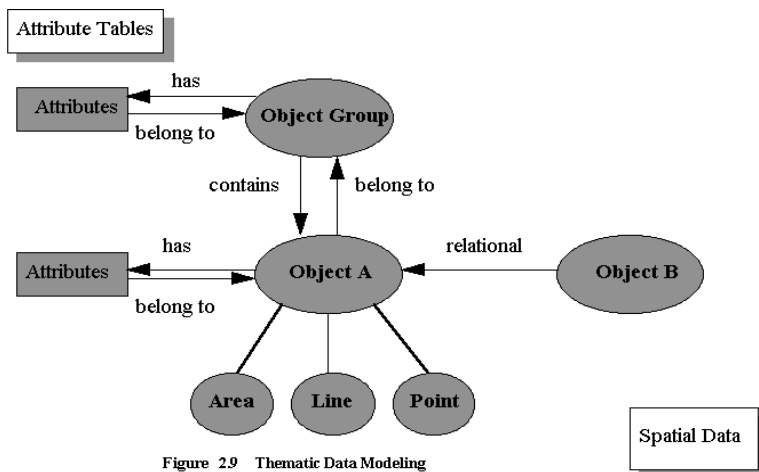


Figure 29 Thematic Data Modeling

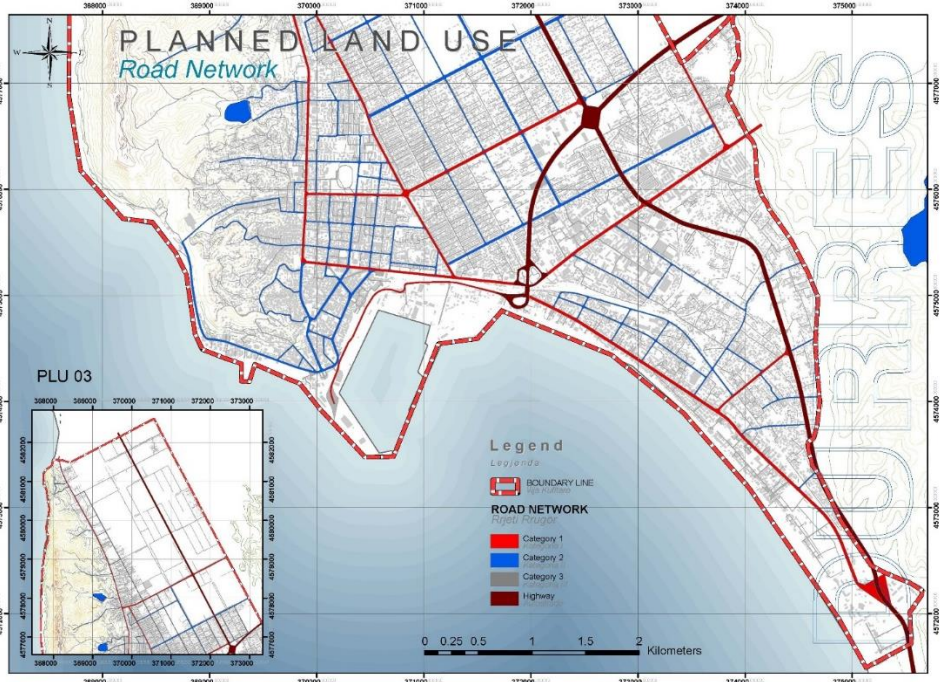
Fig.3. Organization and modeling of data in GIS. Burimi: <http://cret.cnu.edu.cn>

This type of organization of data is important in urban planning since the residences are associated with social infrastructures the road with the city, a city with another city etc.

### 3.2. GIS as a monitoring and management system

SIG throughout cartographic products and spatial analyses enables:

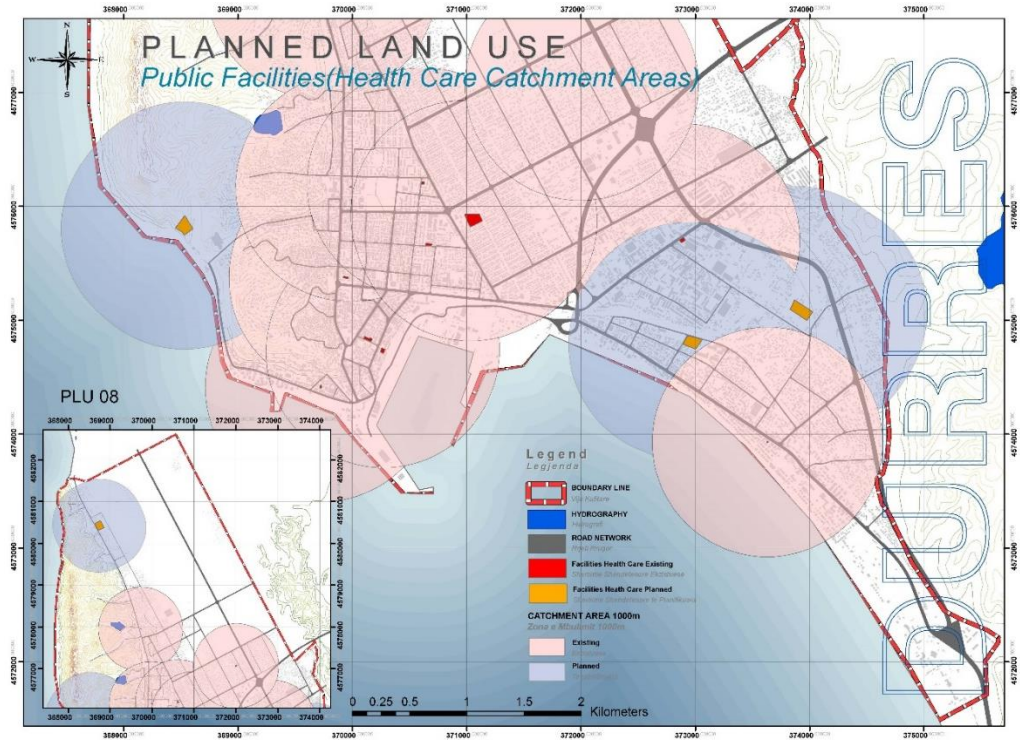
- monitoring, management and periodic maintenance of social and physical infrastructure in urban centers and beyond; (map 1)
- implementation of integrated analyzes for full coverage of the community with public infrastructure, compilation of alternatives for a sustainable distribution of social and economic facilities in order to increase the accessibility of community in these services;
- preparation prognosis plans of management of infrastructure according the needs of the community based on the future trends of demographic growth and integrated analysis territory / population / infrastructure;
- decision-making, management and solution in time of conflict situations in the territory in case of misuse;
- monitoring, diagnosis of the territory , especially in spaces with the lack of public infrastructure , in spaces inclined for potential territorial developments, in exclusion space development, in urban spaces planned for reclamation and environmental regeneration etc.



Map 2: Road infrastructure. Urban Planning Office. Municipality of Durrës

### 3.3. GIS as an analytical system

GIS use archive database for compilation of queries (question and answer) that serves for spatial analysis such as: What are the least populated areas within 70 km radius distance from the town , or what are the areas with the highest consumption in the seaside resort; which are health centers located 500 m from the residential center. (map 2)



Map 2: Current and planned health infrastructure in the town of Durres (Buffer-Arc GIS 9.0 methodology) . Cooperative product with Urban Planning Office (Municipality of Durres) in the function of Lamp Project on the long-term planning in urban spaces and territory regulation, January, 2007

The goal of GIS is that any specific data out of general database could serve for one primary purpose, to develop a unique geographical analysis. GIS is a powerful tool for the implementation of integrated analysis and trend analysis.

GIS is given emphasis in his analytical skills , or in its application to solve specific issues in various fields , but also in scientific research applications. Such applications come to the users from the simples formats to integrated formats for achievement of specific purposes In this context, Geographic Information Systems are characterized by :

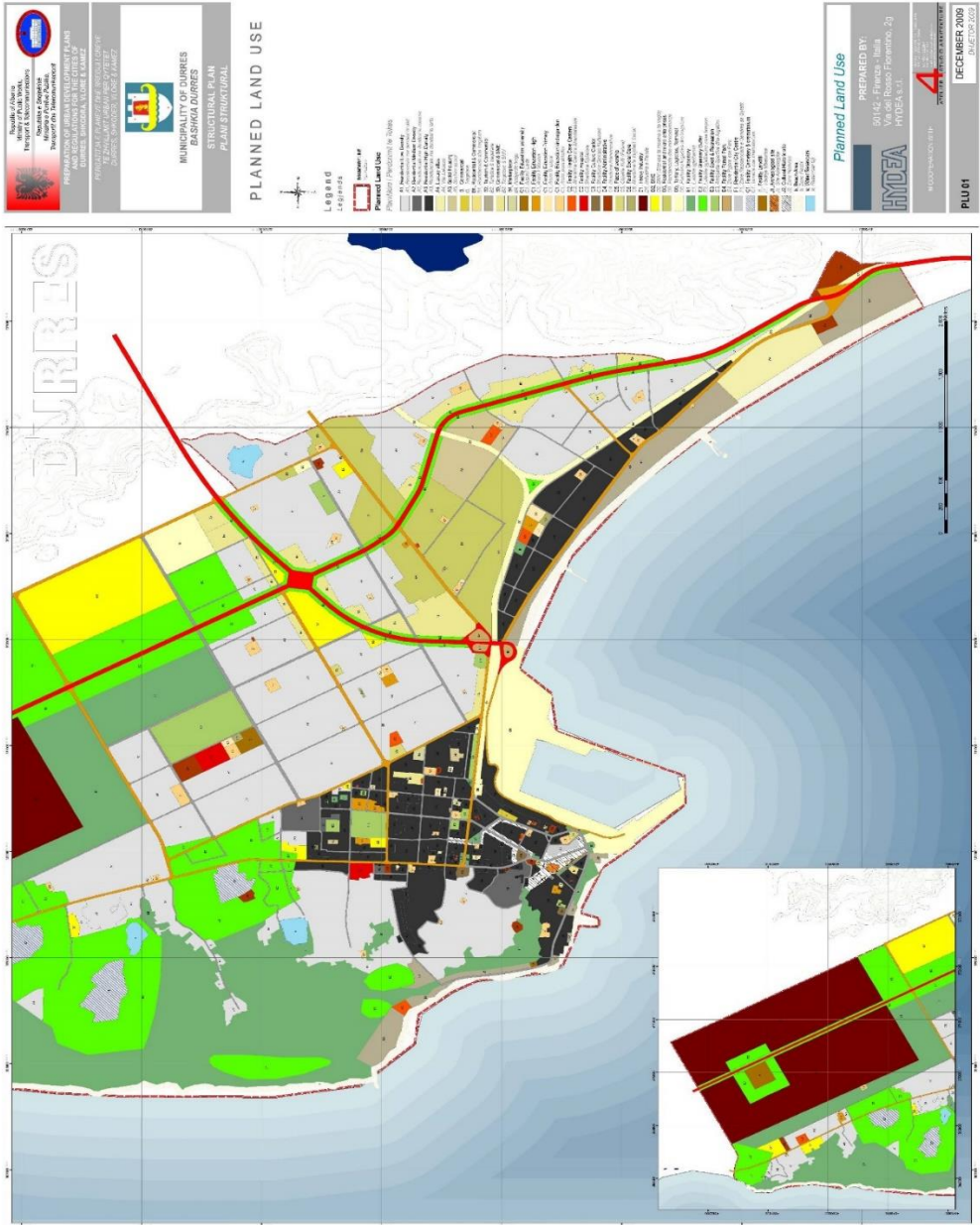
- ability of using voluminous data, and with specific purpose in service to analysis process. In this case, often the data collected are stored and archived for a specific purpose, and used for analysis within a project with specific content.
- great analytical bilities , mainly in statistical and modeling applications.

The purpose of the analytical system in GIS is building a clear understanding on relations between spatial position and geographical phenomenon. Its functionality related to urban modeling enables:

- zoning of urban space, based on the function and territorial linkages , infrastructure linkages, environmental linkages, etc.



- classification of urban space, based on the type of strategies to be followed today and in the future (emergency intervention strategies, assessment strategies , protection and regeneration strategies, etc).
- building a functional structural scenario, determining the exact size of the buildings and facilities services in the future, as well as defining the environmental and infrastructure connecting structures, etc.



Map 3: Land use in the town of Durres. Municipality of Durres

### 3.4. GIS as a decision-making system

GIS enables us to see, to understand, to interpret and visualize data in different forms, where we can find various spatial correlations, patterns, and trends in the form of maps, statistical reports and charts, etc. In this context it is an important decision-making tool in various fields. GIS is able to design possible alternatives and future development of the territory, of population, of economy development etc. Applications of GIS in support decision making allow:

- designing different alternatives of actions in the territory, through the examination of the data with different thematic content, which are integrated with each other and are related to the spatial context.
- linking data with different thematic patterns in territory development models
- designing projections of triad population/area/economy in the future
- designing of building models of the urban territory, land-use models, evaluation and expertise models of the territory, offering quality, efficient, fast and accurate products that facilitate the decision making process

**In conclusion**, the use of GIS in urban planning has led to:

- use of qualitative analytical products, and consequently effective decision making;
- higher efficiency in the extraction of spatial information, and therefore qualitative analysis;
- use of a wide range of multi - thematic data in the service of decision making in urban planning;
- improve the quality of spatial analysis process and of public service in urban planning institutions;
- Increasing consciousness on the territory and spatial thinking in community

#### Bibliography:

1. Batty M 1990 *Information systems and technology for urban and regional planning in developing countries: a review of UNCRD's research project, Vol. 1*. Nagoya, Japan, United Nations Centre for Regional Development
2. BURROUGH, P.A. and MCDONNELL (1998) *Principles of Geographical Information Systems, Spatial Information Systems Series*. New York/Oxford: Oxford University Press.
3. ESRI, *GIS for Urban and Regional Planning*, January 2011
4. GJATA G., *Imazhet satelitore. Teledeteksioni*, Tirane 2007
5. NIKOLLI P., *Vështrim mbi të dhënat dhe informacionin gjeografik*, Studime Gjeografike 13, Tiranë 2002.
6. XHAFI S. and HASANI B., *Urban planning challenges in the peripheral areas of Durrës city (Porto Romano)*, Mediterranean Journal of Social Sciences, Vol.4 (2103) No.10: 605-614

## Exercise Habits of Women 40 Ages and Over

Assoc. Prof. Dr. Fatma Çelik Kayapınar

Ece Ergen

Mehmet Akif Ersoy University, Physical Education, Burdur

### Abstract

*The purpose of the research was to determine of habits about exercise of women of 40 ages and over. Research; December 2013 was made in Antalya province in Turkey. The research sample was consisted of 500 women. The data was taken into consideration; age, height, weight, marital status, number of children, education level, income level, active working life, health problems, treated diseases, hereditary diseases, operational status, prosthetic status in the body, psychological treatment or support, regular exercise habits and physical education lesson consisted questions. In the pre-implementation; The purpose of the research was explained and took verbal consent of the volunteer women. Frequency and percentages used for evaluation of the data. In conclusion; women were not have exercise habits and its reason that they were housewife.*

**Keywords:** 40 ages and over, women, exercise, habit

### Introduction

The development of technology has led so many daily physical task to do with a good deal of tools. And this resulted in to gain time for spare time spare time activities. Nevertheless so many people prefer to live immobile. Although human body designed to move and make challenging physical activities; yet the exercise is not among the daily efforts of average life style. (1)

It is stated that when human body lives without movements that its needs for a long time it will lose some of its functional capabilities; and these functional capabilities will cause so many diseases.

The diseases are defined as hypokinetic diseases in the end of sedentary life. (1)

The people who do not make regular exercise have very high risk to contract diseases such as coronary heart disease, high blood pressure, high cholesterol, cancer, musculoskeletal disorders and obesity. (1,2)

According to the health risks the most effective types of exercise are such increasing aerobic capacity as walking, jogging, hiking, biking, boating, and swimming. With aerobic exercises high efficiency could obtain to eliminate such diseases which are particularly obesity, cardiovascular disease and deformation of the bones. (3)

Many studies shows that active individuals have lower risk to have heart disease than sedentary people. Recent studies emphasizes that the regular exercises and level of cardiorespiratory fitness are very important to prevention of heart diseases. (4-5)

In the period of middle ages and above physical suitability levels are decreases and thus increases the risk of diseases. The serious diseases which are more frequently observed in this period as heart disease , osteoporosis, obesity, hypertension, cancer and diabetes threatens society as effects adversely individuals.

Obesity is a major risk factor for coronary heart disease. Obesity is characterized by the height of the excess fat and endomorphy rate and inactive, sedentary lifestyle is one of the causes of obesity (6,7).

This study 40 years and older was conducted to investigate the level of knowledge about exercise in women.

### Materials and Methods:

The research sample was consisted of 500 women. Research method is screening model. Percent and frequency are used to evaluating the data. The data taken into consideration; age, height, weight, marital status, number of children, education level, income level, working life, health problems, treatment finished diseases, hereditary diseases, an operation status, prosthetic status in the body, psychological treatment support, regular exercise habits and physical education consists of questions about the course. December 2013 on the application was made in Antalya province.

Survey prior to application; aim is then discussed and made verbal consent of the volunteer women.

### Results and Interpretation:

**Table 1: Percent and Frequency Results.**

Variable	Answer	%	n	Total
Marital Status	Married	%76,4	382	500
Do You Work?	No	%66,6	333	500
Did You Have Working Life?	Never Worked	%61,4	307	500
Do You Have Health Problems?	Yes	%50,6	253	500
Do You Have Finished Your Treatment Discomfort?	NO	%79,6	398	500
Do You Have Any Hereditary Disease?	No	%79,4	397	500
Have You Had Surgery?	Yes	%58,4	292	500
Is There A Prosthesis?	No	%80,2	401	500
Do You Have Any Psychological Treatment?	No	%80,4	402	500
Do You Take Regular Exercise?	No	%57,0	285	500
Is Your Exercise Affects Your State Income?	No	%74,4	372	500
What Are The Factors That Affect Your Exercising?	I'm Not Interested	% 6,3	23	500
	Losing Weight	% 4,9	18	
Do You Think That Regular Exercise Has An Effect On Health?	Yes	%95,6	478	500
How Many Years Have You Taken Physical Education Classes?	11 Year	% 25	125	500
Have You Exercise A Directed In Physical Education Classes?	No	% 49,8	249	500

Research group; 48.8 years of age, height 156.8 cm, 69.1 kg of body weight ratio was composed of 500 women with an average volunteer.

According to the lady of the data obtained; response options being married the marital status was determined that 30.8% of high school education 76.4% status.

How much is the monthly income? The question; the answer is not the income you 48.2% Work? "No answer to the question 66.6% of the active working life by how many years? 'question was found to give 61.4 reputation no response.

Do you have health problems? Received 50.6% answered yes to the question; What was that about health problems from blood pressure responses received, 10%, 4.5% glucose, thyroid, 3.5%, 3.5% asthma, rheumatism, 2.5%, 2.5% hernia, heart rate is 1.5% respectively.

Do you have finished your treatment discomfort? 79.6% of the question, no, 14.6% yes; If that is what the finished treatment of gynecological diseases and disorders response rate reached 17.5%.

Do you have any hereditary disease? Questions to 79.4% no, 20.6% yes; 28.6% of what disturbed that hereditary blood pressure, 14.3% sugar, reached the value of 8.8% of heart failure.

Have you had surgery? 58.4% to the question, yes, 40.8% no; What are the answers that passed cesarean surgery 25.7%, 12.3%, gynecological diseases, appendicitis, 5.7%, 5.4%, gallbladder, breast 4.2%, 2.3% nose, goiter and 1.9% thyroid, and kidney hemorrhoid 1.5% 1.1% meniscus has been found that eyes and hernia surgery.

Is there a prosthesis? Questions to no 80.2% yes 19.8%; where the response has been reached that the prosthesis in the mouth with 80.8%.

Do you have any psychological treatment? Questions 80.4% no, 17.2% yes; Did you using psychological medicine or did you use? 55.1% 25.5% yes to the question, no answer was given over 19.4% yes, I'm still using.

Do you take regular exercise? Questions to 57.0% of the women with 41.8% yes no life without active exercise greatly; How many days per week do you do sports? 3 day 36.2% of the question, how many hours do you do? Questions to 67.5% for 1 hour, did you or do you do if exercise alone group 'to have reached 55.4% only answer. Does the doctor have been recommended by doctors and 51.3% of the questions that have no incentive to exercise and exercise affect your case for you to exercise your income? If the question has been no 74,4%.

What are the factors that affect your exercising? Questions do not have time to 17.3%, 17.3% gave the answer to be healthy. 15.6% cannot because of my illness, feels lazy 12.9%, 6.3% I'm not interested, I'm due to weakening of 4.9%, 4.4% has been reached, and I do to lose weight to be more healthy response.

Do you think that regular exercise has an effect on health? 95.6% yes to the question; explanation of 17.8% as the response is beneficial to health, health and quality of life was found to give the answer to 12.6%.

How many years have you taken physical education classes? 25% Question 11 years, 5 years, 21.8%, 9.2% for 8 years, 12 years, 8.0%, 4.4% for 6 years and 4.0% 3 years is found to be 2.2% for 15 years. Directed to exercise in physical education classes? Questions to 49.8% no, 41.4% yes, the physical education teacher or your teacher gave information about the benefits of exercise? If yes to Question 51.0% response rate was achieved in 38.0% no.

## Recommendations

1. Women can exercise by municipalities for days that can be applied in every neighborhood.
2. Training on behalf of the lack of awareness by the experts to do the exercises, you can increase awareness by giving lectures and sayings.
3. Exercise to lose weight by making a measurement of days per month and ensuring that the tightening observed in the concrete can be increased participation in exercise.
4. Athletes during certain times of the day may be asked to exercise participation and bringing women athletes / athletes achieved to see visually.

5. By the State; units can be installed about to have a healthy weight.
6. Weight control, and institutions such as health centers can be done with patient follow-up.
7. Ministry of Education of physical education lessons and work done to create the habit of exercising their applications.
8. Exercise incentive for future weight gain experienced by the Ministry of Youth and Sports, on behalf of failure rate, projects to acquire the habit of doing exercise can be carried out.

**Sources:**

1. Özer, K. (2001). Physical Fitness, 1st edition, Nobel Publications, Ankara
2. Peker, İ., Çiloğlu, F., Buruk, Ş. (2000). Effects of Exercise and Exercise + Diet Blood Lipids, Sports Research Journal (2): 33-46.
3. Zorba, E. (1999). 1. Everyone's Sports and Physical Fitness, Meyir Printing, Ankara.
4. Howley ET, Franks BD. Health Fitness, Second Edition, Human Kinetics Publishers Ltd, Champaign, Illinois 1992
5. Solak H, Görmüş IS, Solak T, Görmüş N. Sports and our heart, Nobel Publications, Ankara 2002.
6. Carter JEL, Heath BH. Somatotyping-Development and Application, University Pres, Cambridge 1990.
7. Chisholm DJ, Samaras K, Markovic T, Carey D, Lapsys N, Campbell LV. Obesity: Genes, Glands or Gluttony?, Reprod Fertil Dev, 1998, 10(1): 49-538.

---

## Creative Thinking -Perception of Teachers in Relation to its Importance

**Dr. Shqipe Haxhiyseni**

“Aleksander Moisiu” University

Durres, Albania

shqipeshyti@yahoo.com

### Abstract

*Creative thinking is an important element in the process of education and social development, but little treat in teaching practice. The purpose of this paper is to highlight the factors that encourage creativity of the child and the factors that constrain it, mainly in the educational environment, thinking that the way the teacher perceives creative mind plays an important factor in the development or diminishing its . Drawing on contemporary literature review on the topic provided the theoretical foundations that support the development of creative thinking and through surveys of teachers will emerge problems with the perception of teachers about creative thinking and its importance in the development of students. Results of the study show that the perception of teachers for the form of thinking that should encourage the students is an important factor to help students increase their chances to get in the right way at teaching knowledge and use it productively creative in their future.*

**Keywords:** creative thinking, perception of teachers, incentive thinking

### Introduction

My 20 years experience of teaching has led me study creative thinking and the way it is perceived, because along this period my observation is that there is little attention paid to it; and teachers work are focused on knowledge acquisition and have neglected creative thinking. Similar, in the Albanian literature (pedagogical) it is spoken less about creative thinking whereas the time we live in requires creative thinking, just as stated in the curricular framework presented by IZHA (Education Development Institute). Acquisition and elaboration of knowledge autonomously, creatively, responsibility are of high importance in order to learn, as well to decision making and problem solving. Keeping in mind the complexity of society and of today economy based on knowledge, information management is a key competence in the XXI<sup>st</sup> century. Students need not only to acquire that information but to develop the necessary skills to thinking critically, creatively and interactively.

### Literature Review

Michael Mumford suggested: "Over the course of the last decade, however, we seem to have reached a general agreement that creativity involves the production of novel, useful products" (Mumford, 2003, p. 110). Creativity can also be defined "as the process of producing something that is both original and worthwhile" or "characterized by originality and expressiveness and imagination". What generates might come in different forms for various subjects or areas.

### Importance of creative thinking

Critical and creative thinking are the keys to work and economic prosperity in the twenty-first century. There is a long-term trend away from routine-oriented work, which requires people to do the same things every day, and toward creativity-oriented jobs that ask people to engage in analysis and to make judgments. The creative class includes people whose work is to create new forms (for example, writers, engineers, and designers) and people who work in a wide range of knowledge-intensive industries that ask them to make critical and creative decisions about specific problems in their fields. According to Patel in web page: Think "Successful universities in the twenty-first century will be those that educate graduates who contribute to a critical and creative workforce". Therefore the curriculum of a specific school whether elementary,

---

secondary, or college, should have it as a must to include creative and critical thinking along classroom activities and have them interrelated in between. Thus decision making and problem solving are 2 most important of the many areas that teachers may help foster students creativity because in general students are more motivated when they have to do a task where they should put their own efforts which don't go in vain but that seems really valuable to their practical life.

There are many methods on how to increase creativity. Psychologists, Synetics, Mathematicians and many other researchers have developed ideas and programs and variants on how to foster and increase creative thinking.

Much of the thinking done in formal education stresses out the skills of teaching students understand claims, the answer, create a logical argument, eliminate the incorrect paths and focus on the correct one. However, there is another kind of thinking, one that focuses on exploring ideas, generating possibilities, looking for many right answers rather than just one. Both of these kinds of thinking are vital to a successful working life, yet the latter one tends to be ignored until after college.

Creativity: It's been maligned, neglected, and misunderstood. But it's finally coming into its own (Azzam, 2009). Creativity is being introduced as the crucial skill of our century in order to problem solving. However, creativity is more than just ideas on the spot, instead it is a kind of assessment, because every thing that you are facing with needs to be assessed first then solved. So, creativity process is deeper than just thinking about the issue.

But why it is given so much emphasis to creative thinking just right now?

The answer is that the world has transformed so much that people need to think really quickly about their lives and about everything they do. People face a lot of different, strange, quite ridiculous challenges that they must have a creative mind to deal with all this otherwise the failure is behind the window. Information comes to us in an advanced way and everyday there are huge changes which are not visible to the eye but they impact greatly on each individual's life. Eras of the history have not been the same not one equal to another, therefore every period has developed something important at the time needed. This is also the case of creative thinking. It is needed now and for the future of our children. They must be informed about all these changes and must learn and confront them in a creative way, with their imagination. And this happens only if teachers do foster a creative thinking and help their little minds and behaviors imagine and create in order to solve and make decisions for their future and for their present life and world.

Can creativity be taught?

The creativity expert Sir Ken Robinson believes that it is possible to teach creativity, although some people say they can't. This comes from the fact that they do not understand it themselves and it is very difficult to teach something you don't understand first.

"But there are actually two ways of thinking about teaching creativity. First of all, we can teach generic skills of creative thinking, just in the way we can teach people to read, write, and do math. Some basic skills can free up the way people approach problems—skills of divergent thinking, for example, which encourage creativity through the use of analogies, metaphors, and visual thinking." (cited above)

### **Developing creativity**

*'We really need to stop considering thinking as simply 'intelligence in action' and think of it as a skill that can be developed by everyone.'* (Edward De Bono, 1982)

According to De Bono (1982) fostering creativity in an effective way we must develop some techniques that are specific for thinking because our brain is not designed for that purpose as the first purpose of its function and it is not capable of creating great things or ideas.

Over the years, De Bono and other writers have promoted the view that creative thinking is something that can be developed by anyone and they have formulated a wide range of practical techniques to develop thinking skills.



## Methodology

### Participants and Setting

This study aims to determine whether the perception of teachers on creativity matches classroom practices they apply. The sample included 32 teachers of five elementary schools of the city of Elbasan, which were chosen based on their availability and convenience to submit first round of surveys, respectively. Teachers participating in the questionnaire had different levels of grade, including teachers of the program English as a Second Language (ESL) and teachers of special education

### Variables

The survey contained questions about classroom daily practices and classroom procedures, methods of grading and expectations of teacher. The first two involved classroom material location, choices of students and methods of instruction. Method of grading and expectation of teacher concentrated on what the teacher looks for in the works of students and their classroom participation. The survey was created by researcher, based on literature and adjusted for the purpose of this study. Its validity and reliability is not known.

### Procedures of Data Collection

Prior to the beginning of the project it was obtained a written permission from the public school system coordinator. Survey participants were volunteers who had consented since the first round surveys and were informed on confidentiality of their responses linked to personal identification.

The second and third round of surveys were sent to teachers electronically, by email, thus they managed completion time on their own. Their individual responses were then collected into aggregated data.

### Instrument

The study instrument of research integrated three consecutive completed surveys by the participants. Surveys were created based on literature research that linked with creative thinking activities, its qualities and its fostering. The first two surveys contained ideas or activities regarding grading methods, practices and procedures of classroom and expectations of teachers. Survey questions were rated on a Likert-scale 0-10, where participants had to choose their agreement degree in each given statement by selecting numbers from 0 which showed *Never* to 10 which showed *Always*. The first survey measured the frequency of occurred classroom activities and it showed approximately equal numbers of activities that impeded and fostered creativity ideas or thoughts. The second survey measured the specific activities that teachers considered as appropriate to help creativity. The third survey measured what was each teacher's belief about creative thinking in general with the children being present in the classroom environment. This survey was designed to have Likert-scale questions and short answer spaces combination in case of any additional comments.

### Procedure

The first survey drew activities which promoted and hindered creative thinking in the classroom. These activities were rated by the teacher according to their frequency in the classroom on a 1-10 scale.

The last two surveys were sent electronically to the provided email addresses at the same time. Also, reminders were sent each day after the first delivery. The second survey contained the same activities as the first survey but here teachers were asked to rate activities based on their personal belief on each activity potential to help and foster creative thinking. Afterwards, the two surveys were compared in order to analyze the relationship of beliefs of teachers on these activities and the time they spent in the classroom to foster them in students mind and behavior.

The third survey contained questions asking teachers to give opinions and again beliefs to be used for the fostering of classroom creativity. This last survey drew some feedback on participants perception based on practices in the classroom.

## Results

### Demographics

All respondents were female teachers. **Table 1.** The percentage of respondents from each participating grade level and from each participating school.

School	Percentage	Grade	percentage
School 1	18.75	ESL Teacher	12.50
School 2	12.50	Special education	18.75
School 3	18.75	Grade 1-2	25.00
School 4	25.00	Grade 3-4	25.00
School 5	25.00	Grade 5	18.75

### Participation

The first survey delivered to the 32 respondents was paper based which regarded the frequency of different classroom activities. Between the first survey and the second survey there was a 52% completion decrease of surveys, meaning 18 total of completed responses. Between the second survey and the third survey there was even more decrease in completion by 75 %, thus 14 total of completed responses.

### Data Analysis

For the purpose of data analysis, questions of the first and second surveys were divided into categories, where the first category included activities of teaching that foster creativity and the second category the activities of teaching that do not foster it.

For data analysis purposes, the questions presented in Surveys 1 and 2 were divided into the following two dichotomous categories: (a) teaching activities that foster creativity and (b) teaching activities that do not foster creativity. Responses were divided into 5 categories from 0-1 strongly disagree, 2-3 disagree, 4-6 neutral, 7-8 agree, 9-10 strongly agree. Activities of the classroom that foster creativity make 15% (x questions) of all classroom activities.

Activities that do not foster creativity make 40% of occurred activities often within the respondents' classrooms.

10 of the questions are believed to be on activities of the classroom fostering creative thinking. 4 questions were in fact that didn't have high scores included process of instruction and classroom activities of competitions. 8 questions indicated fostering activities on creativity. ( see the table below)

Table 3. Survey Questions.

Foster creativity questions	Do not foster creativity questions
<ul style="list-style-type: none"> <li>• I involve multiple senses in my lessons.</li> <li>• I relate the content material in my class to real-world experiences.</li> <li>• Grades in my class are mostly based on the student having the correct answer not the correct process.</li> <li>• Competition takes place in my classroom.</li> <li>• I allow children to choose their own projects for demonstrating their knowledge.</li> </ul>	<ul style="list-style-type: none"> <li>• I keep my art materials (markers, glue, crayons, scissors, etc.) locked up and not available to the children.</li> <li>• I involve my students in a brainstorming process before starting a new project or concept.</li> <li>• I focus on topics in my classroom that the children already understand.</li> </ul>

<ul style="list-style-type: none"> <li>• My students are comfortable asking questions and making mistakes.</li> <li>• I use activities that require my students to create a solution or idea.</li> <li>• I respect the ideas of all the children present in my classroom.</li> <li>• I use ungraded assignments to allow my students to practice new material.</li> <li>• I use visualization as a technique in my classroom.</li> <li>• I encourage independent learning.</li> <li>• I provide activities that allow my students to think backwards to solve a problem.</li> <li>• I use brainteasers, word problems, and puzzles in my classroom.</li> </ul>	<ul style="list-style-type: none"> <li>• When grading student work I provide ample feedback along with the grade.</li> <li>• My students spend the majority of the day seated at their desks.</li> <li>• When I ask questions I am looking for the correct answer.</li> <li>• I show examples of someone else's work before beginning a new project.</li> <li>• I teach multiple ways of finding a solution to a problem.</li> <li>• I praise neatness and consistency.</li> </ul>
--	--

The third survey examined own classroom perceptions and practices of teaching. 4 out of 6 questions demonstrated teachers' agreement that they foster creative thinking in their particular classroom.

The third survey included some additional space for comments in order to improve understanding of the research on perceptions. Half of the comments responses included the agree category on fostering creative thinking in writing as an easy area to incorporate creativity. 20% agreed on providing chances for creativity within the activities of the classroom in writing because social studies offer less opportunities because of the curriculum plan. The third survey included question on whether teachers planned their activities for the intention to foster creative thinking. The respondents' answers were mostly negative. 34% of the respondents on commenting believe they incorporate creativity with hobbies of students and others refer to flexibility and spontaneity as features of creative thinking. Findings suggest that teachers sometimes seek answers from their students as different ideas although they may not be correct as responses. 75% of the teachers do not perceive their students as creative and that their creativity is very different.

As a conclusion, findings suggest that teachers understand and know creativity and activities related to foster it. The most part of it incorporate 30% classroom practices with creative thinking activities in the classroom.

## Discussion

The findings of research project suggest that teachers in Elbasan schools consider creative thinking very important but their activities in the classroom do not match and align with creativity. According to the first survey the activities that hinder creativity occur more often in the classroom. The second survey indicates that teachers know which activities foster creative thinking.

This study aimed to analyse if there is a match between perception of creativity and classroom activities to develop the necessary skills for it. Findings suggest that although teachers know and understand creativity importance they don't do much to separate from their daily routines on content masterization instead of focusing on activities to foster creativity.

Other findings of survey 1 and 2 include misconception some of the teachers have of creativity. On the question about the grading method teachers focused on the correct response not on the process of it. This is something that suggest that traditional methods or other factors like standard tests are yet stressed more in the classroom activities.

## Conclusion

In conclusion respondents capture the meaning of creativity as an important capability nowadays therefore the importance of it to be fostered in the classroom, nonetheless teachers state that they are not doing much to develop it. They simply take into consideration free ideas of students as a means to develop creativity but not developing it through activities planned beforehand. Albanian schools, although they have in their curricula the development of creative thinking and critical thinking and place much emphasis, they still continue to focus on masterization of material content rather than mastering it through creativity, imagination and critical thinking as the most and very useful skills to be fostered for the future of their students.

## Limitations of this Research

As the data from this study are analyzed there were many factors to be taken into consideration such as the sample especially for the first and second survey. It was difficult to contact and receive permission from the administrators of some schools for their teachers to participate in the surveys.

Another limitation is that there were no test to provide a reliable and valid administered surveys because survey were self reflected responses and there may have been bias from the part of the participants who volunteered in the surveys, thus the conclusions cannot be generalized for all schools in the city of Elbasan.

## Implications

According to results, in general teachers know the perception of creativity and understand whereas others misconcept it or have difficulty implementing it in the classroom activities. Mostly they focus on masterization of content of material instead of fostering material creative thinking. Although teachers are aware of the great importance of creativity skills in the future, they are incapable or don't know how to interact its skills with other activities in the classroom.

## Recommendations for Future Research

Studies on such topic should include more and a larger representative sample, involving more schools, levels of grade, districts and areas for findings generalized to a larger population.

According to the findings of this study there is no a significant correlation between teachers' perception of what fosters creativity and their classroom practice activities. For better and more accurate results it would have been interesting to use classroom case studies and data from observations made in the classroom to be added to the data from self-reflection survey responses.

This study included a great amount of items which might have cause the participants to respond less in the following surveys due to time of completion they might have taken.

Interesting and of great significance would have been to include data from administrators about their perception of creative thinking and also to see if they supported teachers in developing such skills as well the study should have included both administrators and teachers educational background and their particular trainings about classroom creativity fostering in order to examine the impact of these variables.

## References

- Azzam, M. A, <http://www.ascd.org/publications/educational-leadership/sept09/vol67/num01/Why-Creativity-Now%C2%A2-A-Conversation-with-Sir-Ken-Robinson.aspx>
- De Bono, E.(1982) De Bono's thinking course, BBC Books
- Harris, J. (1993). *Introducing Writing*. London: Penguin Books Ltd.

Mumford, D. (2003). Where have we been, where are we going? Taking stock in creativity research. *Creativity*

**Patel.M,<http://qep.ncsu.edu/why-is-critical-and-creative-thinking-important-to-student-success/>**

*Research Journal*, 15, 107-120. [http://dx.doi.org/10.1207/S15326934CRJ152&3\\_01](http://dx.doi.org/10.1207/S15326934CRJ152&3_01)

---

## Differential Roles between Owner and Manager in Financial Practice that Contributes to Business Success: an Analysis on Malaysian Small Business

**S. M. Ferdous Azam**

PhD Research Fellow, Department of Business Administration,  
Kulliyah of Economics and Management Sciences,  
International Islamic University Malaysia,  
[sakeeb06@gmail.com](mailto:sakeeb06@gmail.com)

**Moha A. Abdullah**

Professor, Department of Economics,  
Faculty of Economics and Management Sciences,  
International Islamic University Malaysia,  
[mosria@gmail.com](mailto:mosria@gmail.com)

### Abstract

*The purpose of this research is to assess the moderating effect of business owner and manager in financial practice towards business success in Malaysian small business. To meet the research objectives, this study employed survey method where the unit of analysis is the individual respondent consisting business owners and managers. A sample of 302 data was considered as the final sample size for the current study. Using Structural Equation Modelling (SEM), moderating effects were observed to test the hypotheses. The results indicate that, the owners and managers do have different moderating roles in financial practice to guide the business success in Malaysian small business. Thus, this research conveys an understanding to the entrepreneurs regarding the difference of ownership and managerial role to achieve the business success swiftly. Finally, the current study brings some implications to the policy makers and regulators as well.*

**Keywords:** Business Owner, Business manager, Moderating role, Financial practice, Business success, Malaysian small business

### Introduction

The Malaysian small businesses are presently having a good business and their overall performance somehow be said as expected (Khairudin, 2007; Moha Asri and Manan, 2010). Statistically, it is estimated that the share of employment by small business will increase close to 60 percent in the near future (SMEs Annual Report, 2012). Actually, the strong employment growth of small business began in 2007 at 8.3 percent, when the value added growth of small business was at its peak (SMEs Annual Report, 2012). Literatures and statistical records (Lim, 1986; Moha Asri, 1999; Salleh and Ndubisi, 2006; Alias, 2007; Moha Asri and Manan, 2010; Yusoff and Yaacob, 2010) show that the government of Malaysia did play many important roles in the past to promote small business, yet Malaysian small business can improve more than what they are performing these days. However, it might be progressed further if the role of key people involved with these businesses would be understood properly. Add to this, few elements such as entrepreneurial demographic profile, their ability and skills, characteristic traits as well as their designation are the important concerns that have an influence on proper financial practice for a small business (Adeyemo, 2009), which employ business success ultimately.

Rudmann (2008) interpreted the term entrepreneurial skills as entrepreneurial qualities and/or values. Furthermore, the term 'skills', 'expertise', 'acumen' and 'competency' are all interrelated and are sometimes used interchangeably in the

literature (Smith and Morse, 2005). Basically, these all make the entrepreneurial characteristic traits that mechanically come into contact with the financial means for the small business. Previously, Bird (1995) suggested that entrepreneurial skills like ownership skills and managerial skills can be as underlying characteristics such as generic and specific knowledge, motives, traits, self-images and social roles which result of growth and business success. A little later, Wickham (1998) added that the entrepreneurial skill means knowledge translates into the action. Most recently, Akande (2011) came up with a new understanding where the entrepreneurial skill is a quality or characteristic which needs to be possessed by entrepreneurs in starting and managing the business successfully. However, these skills can be found differently if the entrepreneurial role and authority are imposed differently (Adeyemo, 2009; Santos and Bode, 2012). At the same way, Malaysian small business may witness these different roles in terms of business owners and managers. Logically, a business owner does have more authority and freedom over business manager in operating a business. This research, therefore, investigate whether business owner and manager play different roles in financial practice towards business success in Malaysia. Moreover, this research investigates a completely different type of small business success from a different dimension, where the designation such as a business owner and manager play an important role. In this relation, this study embarks on the following objectives:

- (i) To assess the impact of designation (owner) on Financial Practice towards Business Success.
- (ii) To realize the impact of designation (manager) on Financial Practice towards Business Success.
- (iii) To enhance the new understandings and recommend some potential implications for the business success of small business in Malaysia.

### Literature Review

Small business includes all businesses and enterprises except large enterprises (Moha Asri, 1999; Moha Asri and Manan, 2010; Rosman and Mohd Rosli, 2011), because most of the businesses worldwide can be categorized as small businesses through judgmental reasoning (APEC, 2003). However, this definition also is also imposed in Malaysian perspective (Rosman and Mohd Rosli, 2011). Historically, there was no standard definition of small business used in Malaysia before the formation of the National SME Development Council (NSDC) in June 2004. Therefore, different agencies did characterize and define small business based on their own criteria, focusing on number of full-time employees and annual sales turnover mostly. According to a new definition approved recently on 11 July 2013, an enterprise with sales turnover of less than RM30 million and/or full-time employee of less than 200 in the manufacturing sector is considered small and medium size business (SME Corporation Malaysia, 2013).

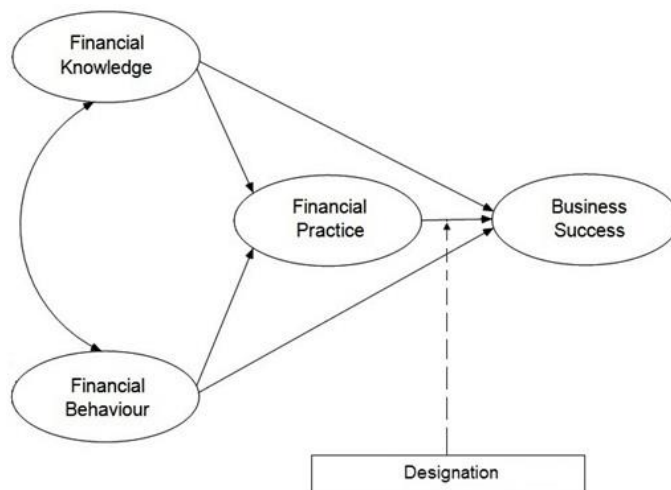
In most industrially developed and developing economies, a growing number of small businesses need to access a wide range of sources of finance for their business success (Hussain et al., 2006). For that, financial knowledge and subsequent behaviour may bring the proper financial practice that employs business success for the small business (Xiang et al., 2011). It is widely recognized in academic literature that small businesses basically struggle with access to finance (Mason and Kwok, 2010; Hughes, 2009; Guijarro, Garcia and Auken, 2009; Bruns and Fletcher, 2008; Mason and Harrison, 2004) whereby financial practice can be indicated as the main player of the whole phenomena. Actually, access to finance helps and proper financial practice creates the business growth and prosperity for the small business (Stam and Garnsey, 2008; Butler and Cornaggia, 2009). However, Malaysia as like other developing countries, small business usually faces significant barriers to finance. This happens mainly because of an individual's knowledge, actions and behaviour regarding financial practices (Guiso and Minetti, 2010; Xiang et al., 2011).

For entrepreneurial knowledge and behaviour that constitute an organization's financial practice (Bellucci, et al., 2010; Dietrich, 2010; Hamelin, 2011; Xiang et al., 2011), the demographic profile of an entrepreneur is equally considered as a crucial factor that may lead their execution aptitude towards a specific action. Regarding this, Adeyemo (2009) stated that, skill is a quality of performance that is not only depended on individual natural ability but also must be developed through training, practice and experience. Although skill depends on learning and that learning brings more knowledge, it also includes the concepts of efficiency and economy in performance and/or success in the small business context.

The entrepreneurial affiliation and designation such as business owner and manager are the key components that should be considered while the primary concern is financial practice, and these should be taken into the account in exercising

financial practice for business success. Effectively, components like entrepreneurial quality, ability, capacity, skills and overall characteristic traits derive from certain entrepreneurial features, while those typical features are the education, age, work experience and motivation (Guzman-Cuevas et al., 2009; Santos and Bode, 2012). As stated by Cooper (1985), work experience constitutes a learning process through entrepreneurial skills. This work experience can be gained from the authority and autonomy being exercised in the business enterprise either as owner or manager. These entrepreneurial skills are the basic skills necessary to enable entrepreneur to start, develop, finance and succeed in their enterprise (Adeyemo, 2009). However, Andersson and Tell (2009) focused on the firm's growth in respect with managerial traits and characteristics, managerial intentions, aspirations or motivation, as well as managerial behaviour or roles. Their conceptual model is principally based on earlier research on how owners and managers influence growth in small firms, where the direct relationship of managerial characteristic traits of business growth and success are observed.

Abu Mansor et al. (1999) explained managerial skills as the skill that is used to measure the manager's level of competency and effectiveness. According to Botha et al (2006), managerial skill involves skill in decision making, planning and strategy, human relation, finance, marketing, accounting, general management and negotiation. Likewise, Kadir and Rosli (2011) stated that, managerial skills consist of the three critical areas of skills, such as management, financial and marketing. This managerial skill is needed and also observed to the owners of the businesses as well. Therefore, when the measurement of financial practice is concerned for the business success, then the small business may scratch on management and ownership skills such as decision making ability, proper financial knowledge execution, appropriate financial behaviour and overall entrepreneurial character traits for the business success. Moreover, the difference in ownership and managerial roles still post a genuine concern in academia, which can be expressed through moderating effect. Derived from literature support and related evidences, this concern puts a conceptual framework which is exhibited in Figure 1.



**Figure 1: Conceptual Framework**

To meet the research objectives and based on the conceptual framework presented above, two hypotheses are constructed as follows:

H1: There is a moderating effect of designation (owner) on financial practice towards business success.

H2: There is a moderating effect of designation (manager) on financial practice towards business success.



## Research Methodology

The research method of this study is survey method. The survey method is the most appropriate method for the data collection as this method helps to predict the nature of the total population from which the sample are selected (Fowler, 1988; Sapsford, 1999). Survey research method often leads to achieve the accuracy and relatively cost-efficient data for the research (Sekaran, 2000; Kothari, 2004). This method can be developed in less time and able to collect data from a large number of respondents (Neuman, 2007). Besides, the unit of analysis in this study is the individual respondent, such as business owners and managers involved in Malaysian small business. The sampling frame in this study contains the small businesses that are obtained from the SME Corp Malaysia. Since about majority of all the companies are based in Selangor and the greater Kuala Lumpur region, the capital city of Malaysia, thus it also reflected in the current study as well. Hence, the overwhelming majority of the companies had chosen from the Kuala Lumpur region for the current research, though some of the divisions of these companies are scattered in various parts of Malaysia.

This research used a 5- point Likert scale for constructing the questionnaire by putting preferences to the items considered in the past studies. Moreover, a 5-point Likert scale asks respondents to provide a relative assessment of various statements in the questionnaire on a continuum ranging from 'strongly disagree' to 'strongly agree' that are very commonly used for collecting primary data in empirical research (Ward et al., 1998).

To meet the research aim, this study employed the simple random sampling technique to carry out the survey. A simple random sampling is a subset of respondents (a sample) chosen from a larger set (a population). Each respondent is chosen randomly and exclusively with probability, wherein each of the respondent does have a similar possibility of being chosen at any phase throughout the sampling process (Malhotra, 2007; Sekaran and Bougie, 2009). For this purpose, the small businesses are chosen from the sampling frame representing the population are grouped into three broad categories derived from their business operation. These are as follows:

- i. The businesses were selected did fulfil the criteria of small business and employ a regular basis operational activity.
- ii. The respondents who took part in this study comprised two categories including business owners and managers only.
- iii. The respondents of being managers, they were working as the full-time employees in the respective enterprises, and who were familiar with the financial practice and other finance related activities.

Moreover, questionnaires were only distributed to the respondents having met the above criteria. As this research employs Structural Equation Modelling (SEM), therefore, the question of sample size adequacy remained as a prime concern in the application of SEM software program. A sample of 302 data was considered as the final sample size for the current study.

As mentioned, this research employs Structural Equation Modelling (SEM) for statistical analysis of data, which is developed for analysing the interrelationships among multiple variables in a model (Zainudin, 2012). Besides, SEM techniques have been significant to confirm theoretical models for using a quantitative approach. Therefore, evaluating these circumstances, this study considers SEM as a suitable tool for analysing quantitative data in research progression.

## Findings

This section starts with demographic information of the respondents. The demographic information comprises the gender, age, race, level of education and respondents' designation in the respective company. This part, in fact, provides a detailed scrutiny of demographic information. Table 1 portrays the respondents' demographic information as a whole.

**Table 1: Demographic Information on the Research Participants**

Demographic	Frequency	Percentage
<b>Gender</b>		
Male	178	58.9
Female	124	41.1
Total	302	100.0
<b>Age</b>		
<20	21	7.0
20-29	162	53.6
30-39	79	26.2
40-49	21	7.0
≥50	19	6.3
Total	302	100.0
<b>Race</b>		
Malay	177	58.6
Indian	43	14.2
Chinese	82	27.2
Total	302	100.0
<b>Level of Education</b>		
Primary School	29	9.6
Secondary School	58	19.2
Diploma	113	37.4
Bachelor	78	25.8
Masters Degree	24	7.9
Total	302	100.0
<b>Designation</b>		
Owner	129	42.7
Manager	173	57.3
Total	302	100.0

Above Table 1 shows that, both male and female are in good numbers participating in the study. Among 302 respondents, it is observed that, 178 are male where 124 are female, which means the percentages of male and female respondents are 58.9 percent and 41.1 percent respectively. Additionally, Table 1 also shows that the age range of 20-29 years is 53.6 percent with the highest frequency of 162 and 30-39 years' age range covers 26.2 percent of total respondents having a second highest frequency of 79 out of 302. Besides, the age range of 40-49 years consists of 7.0 percent with 21 frequency as well as 50 years and above, which is coded as '≥50' includes only 6.3 percent or 19 respondents out of 302 respondents. With the age diversity among respondents, there are diverse races like Malay, Indian and Chinese are also engaged with small businesses, where the engagement of Malay, Indian and Chinese are 58.6 percent, 14.2 percent and 27.2 percent respectively. Table 1 also indicates that 177 respondents (58.6 percent) are

found Malay originated business owner or manager, while 43 respondents (14.2 percent) are Indian and another 82 respondents (27.2 percent) are Chinese. Hence, Chinese is having a better enterprise compared to Indian after Malay entrepreneurs.

Out of 302 respondents, 29 respondents (9.6 percent) passed primary school, 58 respondents (19.2 percent) completed secondary school, 113 respondents (37.4 percent) hold diploma, 78 respondents (25.8 percent) have a bachelor degree and only 24 respondents (7.9 percent) were with masters' degree with regard to educational qualification, where a total of 129 respondents (42.7 percent) are noticed as business owner, whereas 173 respondents (57.3 percent) are found as business manager among those 302 respondents.

Beside the demographic information, the company information draws an outline of a company or enterprise, which is basically a background of a venture. In this particular study, the company information indicates three major things covering types of business, length of operation and the number of employees. Table 2 presents the general information regarding the companies surveyed in the study.

**Table 2: General Information of the Companies Surveyed**

General	Frequency	Percentage
Manufacturing	78	25.8
Service	224	74.2
Total	302	100.0
<b>Length of Operation</b>		
≤2 Years	216	71.5
>2 Years	86	28.5
Total	302	100.0
<b>Number of Employees</b>		
≤5	191	63.2
>5	111	36.8
Total	302	100.0

Refer to the Table 2, the percentages of manufacturing and service industries are 25.8 percent and 74.2 percent respectively, where 78 enterprises are involved with manufacturing activities and 224 enterprises are engaged with service sectors, and there are 216 enterprises or 71.5 percent of businesses are operating their business less than two years, along with 86 enterprises or 28.5 percent of businesses are comparatively matured, having their business more than two years according to the respondents' statements. Table 2 also expresses the number of employees by definite numbers where 191 enterprises are found to have '5 employees and less', which is equivalent to 63.2 percent. On the other hand, rest of 111 enterprises (36.8 percent) are observed in the group of 'more than 5 employees' category.

After analysing the demographic and company information, the basic analysis (main model) was run via Structural Equation Modelling (SEM). In SEM, it is important to decipher whether, besides the main model, any other alternative or competing models cause of the moderating effects highlighting different speculative relationships among the latent constructs, offers better explanations of the phenomenon under study. The singular purpose is to compare these competing models derived by modifying the relationships either through segregating the groups or omission of paths (Hair *et al.*, 2010). For this, the difference in Chi Square (ChiSq or  $\chi^2$ ) test between two competing models is used to calculate improvements over competing models; significant results for the Chi Square (ChiSq or  $\chi^2$ ) difference test indicate that the model with smaller Chi Square (ChiSq or  $\chi^2$ ) has a statistically better fit (Milfont and Fischer, 2010). This is done, where the Chi Square (ChiSq or  $\chi^2$ ) fit statistic is compared by difference in Chi Square (ChiSq or  $\chi^2$ ) statistic such that ' $\Delta\chi^2_{(df)}$ '

$df_2 = \chi^2_{(df_1)} - \chi^2_{(df_2)}$ , which is distributed as a chi-square distribution with  $df = df_1 - df_2$  (Mueller and Hancock, 2007, p. 501).

However, one of the objectives of this research is to discover whether there is any significant difference between the different designation such as enterprise owners and managers of the small business in understanding the relationship of financial practice and business success. To observe the moderating impact, SEM pursues a specific way to process the analysis. Initially, split of data is necessary into separate gatherings and spared into groups and this has to be saved in the different group name. At that point, two different models are produced utilizing two different data sets, where it needs to label with different names and there if there is no significant differences found between the models, it should go to the next stage of invariance analysis. After that, with getting the Chi Square ( $\chi^2$ ) value for both the constrained and unconstrained models with respect to the Degrees of Freedom (df), the analysis computes whether the difference between the Chi Square ( $\Delta\chi^2$ ) and Degrees of Freedom is significant. If the difference seems significant, then it is clear that there is a difference between the two groups. On the other hand, if it is not significant, then those two models are identical and the nature of the respondent does not work as moderator in the model.

These phenomena, however, have been primarily tested by the following Figure 2 (a) and Figure 2 (b), which portray the unique response of the two groups of respondents in terms of their designation in the small business in Malaysia, namely enterprise owners and managers.

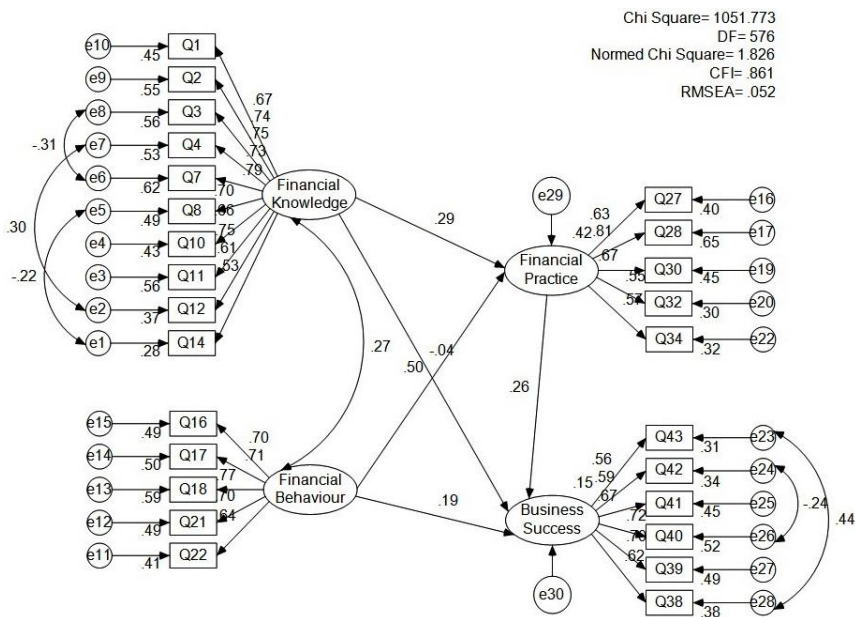


Figure 2 (a): Unique Response of Owners on the Hypothesized Model

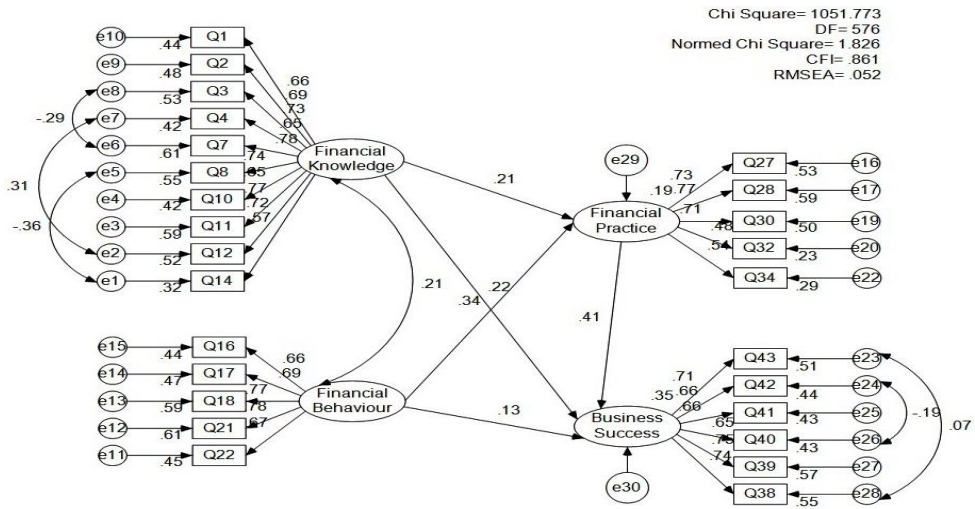


Figure 2 (b): Unique Response of Managers on the Hypothesized Model

Since both of these Figure 2 (a) and Figure 2 (b) show the same Chi Square (ChiSq or  $\chi^2$ ), Degrees of Freedom (df), Normed Chi Square (ChiSq/df), CFI and RMSEA values, thus, no clear sign of having a moderating effect is observed. For this reason, it requires a move to the next stage of invariance analysis (Zainudin, 2012), allowing for both constrained and unconstrained models to figure it out whether the change of Chi Square (ChiSq or  $\chi^2$ ) and the Degrees of Freedom (df) is significant between these two groups. According to Zainudin (2012), if the Chi Square (ChiSq or  $\chi^2$ ) value changes between constrained and unconstrained models by more than 3.84 for 1 Degree of Freedom (df), then the moderation occurs in that particular path. In this research, however, a parameter constraint is put on the selected path (Financial Practice  $\rightarrow$  Business Success) to be equal to 1 as suggested by Zainudin (2012). Therefore, the Figure 3 (a) and Figure 3 (b) demonstrate the output for the constrained model and unconstrained model respectively for the enterprise owners.

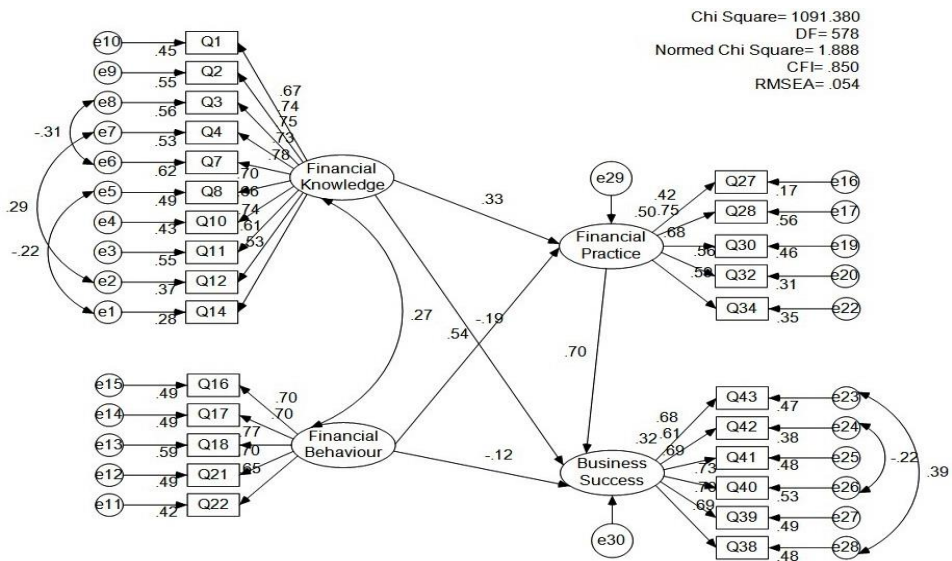


Figure 3 (a): Owners' Output for the Constrained Model

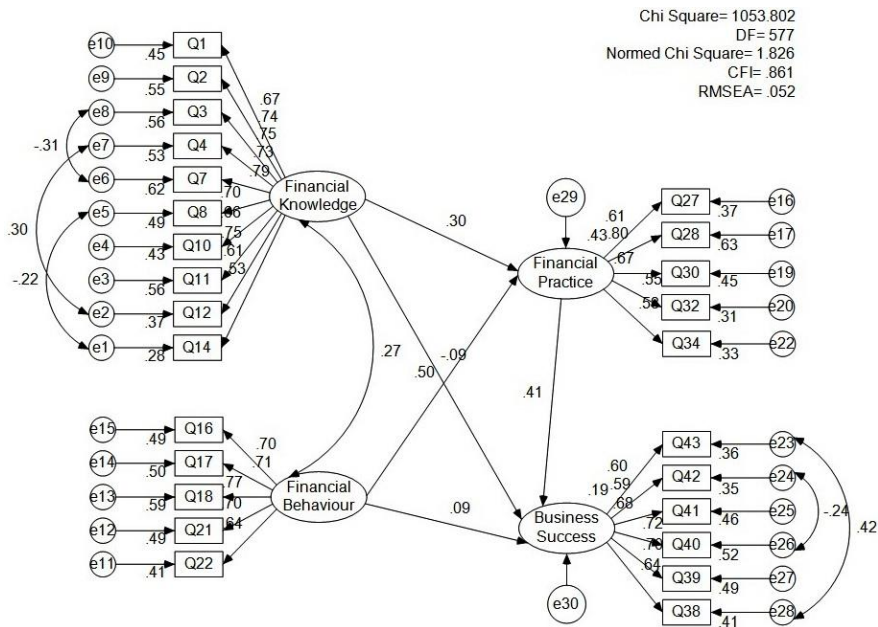


Figure 3 (b): Owners' Output for the Unconstrained Model

After this step of constrained model and unconstrained model analyses as shown in Figure 3 (a) and Figure 3 (b), now the different Chi Square (ChiSq or  $\chi^2$ ), Degrees of Freedom (df), Normed Chi Square (ChiSq/df), CFI and RMSEA values are found. As a rule of thumb set by Zainudin (2012), the moderation happens in a particular path if the Chi Square (ChiSq or  $\chi^2$ ) value changes above than 3.84 for 1 Degrees of Freedom (df) from the constrained model to the unconstrained model. However, following Table 3 shows the moderation test for enterprise owners' group data.

Table 3: Moderation Test for Enterprise Owner

	Constrained Model	Unconstrained Model	Chi Square Difference ( $\Delta\chi^2$ )	Result in Moderation	Result on Hypothesis
			$[\chi^2_{(df1)} - \chi^2_{(df2)}]$		
Chi Square (ChiSq or $\chi^2$ )	1091.380	1053.802	37.578	Significant	Supported
Degrees of Freedom (df)	578	577	1		
Normed Chi Square (ChiSq/df)	1.888	1.826			
CFI	0.850	0.861			
RMSEA	0.054	0.052			

The Hypothesis Statement:

Supported

H1: There is a moderating effect of designation (owner) on financial practice towards business success.

The above Table 3 indicates that the moderation test is significant since the difference in Chi Square ( $\Delta\chi^2$ ) value between the constrained and unconstrained model is greater than 3.84. Actually, the difference in Chi Square (ChiSq)

value is 37.578 (1091.380 – 1053.802), while the difference in Degrees of Freedom is 578 – 577 = 1. Therefore, the hypothesized statement is supported. This is actually supported by Adeyemo (2009), who mentioned that the enterprise owners' profile, ability and skills, are the influential aspects that have a control on financial practice. In effect, components like entrepreneurial quality, ability, capacity, skills and overall characteristic traits are derived from certain owners' demographic features (Guzman-Cuevas et al., 2009; Santos and Bode, 2012). So, the result found from the Malaysian data is actually supporting the past literatures conducted in various businesses, while this research is evaluating small business in Malaysia.

On the other hand, as like constrained model and unconstrained model for the enterprise owners plotted in Figure 3 (a) and Figure 3 (b), the managers' constrained model and unconstrained model need to be tested subsequently since no clear indication was noted for a moderation effect from Figure 2 (a) and Figure 2 (b), seeing that the Chi Square (ChiSq or  $\chi^2$ ), Degrees of Freedom (df), Normed Chi Square (ChiSq/df), CFI and RMSEA values were same between the groups. As a result, it calls for a further progress to the next stage of invariance analysis (Zainudin, 2012), addressing the both constrained and unconstrained models to observe whether the change of Chi Square (ChiSq or  $\chi^2$ ) and the Degrees of Freedom (df) is significant. Therefore, a parameter constraint is put on the selected path (Financial Practice→Business Success) in the same way done before, where the parameter was fixed equal to 1 as suggested by Zainudin (2012). However, the Figure 4 (a) and Figure 4 (b) display the output for the constrained model and an unconstrained model for the enterprise manager respectively.

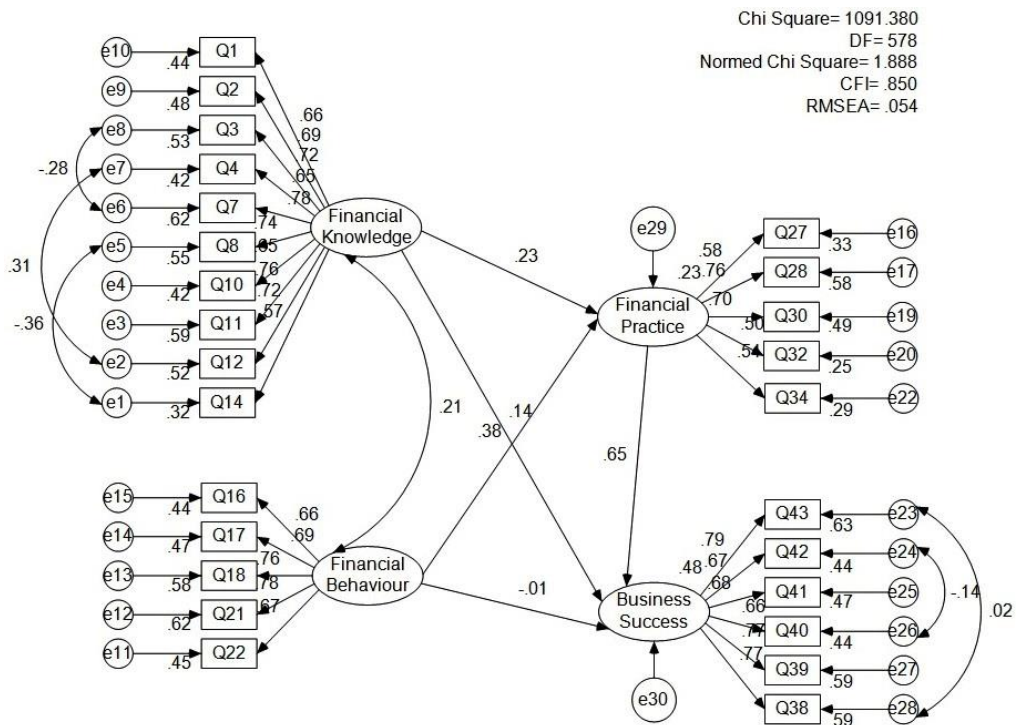


Figure 4 (a): Managers' Output for the Constrained Model

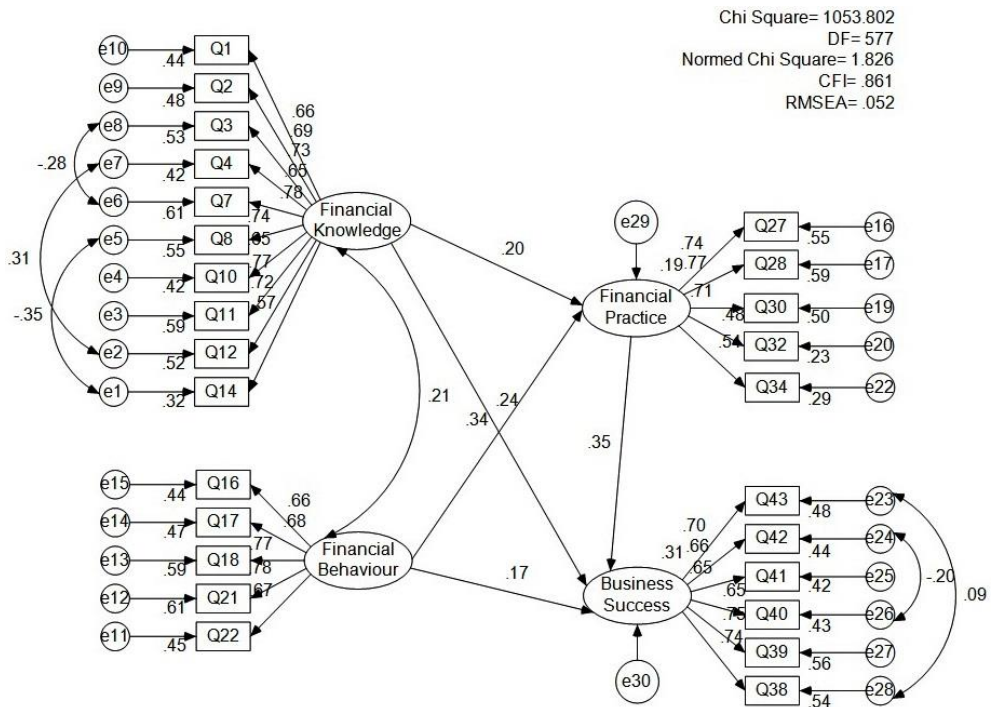


Figure 4 (b): Managers' Output for the Unconstrained Model

Just like previous analysis based on enterprise owner's, this step of constrained model and unconstrained model analyses also shows the different values for the Chi Square (ChiSq or  $\chi^2$ ), Degrees of Freedom (df), Normed Chi Square (ChiSq/df), CFI and RMSEA as shown in Figure 4 (a) and Figure 4 (b). However, following Table 6.15 shows the moderation test for enterprise managers' group data.

Table 4: Moderation Test for Enterprise Manager

	Constrained Model	Unconstrained Model	Chi Square Difference ( $\Delta\chi^2$ ) [ $\chi^2_{(df1)} - \chi^2_{(df2)}$ ]	Result in Moderation	Result on Hypothesis
Chi Square (ChiSq or $\chi^2$ )	1091.380	1053.802	37.578	Significant	Supported
Degrees of Freedom (df)	578	577	1		
Normed Chi Square (ChiSq/df)	1.888	1.826			
CFI	0.850	0.861			
RMSEA	0.054	0.052			

The Hypothesis Statement:

Supported

H2: There is a moderating effect of designation (manager) on financial practice towards business success.



One thing should be noted, although Table 3 and Table 4 exhibit similar results as well as given four figures such as Figure 3 (a), Figure 3 (b), Figure 4 (a) and Figure 4 (b) look like comparable, however, these all are unique since their path coefficients are different. From those path coefficients, actually the influences of the constructs can comprehend accordingly.

Observing the values from Table 4 above, it can be said that the moderation test is significant since the difference in Chi Square ( $\Delta\chi^2$ ) value between the constrained and unconstrained model is greater than 3.84 (Zainudin, 2012). Specifically, the difference in Chi-Square (ChiSq) value is 37.578 (1091.380 – 1053.802), while the difference in Degrees of Freedom is 578 – 577 = 1. Therefore, the hypothesized statement is supported. Actually, some effective components like managerial quality, aptitude, capability, skills and overall characteristic traits derive from certain managerial demographic features (Abu Mansor et al., 1999; Bailey and Mitchell, 2007), those have an ultimate influence of having business success for the enterprise (Akande, 2011; Santos and Bode, 2012).

With these, therefore, it has been proved that there is a moderating effect of designation (owner and manager) on financial practice towards business success. In fact, previous scholarly works (Bellucci, et al., 2010; Dietrich, 2010; Hamelin, 2011; Haque, Rahman and Azam, 2011; Xiang et al., 2011) also support these findings that the owners and managers' diversified financial knowledge constitute an enterprise's financial practice wherein the demographic factors of the enterprise owners and managers' are uniformly considered as a crucial factor that may lead their business to be successful. In addition to this, owners and managers' skills are sort of 'quality of performance', which is not only depends on individual natural ability but also must be developed through training, practice and experience (Moha Asri, 1998; Adeyemo, 2009; Azam, Haque, Sarwar and Anwar, 2014). Although skill depends on learning and that learning brings more knowledge, it also includes the concepts of efficiency and economy in performance and/or success in the SMEs context.

## Discussion and Conclusions

This study attempts to assess the moderating effect to test whether business owner and manager play different roles in financial practice towards business success in Malaysian small business. As mentioned earlier, the entrepreneurial quality, ability, capacity, skills and overall characteristic traits are derived from certain owners' demographic features (Adeyemo, 2009; Guzman-Cuevas et al., 2009; Santos and Bode, 2012), where a useful planned decision is thought as a centre of a firm's success (Olson et al., 2007). Usually, enterprise owners and managers are not found on the same boat since their decision making capacity does vary as well as the authority of leadership usually kept for the owners. However, the managers of an enterprise are considered as a substitute leader sometime, assuming to have better and more comprehensive decision maker (Lampikoski and Emden, 1999; Farrell et al., 2005), but according to findings, this phenomenon does not normally work in Malaysia. The result found from the Malaysian data is actually supporting many of the past literatures (Berry and Perren, 2001; Farrell et al., 2005; Gabrielsson, 2007; Olson et al., 2007; McCabe and Nowak, 2008; Boxer et al., 2013) in small businesses. Therefore, the hypothesized statements are supported, saying that the owners and managers' different moderating roles compose an enterprise's financial practice to guide the business success in the long run (Gabrielsson, 2007; Bellucci, et al., 2010; Dietrich, 2010; Hamelin, 2011; Boxer et al., 2013), which is true for Malaysia as well. However, this research used a valid and reliable instrument to measure the moderating effect to test whether business owner and manager play different roles in financial practice towards business success in Malaysian small business. Therefore, this study significantly contributed in the methodological development in the Malaysian small business. Conversely, on the practical execution level of financial matters, this study mainly focuses on individuals (owners and managers) those who directly and indirectly handle the financial substances. As mentioned earlier, the respondents of this research were the enterprise owners and managers to get the internal, financial and operational information. This will definitely increase the efficiency which would be the ultimate step for business win for any business, as to small business in Malaysia.

## References

Abu Mansor, A., Ahmad, F., Din, M., Hanissah A. R, & Mohd Noor, N. A (1999). *Pengantara Pengurusan*. Sintok: Universiti Utara Malaysia.

- Adeyemo, S. A. (2009). Understanding and acquisition of entrepreneurial skills: A pedagogical re-orientation for classroom teacher in science education. *Journal of Turkish Science Education*, 6 (3), 57-65
- Akande, O. O. (2011). Accounting skills as a performance factor for small businesses in Nigeria. *Journal of Emerging Trends in Economics and Management Sciences*, 2 (5), 372-378. Retrieved May 16, 2013, from: [www.jetems.scholarlinkresearch.org](http://www.jetems.scholarlinkresearch.org)
- Alias, A. (2007). Entrepreneur and entrepreneurship *Fundamentals of Entrepreneurship*. Petaling Jaya: Prentice Hall.
- Andersson, S., & Tell, J. (2009). The relationship between the manager and growth in small firms. *Journal of Small Business and Enterprise Development*, 16 (4), 586 - 598.
- APEC. (2003). What is an SME? SME definitions and statistical issues. *Journal of Enterprising Culture*, 11(3), 173-183.
- Azam, S. M. F., Haque A., Sarwar, A. and Anwar, N. (2014), "Training Program Effectiveness of Service Initiators: Measuring Perception of Female Employees of Bank Using Logistic Approach", *Asian Research Journal of Business Management*, Vol. 2 No.1, pp.98-108
- Bailey, J., & Mitchell, R. B. (2007). Industry perceptions of the competencies needed by computer programmers: technical, business, and soft skills. *Journal of Computer Information Systems*, (Winter), 28-33.
- Bellucci, A., Borisov, A. & Zazzaro, A. (2010). Does gender matter in bank-firm relationships? Evidence from small business lending, *Journal of Banking & Finance*, 34, 2968-2984.
- Berry, A. and Perren, L., (2001), "The role of non-executive directors in UK SMEs", *Journal of Small Business and Enterprise Development*, Vol. 8 Iss 2 pp. 159-173
- Bird, B. (1995). *Toward a theory of entrepreneurial competency*. In Katz, J.A. and Brockhaus, R.H. (Ed.) *Advances in Entrepreneurship, Firm emergence, and Growth*, JAI Press, Greenwich, CT, 2, 51-72.
- Botha, M, Nieman, G., & Vuuren, J. V. (2006). Enhancing female entrepreneurship by enabling access to skill. *EntrepreneurshipManagement*, 479-493.
- Boxer, R., Perren, L. and Berry, A., (2013), "SME top management team and non#executive director cohesion", *Journal of Small Business and Enterprise Development*, Vol. 20 Iss 1 pp. 55 – 79
- Bruns, V., and Fletcher, M. (2008). Banks' risk assessment of Swedish SMEs. *Venture Capital*, 10 (2). pp. 171-194.
- Butler, A., & Comaggia, J. (2009). Does access to external finance improve productivity? Evidence from a natural experiment. *Journal of Financial Economics*, 99 (1), 184-203.
- Cooper, A C. (1985). The role of incubator organizations in the founding of growth- oriented firms. *Journal of Business Venturing*, 1 (1),75-86.
- Dietrich, A. (2010). Explaining loan rate differentials between small and large companies: evidence from Switzerland, *Small Business Economics*, DOI: 10.1007/s11187-010-9273-8.
- Farrell, J.B., Flood, P.C., Mac Curtain, S., Hannigan, A., Dawson, J. and West, M. (2005), "CEO leadership, top team trust and the combination and exchange of information", *Irish Journal of Management*, Vol. 26 No. 1, pp. 22-40.
- Fowler, F. J. (1988). *Survey research methods*. California: Newbury Park, Sage.
- Gabrielsson, J. (2007), "Boards of directors and entrepreneurial posture in medium-sized companies", *International Small Business Journal*, Vol. 25 No. 5, pp. 511-37.
- Guijarro, A., Garcia, D. and Auken, H., (2009). Barriers to Innovation among Spanish Manufacturing SMEs. *Journal of Small Business Management*, 47 (4), 465–488.
- Guiso, L & Minetti, R. (2010). The structure of multiple credit relationships: evidence from U.S firms, *Journal of Money, Credit & Banking*, 42(6), 1037-1071.

- Guzman-Cuevas, J., Caceres-Carrasco, R., & Riberio-Soriano, D. (2009). Functional dependence and productive dependence of SMEs. *Small Business Economics*, 32 (3), 317-330. Retrieved December 12, 2012, from: [www.mpra.ubunimuenchen.de/4394/1/MPRA-paper-4394.pdf](http://www.mpra.ubunimuenchen.de/4394/1/MPRA-paper-4394.pdf)
- Hamelin, A. (2011). Small business groups enhance performance and promote stability, not expropriation. Evidence from French SMEs, *Journal of Banking & Finance*, 35, 613-626.
- Haque, A., Rahman, S., and Azam, S. M. F. (2011), "Application of Ethics in Small Enterprise: An Empirical Study on Dhaka City in Bangladesh". *Indian Journal of Management*, Vol.4 No.3, pp.45-51
- Hughes, A. (2009). Hunting the shark: some reflections on the UK experience of support for the small business sector. *Innovation: Management, Policy and Practice*, 11 (2), 114-26.
- Hussain, J., Millman, C., & Matlay, H. (2006). SME financing in the UK and in China: a comparative perspective. *Journal of Small Business and Enterprise Development*, 13 (4), 584-599. Retrieved February 20, 2013, from: [www.emeraldinsight.com/1462-6004.htm](http://www.emeraldinsight.com/1462-6004.htm)
- Kadir, S. A., & M. Rosli, M. (2011). Managerial skills of the small indigenous entrepreneurs in Malaysia. *International Journal of Business and Social Science*, 2 (10), 209-217.
- Khairudin, H. (Ed.). (2007). *Small and Medium-sized Enterprises Development in Malaysia: Programs and evaluation*. Sintok: Universiti Utara Malaysia.
- Kothari, C. R. (2004). *Research Methodology: Methods and Techniques* (2<sup>nd</sup> ed.). New Delhi: New Age International Publishers.
- Lampikoski, K. and Emden, J.B. (1999), *Managing Innovatively: Exploit Creative Resources*, WSOY, Porvoo.
- Lim, C. P. (1986). *Small Industry in Malaysia*. Kuala Lumpur: Berita Publishing Sdn Bhd.
- Malhotra, N. K. (2007). *Marketing Research: An Applied Orientation*. 5th ed., Upper Saddle River, NJ: Prentice-Hall.
- Mason, C., & Harrison, R. (2004). Business angel networks and the development of informal venture capital market in the UK: is there still a role for public policy? *Small Business Economics*, 9, 111-123.
- Mason, M., & Kwok, J. (2010). Investment readiness programmes and access to finance: a critical review of design issues. *Local Economy*, 25 (4), 269-292.
- McCabe, M. and Nowak, M., (2008), "The independent director on the board of company directors", *Managerial Auditing Journal*, Vol. 23 Iss 6 pp. 545-566
- Moha Asri, Abdullah and Siti Khadijah A. Manan (2010). Adequacy of Financial Facilities for Small-Medium Businesses: Empirical Findings from Malaysia. *Journal of International Review of Business and Research Papers*. 6 (4), 535-548.
- Moha Asri, Abdullah. (1998). Perception of the Entrepreneurs of Small-Medium Industries towards Training in Malaysia. *Industry and Higher Education*. Vol. 12, pp.115-122.
- Moha Asri, Abdullah. (1999). *Small and Medium Enterprises in Malaysia: Policy Issues and Challenges*, Vermont, Ashgate.
- Neuman, W. L. (2007). *Basic of Social Research: Qualitative and Quantitative Approaches* (2<sup>nd</sup> ed). New York: Pearson Education, Inc.
- Olson, B.J., Parayitam, S. and Bao, Y. (2007), "Strategic decision: the effects of cognitive diversity, conflict and trust on decision outcomes", *Journal of Management*, Vol. 33 No. 2, pp. 196-222.
- Rosman, M., & Mohd Rosli, M. (2011c). *Perusahaan Kecil dan Dilema Usahawan Melayu*. Kuala Lumpur: Penerbit Universiti Malaya.

- Rudmann, C., (2008), *Entrepreneurial Skills and their Role in Enhancing the Relative Independence of Farmers. Results and Recommendations from the Research Project Developing Entrepreneurial Skills of Farmers*. Research Institute of Organic Agriculture, ISBN 978-3-03736-028-6, Frick, Switzerland.
- Salleh, A. S., & Ndubisi, N. O. (2006). An Evaluation of SME Development in Malaysia. *International Review of Business Research Papers*, 2(1), 1-14.
- Santos, F M., & Bode, C. S. (2012). *The organizational foundations of corporate social entrepreneurship* Working Paper. Retrieved March, 20, 2013, from: <http://www.insead.edu/facultyresearch/research/doc.cfm?did=51663>
- Sapsford, R. (1999) *Survey Research*. London: Sage.
- Sekaran, U. (2000). *Research Methods for Business: A Skill Building Approach* (3rd Ed). New York: John Wiley & Sons.
- Sekaran, U. and Bougie, R. (2009). *Research methods for business: a skill-building approach* (5<sup>th</sup> ed.). Haddington: John Wiley & Sons.
- SME Annual Report. (2012). Retrieved April 1, 2013, from: [http://www.smeinfo.com.my/index.pbp?option=com\\_content&view=article&id=1415&Itemid1312&langen](http://www.smeinfo.com.my/index.pbp?option=com_content&view=article&id=1415&Itemid1312&langen)
- SME Corporation Malaysia. (2013). Retrieved May 11, 2013, from: <http://www.smeinfo.com.my/index.pbp/en/sme-definition/developing-malaysian-smes/importance-of-smes>
- Smith, B., & Morse, E. (2005). *Entrepreneurial competencies: literature review and best practices*, Small Business Policy Branch, Industry Canada, Ottawa
- Stam, E., & Garnsey, E. W. (2008). *Entrepreneurship in the Knowledge Economy*. Centre for Technology Management (CTM) Working Paper, No. 2007/04. Retrieved September, 2012, from: <http://dx.doi.org/10.2139/ssm.1923098>
- Ward, P. T., McCreery, J. K., Ritzman, L. P., & Sharma, D. (1998). Competitive Priorities in Operations Management. *Decision Sciences*, 29 (4), 1035-1046.
- Wickham, P. A. (1998). *Strategic entrepreneurship: A decision-making approach to new venture creation in management*. London: Pitman.
- Xiang, D., Worthington, A. C & Higgs, H., (2011). Firm-level determinants and impacts of finance-seeking behaviour and outcomes for small and medium-sized enterprises (SMEs) in Australia. Discussion Papers in Finance: 201115, Griffith University, Department of Accounting, Finance and Economics.
- Yusoff, M. H. And Yaacob, M. R., (2010). The Government Business Support Services in Malaysia: The Evolution and Challenges in the New Economic Model, *International Journal of Business and Management*, 5 (9), 60-71.
- Zainudin, A. (2012). *A Handbook on SEM: Structural Equation Modelling Using Amos Graphics* (4<sup>th</sup> ed.). Kelantan: University Technology MARA Press.

---

## Polysemy and Homonymy Seen in Their Stylistic Use

Sonila Daiu, PhD. Cand.

"Aleksander Xhuvani" University

sonilatanku@yahoo.com

### Abstract

*This article is concerned with stylistic phenomenon of polysemy and homonymy. Treated together they represent not only a complex linguistic phenomenon but also a stylistic one, which deserves proper treatment. In this article we mainly deal with the main sources of polysemy and homonymy in both English and Albanian Language in order to have a better understanding within the stylistic use. Using the comparative approach, we have tried to group the main sources of polysemy and homonymy, illustrated with examples.*

**Keywords** : polysemy, homonymy, stylistic, lexical – grammatical ,phonetic ambiguity, grammatical ambiguity, lexical ambiguity

### I. Introduction

The study of semantic issues, especially polysemy and homonymy, is seen in a continuing conflict between theories and arguments of different researchers, who always pose themselves in two directions. On the one hand, are those researchers who concentrate their studies in meaning only within the language, and the relation the meaning has with other linguistic elements. On the other hand, are the arguments that meaning must be studied in a non-linguistic macrostructure, where pragmatic elements play a very important role.

For example, stylistic in itself is not interested in meaning, as it is defined in some linguistic theories or shown in dictionaries. Discourse is related to the actual meaning, that which is produced from the discourse text, with the contextual meaning, with additional meaning that is obtained from the whole structural organizational of meaning, and in the end with special meanings of a speaker<sup>1</sup>. Therefore, we must admit that, except linguistic semantic polysemy and homonymy, there exist a stylistic polysemy and homonymy which is obtained from stylistic organization.

Polysemy and homonymy may rarely cause problems in communication, because the words are used in contexts, which give a lot of data to select the right meaning. Anyhow, most of the time they are used to cause ambiguity as play of words from different authors.

Ambiguity itself represents a kind of hesitation from the listener or the speaker on the selection of the two or more possible meanings that can come from the context. Ambiguity is related to the multiple meaning and give results only when the context is unclear or inadequate to make the right selection.

All words, except some technical or scientific terms, specific nouns and a small number of general nouns which refer to unique objects, mark not an individual unit, but a group of objects or events related with a common element<sup>2</sup>. Always a kind of generalization must be noted as an inevitable way of elements of ambiguity and uncertainty.

Furthermore, words that we use while we talk are not completely homogeneous from meaning: they carry a variety of aspects and patterns depending on the context and situation, and on the speakers' personality. This changes while speaking are the cause of ambiguity 'birth' and in extreme situations of disambiguation.

The nature of outside world can become a source of ambiguity. In our everyday life and environment around us, occur phenomena which melt together and are undifferentiated and we need to divide them in more differentiated units.

---

<sup>1</sup> Lloshi, Xh. (2001), *Stilistika E gjuhës Shqipe dhe Pragmatika*, SHBLU, Tiranë, pg.. 130

<sup>2</sup> Jackson, H. And Amvela, Z.E. ( 2007), *Words, Meanings and Vocabulary, An Introduction to Modern Lexicology*, 2<sup>nd</sup> Edition, Athenaeum, London, pg. 62

This lack of division, is more 'highlighted' when we deal with abstract phenomena, which themselves do not have a real existence except the words which mark them.

Another variable factor based on person's knowledge and interest, is not knowing the referent. Since, the vocabulary of a language is an open system, which means it can always have new 'flows', and moreover what it is to be mention is the fact that no one is specialized in all fields, and none can pretend to know all the words of a language. This is one of the causes not only of ambiguity but also of the interruption in a ongoing communication.

According to Wellman, "*ambiguity is a linguistic condition which may appear in different ways*". This means, that ambiguity may appear in different linguistic levels as that of phonetic, morphologic, syntax, semantic and pragmatic. All of these fall in three main categories: phonetic, syntax and linguistic ambiguity.

## II. TYPES OF AMBIGUITY

### A. PHONETIC AMBIGUITY

Phonetic ambiguity was born in spoken language, due to the phonetic structure of the sentence, for example in English language the word *near* once have had the meaning kidney, but this word was not used anymore with this meaning because a *near* – a kidney most of the time was confused with the word an ear.

In Albanian also, the accent as an essential element of how a word sounds, performs a variety of functions; among others, marks the divided border between words<sup>2</sup>.

Phonetic ambiguity it is not only related to prose features. Another source are the homophones or partial homophones, which are used for stylistic reasons. Here we can mention some examples of William Shakespeare, who used the word power in both shape and meaning, to play and create purposeful ambiguity.

King Claudius

But now my cousin Hamlet, and my **son (1)**,

Hamlet

[Aside] A little more than **kin (2)**, and less than **kind (2)**

King Claudius

How is it that clouds still hang on you?

Hamlet

Not, so my lord; I am too much **i' the sun (1)**

(Hamlet, Act I, Scene II<sup>3</sup>)

The phonetic ambiguity is created from the homophone 'son' – "i biri" and 'sun' – "dielli" and in the second case from the similarity of forms and meaning kin- "i afërt" nga lidhje farafisnore", and kind – "i dashur" and "i të njëjtit lloj apo soj". All the word-game lies in the fact that Hamlet says to his uncle that we are very close relatives, but not of the same kind (kin) and (kind). On the other hand, with homophone 'sun' and 'son' the possible meanings that come up within the same context are: firstly, it suggests his relative relation, who has replaced his father; secondly, in lighting of presence and king's well-behaviour; thirdly the sun is the kingdom emblem.

Another writer who uses the words-game skilfully as Shakespeare did is Luis Carol, in his well-known work "Alice's Adventures in Wonderland". The writer describes his work as a kind of play, in the way all Alice's adventures will be in this

<sup>1</sup> Wellman, S. (1962), Semantics : An Introduction to science of meaning, Barnes & Nobles, pg. 156

<sup>2</sup> Memushaj, R. (2006), Hyrje në Gjuhësi, TOENA, pg. 115

<sup>3</sup> Shakespeare, W. (1599), Hamlet, <http://www.feedbooks.com>

world. Character's names, places' names, subjects' names and the failure on using the linguistic rules, is in compliance with this world totally different to the real one.

We bring the example of the phonetic ambiguity:

"And how many hours a day did you do **lessons**?" said Alice, in a hurry to change the subject.

"Ten hours the first day," said the Mock Turtle: "nine the next and so".

"That's the reason they're called **lessons**," the Gryphon remarked: "because they **lessen** from day to day".<sup>1</sup>

(Chapter IX. The Mock Turtle's Story, fq.45)

Homophones lesson – "mësim" and "lessen" – "zvogëlohen" produce the same context, with two different meanings, where the explanation is given why they are called "mësim" and why they "zvogëlohen" every day.

"You promised to tell me your history, you know," said Alice, "and why it is you hate - C and D," she added in a whisper, half afraid that it would be offended again.

"Mine is a long and a sad **tail**!" said the Mouse, turning to Alice, and sighing.

"It is a long **tail**, certainly," said Alice, looking down with wonder at the Mouse's tail; "but why do you call it sad?" And she kept on puzzling about it while the mouse was speaking, so that her idea of the **tail** was something like that....

(Chapter III. A Caucus – Race and A Long Tale)

The misunderstanding that happens between Alice and the Mouse comes as the result of the use of two homophones 'tale' – "përrallë" and 'tail' – "bisht". When the mouse says my story is "rrëfenjë" long and sad Alice misunderstands, looking at his "bishti" and wondering why was sad, because ...long, of course it was, this was clearly seen.

## B. GRAMMATICAL AMBIGUITY

Another big group is the ambiguity created by the effect of grammatical elements, where we distinguish ambiguity of grammatical forms or that of sentence structure. Some prefixes and suffixes have more than one meaning, what creates not only a homonymic relation, but also the 'birth' of ambiguity, otherwise known like morphologic homonymy, in which the group includes cases where homonymic prefix in1 – "brendësi, përfshirje" and in2 – "parashtese mohore" are two group of words with opposite meaning. In the first meaning, income – "të ardhura", inland – "në brendësi", on the other case the second meaning is formed with words like this: incomplete – "i paplotë", invariable – "i panndryshueshëm", inexperienced – "papërvojë". But we have some other words where in- does not have a negative meaning, in contrary it reinforce more the meaning of the word. Also it exist the suffix – less – with a negative, childless – "pa fëmijë", hopeless – "i pashpresë" and positive meaning as well as in words: priceless – "i paçmueshëm".

Oscar Wild through distorting the rules of word formation in English, presents the school subjects like follows:

"**Reeling** and **Writhing**, of course, to begin with," the Mock Turtle replied; "and then the different branches of Arithmetic – **Ambition, Distraction, Uglification, and Derision.**"

(Chapter IX. The Mock Turtle's Story, pg.44)

In the subject of reading from the word *reading* is created a new word almost similar to it *reeling* – "përdredhje". As it is an old published book, based on word etymology this might have been used with an old meaning "*flet pa pushim*". In writing from the word *writing* we have the word *writhing* – "përdredhje". In Maths the addition word is done ambition – "qëllim", subtraction has become distraction – "zbavitje", *uglification* – "shëmtim" into multiplication – "shumëzim" and *derision* – "përqeshje" and *devision* – "pjestim".

<sup>1</sup> Caroll, L "Alice's Adventure in Wonderland", <http://www.gutenberg.org/files/11/11-pdf.pdf>

In English, structural ambiguity is more highlighted because of the morphologic characteristics of the language, lexical units often change their lexical-grammatical category, especially the noun and verb. Also the past tense forms correspond to the participles, explored forms must have different functions within a sentence. This “ambivalence” of lexical – grammatical category in English, and not so common in Albanian language, leads to creation of ambiguity.

“Now , I give you fair warning,” shouted the Queen, stamping on the ground as she spoke; “ either you or your head must be **off** , and that is about half no time!Take your choice!”

(Chapter IX. The Mock Turtle’s Story, pg. 44)

Syntax ambiguity is fully used in humorous parts, but must be found also in different artistic writings or different authors. Continuing with the examples illustration, we can identify the stylistic use.

Guildenstern

*What should we say, my lord?*

Hamlet

*Why, anything, but the purpose. You were sent for;*

( Hamlet,Act II, Scene II)

Hamlet’s answer related to what Guildenstern asks him, must be interpreted in two ways : he must say everything except the purpose why he was sent, or he must say everything, but only regarding the scope that he was sent.

### C. LEXICAL AMBIGUITY

Meanwhile, the most important group of ambiguity is the group which is created as a result of lexical factors. In an infinite number of occasions, we have different meanings related to the same word. This happens because the meaning of the word does not show only its relation with an aspect of the real world. Indeed, it might be taken as a result of semantic features derived from affiliation of speech in one or more lexical systems.<sup>1</sup>

This “polyvalence” of words must be displayed in two different forms, where the same word must have two or more different meanings; or two or more different words must have the same phonetic form, the case of homonymy.

Polysemy as well as homonymy broke one of the main rules of language , where the sign language is a unity of the signified and signifier that the speakers have in their brains<sup>2</sup>.The relation between them is that it can’t be a signified without a signifier and vice-versa, the same as a sheet that if ripped, both sides rip simultaneously. In the case of homonymy we have one responsible signifier for some signifiers and on the other hand in polysemy we have one signified expressed by some signifiers.

Polysemy as well as homonymy, are a rich source of expressions we provide in speech. Polysemy includes in itself a lexical paradigm that within the sentence is obtained one of the meanings. But, some authors are aware of breaking this rule and in the same context come out two or more lexical paradigm. On the other hand homonymy is a false polysemy, as we have the same form, but different meanings, that not only are different in meaning but also different lexemes.

Even though that polysemy is widespread in both English and Albanian language, related to homonymy, in everyday communication is almost invisible. In English language this is a frequent occurrence and this the reason why the use of homonyms is so common in English literature. Focusing in Albanian language homonymy has not been seen as a tool to express different ideas in a speech, except the case of humoristic magazines, in comedies etc..

Examples of polysemy and homonymy are common in the authors mentioned above. Here are some of them:

<sup>1</sup> Memushaj, R.( 2006), Hyrje në Gjuhësi, TOENA, pg. 167

<sup>2</sup> Rrokaj, Sh. ( 2005), Hyrje në Gjuhësine e Përgjithshme, Shtëpia e Librit Universitar, Tiranë, pg. 34



*I. The play of words based in polysemy :*

Now, sir, young Fortinbras,  
Of **unimproved mettle** hot and full,  
(Hamlet, Act I, Scene I, pg.10)

Inside these rows we have two polysemantic words that make us understand two different things. When he talks about Fortinbras, his name has the meaning – strong in arms – “i forte në krahë ose armë”, the description must be interpreted in two ways : he has a unimproved, temper and spirit, the words are use in their relevant meaning.. *mettle* – “shpirt, temperament kurajoz” and *unimproved* – “i,e padisplinar”. But another meaning must be that of the type of the material *metal* that is another explanation for the word *mettle*, which is “i paprovuar” – *undisciplined*.

*II. Words-play based in homonymy*

Mother, good night. Indeed this counsellor  
Is now most still, most secret and most **grave**,  
Who was in life a foolish prating knave.  
(Hamlet, Act III, Scene IV, pg. 126)

Through the homonymy *grave*<sup>1</sup> – “a var” and *grave*<sup>2</sup> – “njeri i rëndë, serioz”. Shakespeare reaches to adjust both meaning in the same context in the best way possible. After Polonius dead both lexical units with their meanings adjust to context.

Polysemy and homonymy may be seen in artistic and figurative forms of the word which is a way used in Albanian literature and humour programmes. The word play is created in an artificial way for quirks like *qe si qe, u bë si ka* etc... As a result , artistic humour forms are present in Albanian spectacle “Portokalli” as below :

F2: Gërthisni, mer gërthisni

Të gjithë: E di Rama, E di Ra ma!

F 5: Po, po, ky e di.E di mire ky.

( Portokalli : Skaleta 9.13, 2010-2011)

Zëri: ....Një **ogur**(*prodigy*) i zi ra nga qielli ( a huge stone falls)

Jo **gur**( *stone*) idiot! O gur ! ( another stone falls)

Not only homonymy but also polysemy are used to build the unexpected, abrupt solution, needed for the humour. Here is an example of popular creativity:

I thashë njërit:

- Kur erdhe ?
- Nesor dy ditë.
- Po nga je ti ?

- Nga shtëpia ime.
- Ku e ke shtëpinë ?
- Në mes të oborrit dhe me derë nga lesa.
- Opo, qënke *i trashë* ti!
- Ohu, të shikosh vëllanë tim ti : ta cash, bëhen tre sa unë!

It is clearly seen that the epithet or the adjective *i trashë* ( nga mendja – silly) here it is used in a figurative meaning, as a polysemy used from the prior meaning *i bëshëm*, *i shëndoshë* (fat in your body).

### Conclusion

In the end we must say that polysemy and homonymy remain lexical issues closely related with every aspect of the use of vocabulary within a language. In an intentional manner or not, they are widely used not only as linguistic features but as stylistic features, too. Difficulties that come while they are used, are the same both in English and Albanian language. Anyway, they take a special significance when talking about teaching or learning a foreign language. Analysing in details the origin and the way they 'meet' together in both languages, gives us some valuable insights in terms of this - so much debated distinction.

### References

- Caroll, L " Alice's Adventure in Wonderland", <http://www.gutenberg.org/files/11/11-pdf.pdf>
- Jackson, H. And Amvela, Z.E. ( 2007), Words, Meanings and Vocabulary, An Introduction to Modern Lexicology, 2<sup>nd</sup> Edition, Athenaeum, London, pg. 62
- Loshi, Xh. (2001), Stilistika E gjuhës Shqipe dhe Pragmatika, SHBLU, Tiranë, pg.. 130
- Memushaj, R.(2006), Hyrje në Gjuhësi, TOENA, pg. 115
- Memushaj, R. ( 2006), Hyrje në Gjuhësi, TOENA, pg. 167
- Rrokaj, Sh. ( 2005), Hyrje në Gjuhësinë e Përgjithshme, Shtëpia e Librit Universitar, Tiranë, pg. 34
- Shakespeare , W. (1599), Hamlet , <http://www.feedbooks.com>
- Welman,S. (1962),Semantics : An Introduction to science of meaning, Barnes &Nobles, pg. 156

## Qenia Kombëtare e Shqiptarëve e Përthyer Përmes, Përtej dhe Përkundër Mitit

**Dr. Ismail Stafa**

Universiteti "A.Xhuvani" Elbasan

**Bedri Kaza**

PhD Cand. , Universiteti i Tiranës

-Mbi dramat e Rexhep Qosja-s

Studiues dhe shkrimtar i dimensionit të madh, Rexhep Qosja edhe në dramaturgji ka bërë objekt të kredos dhe shqetësimeve të tij njeriun shqiptar dhe mitin që e ka mbështjellë nëpër kohë, duke u përpjekur të shohë përtej vetëdijeve që e kanë lindur atë. Jo më kot ai e ka titulluar librin e tij me drama "Mite të zhveshura" pikërisht për të depërtuar në indin e gjallë të atij realiteti të largët historik ,që vetëdija mitike mëpastaj e ka transfiguruar dhe e ka kthyer në një mit të mirëfilltë. Ky ka qenë qëllimii vërtetëi shkrimtarit në dramat "Beselem, pse më flijojnë", "Sfinga e gjallë" dhe "Vdekja e mbretëreshës". Veçse kjo është bërë duke theksuar ide të rëndësishme ,që konvergojnë me kohën dhe ndërjegjen e saj shoqërore. Miti shërben vetëm si një mbulesë dhe si një ngacimim paraprak për të pohuar gjësente të tjera, që tashmë ose janë jashtë saj çka kumtohet aty ,ose në kundërshtim me të,ose si mënyrëironie për të stigmatizuar një vetëdije tashmë të prapambetur, të kapërcyer, mbushur me iluzione, por që ende kërkon akses tek mënyra e të menduarit të sotëm të njerëzve.

Sikundër bën me dije Bajram Krasniqi në parathënien që përcjell librin "Mite të zhveshura" ,R.Qosja është nga dramaturgët e parë shqiptarë qëi dha përmbajtjes së ardhur nga mitet frymën e kohës dhe të njeriut të sotëm, duke na e paraqitur të shkuarën dhe korpin etnopsikologjik shqiptar nën dritën e bashkëkohësisë. Si dramaturg ,ai ka mundur të shkrijë në një sintezë të vetme të shkuarën dhe tradicionale me modernen dhe vështrimet tek e ardhmja. Nga ana tjetër, këto tri drama të R. Qosjes përfaqësojnë avantgardën reale të dramaturgjisë shqipe në kuptimin e aplikimit të një mendësie dhe koncepti të ri për shfrytëzimin e rrëfimeve dhe parabolave mitike, në kuptimin e kontensimit të kllisheve ,skemave dhe konvencioneve të ngrira të dramaturgjisë së realizmit socialist në përgjithësi, në kuptimin e një gjuhe të re që kërkonte dhe gjente forma artistike dramaturgjike të fundme ,duke futur në përmbajtjen e herëshme të miteve qasja filozofike, etike, estetike dhe artistike modern. Synimii tij ka qenë ,para dhe mbi të gjitha ,çlirimi nga vetëdijet e prapambetura ,trajtat e ngurtëzuara ,obskurantizmi, ekzotizmi dhe anakronizimii tejkaluar e dëmprurës për progresin social dhe shpirtëror të kombit shqiptar.<sup>1</sup>

Në dramat e R. Qosjes nuk ka vlerë "citimi" apo "ringritja nga varri" e një dëçkaje të "vdekur" ,por marrja e saj si suport për të pohuar ide të tjera, për të krijuar emocione të tjera ,cilësisht të reja dhe me efekte qëi gjegjen situatave ku jeton njeriu i kohës. Pra ,drejtimi përkrah mitit nuk ka qëllim zbulimin e "fosileve" të mënyrës së të menduarit dhe të ndjerit të shoqërive të hershme shqiptare ,as thjesht një "respekt" dhe "përhirim" prej dramaturgu studiues dhe historian ndaj tragjediëve dhe "frymës" së formacioneve shoqërore të mbyllura. Përkundrazi, qëllimii duket fare hapur që ,nëpërmjet lëndës mitike tashmë të "kalcifikuar" në vetëdijen artistike të popullit të mbërrihet natyrshëm në demitizimin e saj ,për të zbuluar se çfarë pikërisht fshihet pas timit, nebulozës dhe mekanizmit fetishizues gjatë përlindjes dhe funksionimi të një miti. Gjithsesi, këto tri kahje që ne përmendëm pak më sipër, lidhen më fort me anën pohuese të ideve, me atë çka shkrimtari rreket të evidentojë e të përcjellë te lexuesii vet. Veç kësaj, sikurse bëhet e qartë pas mbarimit të leximit të dramave dhe kur nis analiza formale ,miti ose pjesë të lëndës mitike të shfrytëzuara kanë shërbyer mirëfilli po aq si metafora letrare dramaturgjike, domethënia e të cilave është kushtëzuar nga qëndrimi ideoestetik i autorit kundrejt materies që ai ka bërë objekt pasqyrimi, reflektimi, sinteze e diskutimi. Sjellja e një kuptimi dhe horizonti të ri ideofilozofik në mitologemat shqiptare që janë përdorur nga R. Qosja, flet për aftësinë e rizgjimeve artistike e lëndës mitike, për energjinë shpirtërore (që është ndryrë në mit), e cila çlirohet furishëm si dhe për sintezat humane ,sociale e nacionale që ky mit ka realizuar falë

<sup>1</sup> Shiko: Bajram Krasniqi, Prathnie nw librin "Mite tw zhveshura", Semantika e miteve, Rilindja, Prishtinw, 1978, f.7-9

përpunimeve që ka pësuar nëpër shekuj. Ndërkaq, lexuesi pikas qëllimet e qarta të autorit për riintegrimin e brendisë dhe ideve që rrethqarkullojnë në një mitologemë kombëtare brenda një hapësire të rrokshme sociale e politike të shqiptarëve përgjithësisht dhe të kosovarëve posaçërisht, brenda një qarku të nënkuptuar kohor kur dhe janë shkruar dramat "Beselam, pse më flijojnë", "Sfinga e gjallë" dhe "Vdekja e mbretëreshës" (vitet 70). Në mënyrë eksplicite Rexhep Qosja na bën me dije qëllimin e tij madhor për ta zhveshur vetëdijen "nebuloze" e mitologjike nga elementët e tejkaluara dhe mbishtresimet anakronike. Në të njëjtën kohë, bistoria e tij në operimet e kujdesshme që ka bërë mbi trupin e mitit, ka hequr indet e kalbura, të vdekura, që me zor funksionojnë në një perceptim modern bashkëkohor, duke ruajtur indet jetike e gjenetike të tij, të cilat janë pjesë e filozofisë që ngujohet aty, pjesë e sintezave jetësore bërë nëpër kohë të ndryshme dhe akumulimit të energjisë psikike me një forcë të tillë shprese sa që rrallë haset gjetiu. Të gjitha këto së bashku bëhen premise për rritjen në mënyrë të dukshme si të madhështisë sublimitet të dramave, si të ekspesivitetit artistik të tyre, ashtu dhe të forcës emocionale dhe impaktit që ato krijojnë me lexuesin.

### Vdekja e një mbretëreshë

Është një monodramë që sjell në vëmendje një periudhë historike të moçme të mbretërisë ilire, ku përpos fuqisë, lavdisë dhe famës që ajo mbërriti dëshmoi edhe dobësi të dukshme në mënyrë të mënyrës së funksionimit në raportin midis popullit, parisë dhe udhëheqësit. Drama e personazhit, Teutës, vendoset në një situatë traumatike, fill pas rrëzimit të saj nga pushteti dhe hegjemonia që mbretëria pati mbi ujërat e detit Adriatik. Koha e ngjarjes është pikërisht momenti i burgosjes së saj, e mundur nga ushtria romake, duke u përthyer në një varg asosacionesh e ndërthesh shpirtërore, të cilat komentojnë, në formën e një ankthi e përjetimi gati halucinant, gjithë historinë e mbretërisë ilire të periudhës së Teutës. "Mbas urdhrave, britmave, gazit të pandërprerë, heshtje në të gjitha anët. Mund të dëgjojë, së paku, një herë vetveten. E mund të dëgjoni edhe ju qëç' keni dëgjuar prej meje. Mos u cuditni! Gjatë këtyre vjetëve që aq të shkurtër ishin, kurdo kam folur, fjalët e mia kanë zhënuar në zemrat e tyra. E, tani, nuk di a do të mbërrijnë as në veshët e perëndisë. Si është e mundur kështu?"<sup>1</sup>

Këto janë fjalët e para që shqipton Teuta. Pyetja e bërë, e cila ndërthet një gjendje të dyzuar, mbushur plot pezm, dyshime, dëshpërim e zemërim, ngjajnë si një prolog hyrës për temën e trajtuar: a.) braktisjen e prijësit të përmbysur, të mundur dhe b.) shkakun e kësaj braktisjeje. R. Qosja nuk ka patur si qëllim shenjtërimin dhe madhërimin e figurës së Teutës, sidoqë në vetëdijen kombëtare ajo është legjendarizuar si një grua-mbretëreshë me gjithë cilësitë dhe tiparet më sublime: trimëreshë, krenare, heroinë, grua besnike e që dashuron plot passion, me cilësi drejtuese e komanduese. Përkundrazi, autori bën që me tejqyrën e tij të dallojë dobësi, mangësi e vese, që u bënë shkak për rrënimin e mbretërisë së ilirëve. Kësisoj rrafshet ironike, satirike dhe sensi kritik janë në përputhje me vetë synimin e autorit për zhveshjen e miteve. Për këtë arsye, vështrimi demistifikues e demitizues bëhen kolonat mbajtëse të konceptimit të figurës së Teutës dhe mënyrës së mbretërimit të saj. Elozhet, fryma panegjrike, stili romantik, zmadhimet dhe zbukurimet ia lanë vendin frymës kritike, sarkazmës, qasjeve groteske, stilit të një realizmi të ashpër me tone herë-herë dhe cinike. Rrafshi ekzistencialist i shikimit dhe hetimit të dukurisë që përfaqëson Teuta, ka sjellë domosdoshmërisht një zhbërillim nga përbrenda të situatës së rënduar psikologjike të heroinës, kur ajo përballet me zhvlerësimin, përbuzjen, shkatërrimin dhe prag-vdekjen. Kësisoj, monologu, biseda me veten, janë ashti i shprehësisë së monodramës dhe mjeti për të mundësuar zbërthimin psikologjik të heroinës.

"Rëndom, tekste të këtilla kanë një ngjyrosje psikologjike, -vëren studiuesi Habri Hamiti, - janë drama të personalitetit. Në rrafshin e të folurit artistik, nga monologu kalohet në shkallën e monologut të dialoguar (termi është i Mihail Bahtinit, i gjetur e formuar duke analizuar të folurit në romanet e Dostojevskit). Në këtë mënyrë, nga pushimi i dramës me kundërshtimin e dy botëve të jashtme për njëra-tjetrën, të botëve të ndryshme, krijohet drama e brendshme, një dialog i ri i botëve"<sup>2</sup>. Prandaj, monologu i heroinës për ta shqiptuar veten, duke mbledhur dilemat personale, por edhe duke i harruar nganjëherë ato, -vazhdon më tutje S. Hamiti, -kthehet në fjalim, në ligjëratë."<sup>3</sup>

Autori sjell në sytë e lexuesit jo heroinën e mitizuar, por njeriun thuasht të rëndomtë, të disekuilibruar. Kjo lëkundje balance nga miti të zhvlerësimi qëllimë dhe kritika ka sjellë për pasojë një vështrim në thellësi të arsyeve pse humbi Teuta me

<sup>1</sup> Qosja, Rexhep. "Mite të zhveshura", Rilindja, Prishtinë, "Vdekja e një mbretëreshë", 1987

<sup>2</sup> Hamiti, Sabri. "Letërsia bashkëkohore", Vepra letrare 9, F. Konica, Prishtinë 2002, f. 124

<sup>3</sup> Po aty, f. 125

ushtrinë romake,cilat qenë shkaqet dhe ligjshmëritë e rënies së mbretërisë ilire.Veç demitizimit të saj si *prijëse* dhe *mbretëreshë*,në vepër vepron edhe kahja e demitizimit si *njeri* dhe *grua*.

"*Qe,hajdeni,jam gati,-thotë ajo kur romakët e burgosin në një izolim të plotë,-merreni bazilleshën.Mos të jetë bazilleshë.Le të jetë grua.Vetëm grua...Unë të vdes e ata të jetojnë!Kurrë!Kurrë...Kurrë....Vetëm grua...vetëm grua...*"<sup>1</sup>

Pra,në këtë mënyrë zhvishet miti i mbretëreshës krenare,i heroinës,dhe përballë lexuesi ka një grua fatkeqe ,thuaje historike,tejet e pikëlluar dhe pa dinjitetin lartësues të prijëses.Kahja demitizuese vepron duke aplikuar konceptin ekzistencialist për jetën si një fatkeqësi,po edhe të vdekjes si një pamundësi për t'i bërë ballë asaj mesteoicizëm.Kështu vepra procedon drejt problemit kryesor,duke kërkuar shkaku e rënies së udhëheqësit si pasojë e humbjes së lidhjes me popullin e vet.

Ruga që ndiqet për realizimin e procesit demitizues të Teutës si mbretëreshëështë ajo e rëfimit në vetë të parë të udhës së rënies së saj politike,morale dhe shpirtërore;është një send i fortë autokritike,që shoqërohet jo rrallë edhe me pendesë,me njohjen e gabimit sikurse është, po ashtu ,edhe sensii shpotisë,iironisë dhe i cinizmit për të rivlerësuar ,nga pikëpamja ekzistencialiste,natyren e njeriut dhe tjetërsimin që atë e shoqëron.

"*Të përulem ,kur je me roje mbas,-shfryn dufin Teuta në vetminë e saj,kur ka rënë nga pushteti dhe vuan shpërfilljen,zhëgënjimin e thellë,-të puthin duart kur je në fron,të bekojnë kur të përcjellin e të urojnë kur të kthehesh;kur fillon fronti të luhatet,të gjithë e mohojnë se të kanë puthur duart,se të janë përlur.*"<sup>2</sup>

Ndërkaq ,veç kësaj kahjeje ,monodrama ka edhe një vështrim sarkastik në kahun tjetër,pra në mënyrën se si e shikojnë të tjerët Teutën:jo si një mbretëreshë e pushtetshme dhe si prijëse, por më së pari si vallëtare,si grua të bukur dhe kryeneçe.Njerëzit shquajnë dhe vlerësojnë tek ajo jo aq mençurinë sesa bukurinë.Bukurinë e lakmojnë ,pushtetit i shmangen.Në këtë pikëpamje marrëdhënien e saj me botën nuk e krijon individi por të tjerët (pra bota).Rrëzimii mbretërisë ilire dhe vetë mbretëreshës ka ardhur edhe nga vetë mënyra e vlerësimit të të vetëve,të cilët çmonin tek Teuta thjesht bukurinë femërore dhe jo dinjitetin,mençurinë,personalitetin."*Nuk mund të jeshë bazil i vetëvetes,-shfryn ajo,-mund të jeshë bazil i të tjerëve.*"

"*Gruaja në fron është rast,-shprehet më tutje,-por rast që e ka bërë të mundshëm origjina dhe bukuria e saj.*"<sup>3</sup>

Deliri i madhësisë,prepotenca,veprimet irracionale të Teutës gjatë mbretërimit bëhen objekt kritike e mohimi nga vetë heroína në castet e burgosjes dhe në prag-vdekjeje.Kështu,ajo anatemon veten si grua fatkeqe,e braktisur,e vetmuar,e mbyllur në një kullë,e izoluar,duke rënkuar e duke u ankuar për fatin e vet.Sigurisht,një gjetje e tillë bëhet për t'ia hequr nga koka aureolën e prijëses plot dinjitet e trimëri të pashoqe,sikundër është latuar figura e saj në përfytyrimin popullor,pra në qasjen mitologjizuese.Duke qarë e duke sharë fatin dhe rrëzimin e vet nga mbretërimi dhe pushteti,tërthorazi autori na jep edhe rrethanën historike ku veprimi kjo mbretëreshë,qarkun e veseve dhe egoizmin e shfrenuar të oborrtarëve,përçarjet,frymën pirateske dhe mungesën e aftësisë për të ndërtuar një shtet të bazuar mbi arsyt dhe ligjet e forta,bjerrjen morale dhe dëshpërimin kolektiv etj.-rrethanë kjo determinuese e shkatërrimit të mbretërisë ilire.Ajo e kishte fort të vështirë në mesin e cubave,hajnave,vrasësve,ku zor të dalloje shqiponjën prej korbit.Tjetër ide e mprehtë që vjen nga vështrimi demitizues i R.Qosjes ndaj figurës së mbretëreshës Teutë dhe mbretërimit të saj është raporti midis bukurisë,mençurisë dhe pushtetit.Forca kërkohet si mundësi dhune për të luftuar po dhunën që sundon,për të vendosur rregull,ligj,hierarki.Andaj,në dëshpërim e sipër,ajo këlthet:"*Kush do ta sjellë në vete këtë kope?Kërbaci,të cilin nuk kam ditur ta përdor*".Por ajo është pjesë e popullit të vet,i cili rëndon "e vë krenarinë mbi lumturinë".Përmes një kontrapunkti,në krahasim me ushtarët romakë,Teuta e vlerëson popullin e vet idhtaz:

"*Ata janë të bashkuar,prandaj i kanë ashtu rradhët të shtrënguara.Nuk zihen rreth packës;rreth arave dhe sinoreve;rreth grurit dhe drurit;rreth grave dhe vashave;ata nuk ia presin dorën njëri-tjetrit që t'ia puthin të huajit.Secili e di punën e vet:patrici dhe plebeji,bazilii dhe sklavi.I ka mbushur korbaci mendtë.Tani duan të na mësojnë edhe ne?"<sup>4</sup>*

<sup>1</sup> Rexhep Qosja,"Mite të zhveshura",Rilindja,Prishtine 1978;"Vdekja e nje mbretereshe",f.324

<sup>2</sup> Rexhep Qosja,"Mite të zhveshura",Rilindja,Prishtine 1978;"Vdekja e nje mbretereshe",f.324

<sup>3</sup> Rexhep Qosja,"Mite të zhveshura",Rilindja,Prishtine 1978;"Vdekja e nje mbretwreshe",f.326

<sup>4</sup> Rexhep Qosja,"Mite të zhveshura",Rilindja,Prishtine 1978;"Vdekja e nje mbretwreshe",f.321

Autori e vendos Teutën në një vijë ndarëse:nga njëra anë madhështia e saj,nga ana tjetër rrëzimi dhe poshtërimi;nga njëra anë mendimi autoreferencial se ajo na ishte një mbretëreshë e lavdishme,nga ana tjetër dizintegrimi i personalitetit me pamjen e një mediokriteti zhvlerësues,dukuri e cila nuk mbetet vetëm te bukuria dhe dobësitë e saj si femër e përkëdhelur.Autopsikobiografia e Teutës si grua e bukur,krenare ,e mençur e kokëfortë janë më shumëtribute që ajo ia përkushton vetëvetes sesa të tjerët asaj.Madje,ajo mbërrin gjer në ditirambe mitike,me një lloj automatizmi si zanë e malit,nimfë e detit etj.Ky konflikt i brendshëm qasjesh,që ravijëzohet gjërazi midis madhësisë së saj si mbretëreshë dhe mediokritetit të një gruaje të rëndomtë plot dilemma,i shkakton vuajtje,dyshime ,dizintegrim,dhe prandaj tri here i afrohet vetëvrasjes,pa mundur ta kryej dot këtë akt pikërisht ,për mungesë vullneti e madhësitie.Dhe në castet e katarsës klith: " Oh,e mjera unë,as bazilleshë ,as nënë,asgjë!Askush!"

Nga një optikë e tillë konceptimi,R.Qosja bën një prerje të filozofisë pozitivistive,e cila e sheh dhe e koncepton veprimin historik si një raport dialektik e fort të ngushtë midis faktorit social politik që dominon një dukuri a periudhë të caktuar,dhe faktorit të vullnetit personal,që ndikon fuqishëm në këtë veprim historik.Kështu ,dështimin e Teutës autori nuk e sheh vetëm si pasojë e teprimeve të pushtetit të saj apo e mangësisë së forcës së karakterit e moralitetit.Ai e sheh atë po aq (sidomos) në tendencat përçarëse të parisë që udhëhiqte vendin,në cmirën dhe zilinë për pushtet,në mungesën e menaxhimit energjisë shpirtërore të popullit,në mungesën e koherencës e logjikës të vlerësimit të gjësendeve.E gjitha kjo na shpërfaqet përmes rrëfimeve të Teutës,herë me tone të ashpra të një kritike të rreptë,dhe herënë tone ankuese,të një femre qeramane e qyqare,pa personalitet e dinjitet prej mbretëreshë.

*"Rexhep Qosja në dramaturgjinë tonë,-vë në dukje studiuesi NebiIslami,-I pari nga këndvështrimi filozofisë së pozitizmit logjik,ngre çështjen e rolit të personit në histori dhe dilemën se a është ai produkt i rrethanave,a mund ta krijojë epokën dhe çfarë është ndikimi tij ,apo personi mund të jetë produkt i rastësisë historike,ndërsa përmes demitizimit të Teutës ,të shprehur në formë të identifikimit me pasionin,narciozimin dhe luhatjen,personazhin e saj e nxjerr si produkt të rastësisë."*<sup>1</sup>

Miti pushtetit,si përbajtja themelore e ideve dhe emocioneve që përfaqësohen përmes përjetimeve të Teutës,na vjen kryesisht falë dy rrugëve:1)vështrimit të figurës së prijësës,udhëheqëses,mbretëreshës nga një optri humaniste,një njeri mes hallesh,ankimesh,çfilitjes shpirtërore dhe 2)vështrimit të figurës së mbretëreshës-njeri nga një optri ekzistencialiste,ku universaliteti gjendjes shpirtërore të qenies njerëzore shfaqet si premisë e pasqyrimit artistik,si mënyrë sintetizimi,përfshirë gjithë problematikën që e shoqëron nëpër rrjedhën e ndërkohës: lindje-vdekje.

Sigurisht,kahja demitizuese e qyerjes së mbretëreshës Teuta dhe mbretërimit të saj nuk shkon deri në denigrim.Ajo ruan,megjithatë ,sënsin e ekuilibrit në vlerësim.Andaj, shpesh,nga goja e heroinës dalin edhe mendime e opinione,të shprehura përmes mllëfit,të cilat ,përvenc ngjyresës filozofike ,kanë edhe pjesë të së vërtetës sonë kombëtare: "Keni kaluar shtrëngatat,detërat dhe shkëmbinjtë që t'i pushtoni tokat e mia.Mendon se këtu do të gjeni qetësinë?Keni harruar se qetësia juaj do të mvaret prej nesh,ashtu sic mvaret gjithmonë paqja e pushtuesit prej durimit të të pushtuarit.Jo.Nuk na njihni mirë.Ju keni marrë guxim prej fatkeqësisë sime dhe prej urrejtjes suaj.Guximi juaj do të jetë edhe fatkeqësia juaj."<sup>2</sup>

Dhe fill më pas,Teuta vijon në kahjen sarkastike ndaj po atij populli e atyre njerëzve që pat lëvduar,ndën një dëshpërim të thellë:

*"Të gjithë janë dorëzuar.Tani edha ata më lenë.Edhe Fariëshhtë bërë me ta.Kam mbetur vetëm..."*<sup>3</sup>

Tema universale e pushtetit,raporti i prijësit me popullin,vështrimi në thellësitë e njeriut të shpronësuar e në prag vdekjeje,ku shanset pakësohen e qiejt mbyllen,duke sjellë vështrime jo thjesht sarkastike pesimiste,por edhe një vetëdije të kthjellët kritike ,duket se krijon integralen e mendimit demitizues të monodramës " Vdekja e një mbretëreshë".

*"Riaktualizimi temave të mocme,temave të vjetra ,që janë përherë aktuale në jetën njerëzore,-thekson Sabri Hamiti,-riaktualizimi personalitetit të dilemave,i personalitetit të ndarë në dysh,i njeriut që e humb mbretërinë dhe njeriut e prijësit që mundohet të jetojë dy jetë:njërën për veten e nevojat e veta njerëzore e tjetrën për të tjerët,i pafuqishëm ta luajë jo rralë këtë rol me dy fytyra kaq të ndryshme në mesin e shoqërisë dhe në kohë e histori,është njëra nga intencat e para të*

<sup>1</sup> Nebi Islami,"Historia dhe poetika e drames shqiptare", (1886-1996),II,ARTC,Prishtine,2003,f.30

<sup>2</sup> Rexhep Qosja,"Mite të zhveshura", Rilindja,Prishtine 1978;"Vdekja e një mbretëreshë".f.321-323

<sup>3</sup> Rexhep Qosja,"Mite të zhveshura", Rilindja,Prishtine 1978;"Vdekja e një mbretëreshë".f.323

veprës. E njeriu që nuk mund t'i jetojë dy jetë të ndryshme, nuk e jeton asnjërën dhe shndërrohet në një tip tragjik. Në këtë pikë, tekstii monodramës *Vdekja e një mbretëreshe* është një tekst parabolë mbi të sotmen. Mu këtu qëndron vlera më e madhe e tij. Të aktualizohen sërish të theksohen problemet, që në shoqërinë njerëzore të kohëve të ndryshme përsëriten. Kemi të bëjmë me të keqen e të ligën që përsëriten. Apo jetojnë të gjalla jetën e tyre mijëravjecare, përherë të njëjtit po me një qëllim, edhe pse në këtë të ndryshme e në shoqëri të ndryshme mund të dalin me fytyrë të re, të ndryshuar me dekor të ri".<sup>1</sup>

Prania e drejtëpërdrejtë e ndikimit të mitit në monodramën "*Vdekja e mbretëreshës*" shfaqet edhe tek bekimet apo mallkimet, që të kujtojnë pikërisht lutjet ndaj *Perëndisë* apo anatemat ngaj *Qoftëlargut* dhe trazimeve të tij. Ja disa syresh:

1. Në formë bekimesh.

"Perëndi! Bën që name i tij të mos shuhet! Bën që name im të ruhet! Kujdesu që të ketë uri dhe etje, që të lulëzojnë pemët dhe të shtohen të korrat, që të pjellin bagëti dhe të shumëzohen bletët, që të kenë gjij nënat dhe të rriten foshnjat. Perëndi! Vetëm Ty të bie në gjunj dhe vetëm Ty të lutem: mallkoje armikun, dënoje tradhtarin. Dhe mos e harro Laidin tim të vogël, të humbur. Perëndi, më jep ndjesën herën e fundit se unë të jap vetën."<sup>2</sup>

2. Në formë mallkimesh.

"Le të ngushtohen rudinat dhe të zgjerohen kënetat; le të tërbohen detërat dhe le të shuhen yjet; le të rrafshohen mallet dhe le të ngrihen fushat; le të digjen lumenjtë dhe le të thahen të mbjellat; le të vdesin njerëzit dhe le të sundojnë shtazët!"<sup>3</sup>

### Baselam, pse më flijojnë

Në dramën *Basem, pse më flijojnë* Rexhep Qosja sjell në dramaturgjinë shqipe mitin ilir të sakrificës, të murimit të njeriut të gjallë, moralisht të pastër, të ri në moshë, për hir të mbrohtësisë së kolektivit, të ardhmërisë dhe qëndrueshmërisë së fisit. Sakrifica sublime bëhet për të shmangur veprimin e forcave djallëzore, furive të së keqes që prish dhe shkatërron jetën, ekzistencën, që dizintegron shpirtin dhe vetë njeriun, që sjell përçarje midis etnisë, që krijon një atmosferë konflikuale. Thelbi i mitit të sakrifikimit të një qenieje njerëzore si thërror e blatim ndaj perëndisë për mbijetesë dhe mbarësi, nuk i qëndron mirëfilli thelbit ontologjik nga ku ka lindur, thelbit religjioz, atij psikik dhe më tutje thelbit filozofik (si mesazh, si porosi etnopsikologjike e ngjirë në një situatë dhe subjekt fantastik).

Sakrifica e Hanës, nuses së re të Beselemit, merr tjetër konotacion duke u shfrytëzuar për të tjera qëllime, jo në voli të shpëtimit, përhirimit të njerëzve dhe *katarsës* kolektive nga mallkimil hershëm, por në voli të të synimeve okulte të pushtetit për të krijuar një masë popullore amorfë, pa personalitet, të njësuar, ku mohohet individualiteti, ndryshimi dhe mëvetësia mendore dhe shpirtërore. Andaj flijimi i Hanës kërkohet si referencë për një flijim pa kushte e në çdo kohë që e kërkon arsyeja shtetërore. Pra një sakrificë kolektive dhe të përherëshme, përputhur interesave të sundimitarit. Filozofinë e njëjtësismit dhe kolektivitetit amorf e shpreh Haruni në fjalimin e tillë të fundit përballë qytetarëve:

*Ushtarë dhe udhëtarë!*

*Do të mësohemi të bëjmë sakrifica,*

*Sakrifica të jashtme*

*Dhe sakrifica të brendshme,*

*Pa kurrëfarë dallimi,*

*Pavarësisht a jemi të pasur,*

*Pavarësisht a jemi të varfër.*

<sup>1</sup> Hamiti, Sabri. "Letërsia bashkekohore", Vepra letrare 9, F. Konica, Prishtinë 2002, f. 129-130

<sup>2</sup> Rexhep Qosja, "Mite të zhveshura", Rilindja, Prishtinë 1978; "Vdekja e një mbretëreshe", f. 322-323

<sup>3</sup> Rexhep Qosja, "Mite të zhveshura", Rilindja, Prishtinë 1978; "Vdekja e një mbretëreshe", f. 223

*Duhet të mendojmë me një kokë,*

*Njëri të mendojë si të gjithë,*

*Të gjithë të mëndojnë si njëri.<sup>1</sup>*

Vepra është e ngarkuar nëide që shestohen në rrafshë ekzistencialiste ,ku sintezat e sprovave historike të jetës ,të gërshetuara me sintezat e ardhura nga perceptimet metafizike të mistereve ,realizohen në linjën e flijimit ,të terrorisë së paraparë,më së shumti në trajtën e traditës ,të trashëgimisë etnopsikologjike dhe të parashkrimit (fatalitetit),rjedhimisht të martirizimeve tragjike.E gjithë kjo lëndë mitike e mistike që trashëgohet në mënyrën e të kuptuarit të qëndresës ndaj faktorëve dizintegruues,nuk ndjek parimin e një mitizimi të dytë ,pra të një rimitizimi ku fantazia dhe elementët artistikë e ritin ndjeshëm forcën sugjestive të subjektit.Përkundrazi,falë kontrapunkteve dhe kundërshtive ,ironisë dhe tjetërsimeve kjo lëndë demitizohet duke synuar profanizimin e saj.Për pasojë ,në dramën e R. Qosjes *Beselem,pse më flijojnë* shikohet më fort konflikti që shkaktohet midis pushtetit dhe popullit,pushtuesit dhe të pushtuarve,prijësit të dhunshëm e të huaj dhe nënshtetasve që kërkojnë më shumë liri,midis masave shtrënguese restriktive dhe dëshirës së njerëzve për më shumë hapësirë jetike.

Duke qenë se drama ka shfrytëzuar gjerazi mitin e murimit ,tepër i përhapur në viset shqiptare, është me interes ta shikojmë këtë mit në pikëtakimin e tij me figurën e "hijes",që gjendet diku në shtëpi,e shfrytëzuar mjaft mirë në dramë.*Hija* është konceptuar në frymën e mitit,si një forcë mistike,ezoterike,e pakapshme,e konceptueshme,e padukshme.Pra,si shpirt i mirë.Një shpirt që struket,hyn brenda në lëndën e ashpër të gurit,bëhet pjesë e familjes,në rastin tonë e komunitetit,e fisit,e popullit;jep besim,siguri;mbrojnë një të ardhme kolektive.Së dyti,ajo na shfaqet si një shpirt i keq,që bredh natën,shajnon,shprish,shqetëson,ngjall dyshime gjithkund e tek gjithkush,shndërrohet në forcë djallëzore.Ja ç'thotë Monuni:

*Nëpër gërmadha ecën një hije e shëmtuar*

*Me bisht të gjatë e brirë të dhisë*

*Nuk do të frikohej as prej syve të mamijës*

*As prej vajit të fëmijës....<sup>2</sup>*

Në të dyja rastet hija ka karakter simbolik dhe alegorik.Ajo përfaqëson njëherazi të mirën dhe të keqen.Të dyja këto attribute që vijnë drejtpërdrejt nga thelbi mitit shqiptar të murimit,janë kapur dukshëm nga shkrimtari për të mbërritur më pas ,në fund të pjesës,në një simbolikë e alegori të pastër letrare dramaturgjike.Gjithnjë në linjën e mitit (vetëdijes mitike),flijimi i një njeriu,pra i një gruaje të porsamartuar dhe me fëmijë në gjë,bëhet bartëse e jetës së mëtejshme,sepse ajo është vetë bartëse e kësaj jete.Ajo sjell mbarësi .Ky besim vjen dhe shprehet në dramë përmes pohimeve,sidomos përjetimit të fisit që kërkon,gjithsesi,një rrugëzgjdhje për të përballuar rroposjet e herepasherëshme.

Shfaqja e nuses së murosur të mitit në muret e kështjellës me foshnjën në gjë dhe vajit saj për të birin,kthehet në shenjë profetike ku lidhet porosia e moçme mitologjike e flijës së gjallë njerëzoreme nevojën për flijim të ri,që mallkimi të mbarojë e të dëbohet nga njerëzia.Prej këtu lind nevoja e flijës së pastër njerëzore me nevojën për flijim të ri,që mallkimi të mbarojë e të dëbohet nga njerëzia.Prej këtu lind nevoja e flijës së pastër njerëzore dhe jo të një gjëli,të një dashi a të një demi,që sipas Molosit:"*I therrim për qejfin tonë,e jo që të mëshirojmë tynzonë* ."Para kësaj shenje ,patën ardhur edhe disa shenja të tjera,në formën e ëndrave,sikundër qenë:elementi ezoterik me tri rathë prej ari me nga një gogël në mes që shfaqen në qiell si dhe shpjegimet që u bënë *Molosi* si mag ;ose shenja të tjera si shtatë lopë të ligura që kanë ngrënë shtatë lopë të majmura,shtatë fije gruri të njomë që janë tharë afër shtatë fijeve të thata.Në këtë mënyrë elementi ezoterik shfrytëzohet nga autori për rritjen e fortë dramatike,për obsesionin kolektiv,për parandjenjat e këqija me krijimin e një gjendjeje telepatike,e cila e bën të domosdoshme sakrificën si mjet shpëtimi .

<sup>1</sup> Rexhep Qosja,"Mite të zhveshura",Rilindja,Prishtine 1978;"Vdekja e nje mbretereshe".f.279

<sup>2</sup> Rexhep Qosja,"Mite të zhveshura",Rilindja,Prishtine 1978;"Vdekja e nje mbretereshe".f.216



Flijimi sjell edhe fatkeqësi. Në dramë flitet për rroposjen e përmatshme të mureve të urës lidhëse midis dy brigjeve prej shpirtërave të këqinj, prej hijeve të zeza. Fatkeqësia ,që është me konotacione materiale, lëndore, merr më pas konotacione shpirtërore. Hana, nusja e sakrifikuar, nuk përfaqëson një fatkeqësi vetëm për veten e saj, as vetëm për burrin e saj. Beselamit, por edhe një fatkeqësi ekzistenciale, në kuptimin e privimit të padrejtë të jetës. Pra, kemi një padrejtësi. Të vëllezërit e Beselamit, Laidi dhe Bidadi, tok me nusët e tyre Fana dhe Etleva, jo vetëm që nuk e pranojnë sakrificën duke e vlerësuar atë si një tmerr dhe humbje shkatërrimtare, por edhe i dredhojnë asaj. Sidoqë e çiltër dhe fort e dashuruar pas Beselamit, Hana bëhet fli jo me dëshirën e saj, por me atë të Beselamit si dhe të vetë komunitetit.

Ajo që na bën të vëmendshëm sa i takon argumentit tonë mbi demitizimin në dramën "*Beselam, pse më flijojnë*" është hetimi dhe shfrytëzimi i mitit në tri rrafshet: a) zbuluesi religjioz ,mistike dhe ezoterike e tij ,duke e kthyer në të kundërtën, pra në demistifikimin e fabulës baladeske me gjithë rrëfenjën "fantaste" të ngritur sërish ,duke i dhënë pra një shpjegim të natyrës së filozofisë pozitiviste; b) shkrija e kufjive të lëndës mitike me lëndën sociale politike të realitetit shqiptar ,duke u rrekur të krijohej sinteza midis të shkuarës së largët me të sotmen e afërt, sinteza të cilat bëjnë shpjegime të tipit ekzistencialist të raporteve midis individit dhe kolektivit, midis shtetit dhe popullit, midis diktaturës dhe lirisë; c) dekompozimi i mitit (duke ruajtur ,gjithsesi, fuqinë intriguese të fabulës), i cili gërshetohet me qasjen dhe poetikën dramaturgjike të simbolizmit dhe ekspresionizmit.

Procese demitizuese në dramën "*Beselam, pse më flijojnë*" shfaqen posaçërisht edhe në disa linja të tjera.

Linja e parë demitizuese është e lidhur me murimin e Hanës dhe kundërshtimin e saj jo thjesht nga frika dhe dashuria për të jetuar, por edhe nga arsyeja dhe kuptimi i absurditetit të një veprimi të tillë, që nuk sjell shpëtimin real nga fatkeqësia.

Linja e dytë demitizuese e dramës vjen nga zgjidhja dhe fundi i saj. Paçka se sakrifika sublime e një jete të pafajshme e të pastër sa ska, siç qe ajo e Hanës, nuk solli ndalimin e katastrofës dhe të rrënimit të mureve. Dështimi i një sakrifice, pra edhe një mendësie të vjetër e tradicionale që ushqehet apo sintetizohet në mit, duket se pasohet nga një dështim i ri, pasi njerëzit mbeten sërish në terr, në paqartësinë e qëllimeve, e udhës për të ndjekur të nesërmen.

*"Do të bëjmë sic na thuhet, prej qytetit s' do dalim, as do të lejojmë të na vijë kush, le të na rrojë Haruni ynë, Amen!"*<sup>1</sup>- përgjigjen në kor turma e qytetarëve ,duke lënë të kuptuar se gjithcka ka qenë e kotë, po njësoj :se errësimi i vetëdijes nga pushteti dhe mjetet e mashtrimit dhe iluzioneve vazhdon të mbetet po ai.

Linja e tretë demitizuese është ajo e revoltës së Beselamit gjatë dhe pas sakrifikut të gruas së tij, Hanës. Ai ka guximin ta shohë këtë akt jo si një therrori sakrale, pra me bindje të plotë dhe devocion ndaj perëndive (si dikur në mit). Ai e sheh atë më shumë si një nevojë e detyrim që vjen prej vetëdijes morale të komunitetit ku jeton dhe prej të cilit ka trashëguar edhe bestytnitë ,paragjykimet dhe obskurantizmin e kësaj vetëdijeje.

Linja e katërt e demitizimit procedon si "*alter*" domethënë jo si ajo që pohohet drejtpërdrejt në rrjedhën e ngjarjeve në dramë, por si ajo që vjen tërthorazi nëpërmjet nënkuptimit nga ana e autorit, thënë ndryshe nga qëndrimi ideomocional i tij. Kështu, sidoqë masa njerëzore lihet në kaosin e vet, ende e paqartë, nga ana tjetër, lexuesi dhe shikuesi tashmë e ka marrë mesazhin e autorit, ka kuptuar fatalitetin dhe absurditetin e gjendjes dhe përsëritjes së saj në një cikël vicioz.

Linja e pestë lidhet me shfrytëzimin e ritualit si mënyrë e dëshimit të një lënde etnopsikologjike mirëfilli shqiptare, përfshirë pra edhe mitologjinë. "*Një segment i rëndësishëm që si risi i bashkëngjitet dramës së rimitizimeve në tragjedinë "Beselam, pse më flijojnë", -vë në dukje N. Islami, -është rikuptimësimi i ritualit, të cilin autori e inkorporon në formë të lutjeve për lindjen e diellit, për ngrohjen e dheut, për zgjimin e natyrës, për shtimin e foshnjeve, për rritjen e krahut të punës për të ngdhnjyer mbi të zezat si formë e gjallë e vetëdijes, në mënyrën e shprehjes së dobësisë kolektive dhe të paafësisë për zëvendësimin e dëshirave me aksionin për sendërtimin e synimeve jetike dhe të gjakimeve të castit"*<sup>2</sup>

Linja e gjashtë është ajo e konfigurimit të një ardhmërie, që duhet të përfshijë veprimin e pritsëm të bashkësisë, i cili nënkupton një progres të nevojshëm social dhe nacional. Paradigma psikike e Beselamit dhe vetë ai si arketip shqiptar, nuk vjen e as shprehet më si bartësi i herëshëm e tradicional i kumtit mitologjik. Përkundrazi, R. Qosja e ka shndërruar atë në bartësin e një kumti filozofik që lidhet dhe buron nga koha ,modern, rrjedhimisht nga vetë autori....

<sup>1</sup> Rexhep Qosja, "Mite të zhveshura", Rilindja, Prishtinë 1978; "Vdekja e një mbretëreshe", f.248

<sup>2</sup> Rexhep Qosja, "Mite të zhveshura", Rilindja, Prishtinë 1978; "Vdekja e një mbretëreshe", f.254

## Sfinga e gjallë

Është drama ku R.Qosja rreket të përcjellë idenë e kudogjendur mes shqiptarëve:hakmarrjen.Po në kuptimin e shfrytëzimit të materies mitologjike (nënkupto:biblike),në dramën “*Sfinga e gjallë*” autori ka cekur dhe respektuar gjithashtu metaforën e veprimit rrënimtar të hakmarrjes që s’njeh arsye ,pajtim,falje,vecse mëri,zili,xhelozia.Kështu,anatomia që bën shkrimtari mbi korpin biblik të marrëdhënies mes vëllezërve (Habili dhe Kabili),prek sintezën që vjen prej andej:anatemën e përjetshme dhe mallkimin ndaj vëllavrasjes,si krimi më i rëndë e më shkatërrimtar,të cilin hyjnia e ndëshkon me masën më të rreptë.

E kundruar në aspektin e mitizmit,doemos në këtë dramë mirëfilli na është dhënë paradigma e krimit dhe e dhunimit qysh nga fillesat biblike.Andaj,jo thjesht personazhet dhe emrat e tyre,por edhe misteri i raportit vëllavrasës Kain-Abel me shpjegimin gjegjës përkrah parabolës biblike,janë të pranishëm në lëndën letrare të dramës,më së shumti si nënkuptime dhe bashkëshoqërime ideoemocionale.Shfrytëzimit lëndës mitike (në këtë rast i Biblës) prek esencën e motivit të raportit Abel-Kain,fuqinë destruktive të krimit që vjen si pasojë e urrejtjes dhe sjelljeve irracionale,ku harmonia dhe mirëkuptimi priset nga fuqia shkatërruese e kësaj urrejtjeje dhe kësaj sjelljeje irracionale.

E keqja dhe kriminalja ,që përfaqësohet nga Kabili,nuk është vetëm një premisë mbi dëshminë e ricikluar të krimit si të tillë por edhe një premisë e shkatërrimit dhe vuajtjeve të të gjithë përsonezave,që janë të lidhur dashje pa dashje me kriminelin dhe krimin,përgjithësisht me dhunën dhe të keqen.Pasojat e kësaj dhune dhe të vetë të ligës janë përfaqësuar,në një masë jo të pakët dhe me një gjuhë ekspresive,nëpërmjet personazhit të *Mukailit*,në rolin e një loloje,me shkrimet e tij delirante ,të tmerruara nga llahtara.Në të njëjtën kohë,e keqja dhe kriminalja rreket të nguliten në vetëdijen e djelmohave të rinj që sapo u ka dirsur qimja në faqe si Lami e që duhet doemos të “*burrërohen*” duke vrarë dikë nga vrasësit e dikurshëm të fisit të vet.Gjaku i gjyshërve,i stërgjyshërve e i katragjyshërve kërkon patjetër shpagë, sidoqë i vrari i mundshëm është një pafajshëm.Përshkrimi i trazimit shpirtëror të Lamit para një vrasjeje “tradicionale” që bënte pjesë në ritualin e gjakmarrjes,krahaz pendesës,jep edhe “dramën” e njeriut që vret dhe të atij që vritet.

Nëse e marrim këtë episod dhe gjithë dramën në tërësi,tashmë në aspektin e demitizimit ,është krejt e qartë se “*Sfinga e gjallë*” anon pikërisht drejt kësaj kahjeje.Në një rrafsh përgjithësues,në qasjen tonë analitike lidhur me argumentin që kemi pëlqyer për të shqyrtuar,pak a shumë mund të veconim disa elemente,kahje a mënyra të implementimit të asaj që e kemi quajtur demitizim.

Demitizimi i raportit vëllavrasës Habil-Kabil shfaqet edhe në një aspekt të mirëfilltë social dhe politik.Ndonëse drama ka mjaft konotacione filozofike të ekzistencializmit ,për lexuesin bëhen të qarta ravijëzimet që autori ka hequr nga njëinterpretim si të thuasht,i filozofisë pozitiviste.Kështu “*ontologjia*” e krimit shihet si një konflikt shoqëror,që nëpër histori ka shkakuar luftëra dhe rroposje të mëdha,të shoqëruara me ploja të papara dhe masakra që ripojnë në thelb paradigmen e lashtë biblike të Kainit.Nëpër të tilla luftra në kasaphana njerëzore,ngaherëështë shfaqur përpara njerëzimi vetimii metaforës biblike të vëllavrasjes si errësim i vetëdijes,si teprija dhe zotërimi i veprimeve irracionale kur e drejta nuk gjen vend nëpërmjet arsyes;po kështu,ky raport shpreh edhe gjithë zinxhirin e fatkeqësive sociale dhe politike,të shprehura në regjimet e dhunës,në shtetet diktatoriale dhe shoqëritë totalitare.

Më në fund ,personalizimi i figurës së Habilit,ku larg e larg shquhet *siluteti* intelektual i R.Qosjes në raport me të tjerët (posacërisht me intelektualë delirantë e mendjemdhejtë të qarqeve kryesisht joshqiptare),mbetet edhe kjo një kahje e hamendësuar e procesit demitizues,ku tashmë raportii moçëm dhe universal i metaforës së krim-ndëshkimit njëmendësohet dhe parashihet edhe si një strukturë e brendshme shpirtërore që buron,sikurse ngjet si rregull në letërsi,edhe nga mbresat,idetë,përjetimet dhe përvojat personale të shkrimtarëve,gjithsaherë në të shihen vëllazërime idesh të mundshme.Po sjellim veçse një mendim e qëndrim të njohur (të autorit),i shprehur edhe në vepra të tjera të tij,lidhur me Besën dhe Pabesinë (asosacione të krimit dhe ndëshkimit),duke u dhënë atyre konotacionin e kohës së fundme ndër shqiptarët.

Drama “*Sfinga e gjallë*” është ,në një kuptim ,kirurgjia e krimit dhe e vëllavrasjes.Lajthitjet shoqërore në rrjedhat e historisë,urrejtja ,armiçësitë,egërsia,mungesa e arsyes dhe zotërimi i pasioneve shkatërruese e bëjnë njeriun dhe vetë shoqërinë në kohë të caktuara që të zërë udhë pa krye e të shkojë drejt shkatërrimit dhe vetëshkatërrimit.Një psikikë e tronditur dhe e rrënjosur në trashëgimitë negative bëhet premisë për krimin,si atë individual ashtu edhe atë kolektiv.Kjo është një e vërtetë universale,e pohuar me elegancë dhe përjetim të thellë nga ana e autorit në dramën gjegjëse.Drama “*Sfinga e gjallë*” përcjell një apel human,që kërkon pastrimin e vetëdijëve të errësuar nga epshi i gjakut dhe krimit,që

---

kërkon arësye ,kthelltësi dhe sycelje,që kërkon sidomos një proces të parreshtur emancipues,qytetërues,për të mbajtur ngaherë lart të pastër e madhështor,fisnik e hyjnor,tempullin më tëçmuar të krijimit,të jetës dhe të vetë rruzullit:Njeriun.

---

## How Long Will Global Economic Crisis Last?

**Sabri Gashi**

*Master of Science of Security, European University of Tirana,*

Faculty of Law, Management in Public Right

*sabri.gashi1@gmail.com*

*Phone: 044-277-005, Pristina, Kosovo*

### **Abstract**

*Passing the global financial crisis on the real sector of the economy which is accompanied by decrease of production, rising unemployment and the decrease of GDP (gross domestic product), marked the start of global economic crisis. Dimensions of this global recession more and more are becoming uncontrolled, and nobody knows how long will it last. Is it possible to think that the global economy is improving after antirecursive measures of President Obama to revive the US economy, which is expected to be the engine of the global economy resurrection. Recent events are showing that the implementation of measures by the US administration are not delivering the desired results in US exchanges that from the first moment of the announcement of the program have decreased to the new minimum. So Dow Jones has declined 10%, while European stock markets continue to decline rapidly after the announcement of the results of business for the last year.*

**Keywords:** global, economic, crisis, financial, employment

### **What are the circumstances of hope for a bailout?**

Here we are dealing with a situation of normal market reaction to which past 25 years there was no state interventionism in a such a grand scale. The market which believes only to the market mechanism is not prepared to accept state measures as a solution to the crisis before these measures show concrete results. Why is so important the success of the US antirecursive measures for the European economy and for the rest of the global economy? First of all we have to do with the possible positive results of the US, from which you can start counting the time to exit the recession and for the rest of the global economy.

Chairman of the US Federal Reserve (US Central Bank), assesses the end of deep recession this year which will impose a series of antirecursive measures and incentive stabilizing programs from which are expected to yield the expected results. At the same time it's warned that the full scale of the economic revival should wait at least two or next three years. From this data it is worth noting that the global economy is close to the border between recession and depression (which is defined as a deep recession) On what will depend the exit from recession? Above all, by promoting fiscal policies and measures to stabilize financial institutions and financial markets. So, the state again have be involved to improve the "mistakes" of the market which mainly appear during periods of high rates of economic growth (prosperity). This mainly happens due to the unscrupulous desire for profit. It is known now that the state has not proved successful owner and managing the economy, for this will have to be made quite an effort to antirecursive measures that are occurring are effective. This is guaranteed only by success, otherwise if success is insufficient, it is possible deepening economic crisis and the continuation of the recession with disastrous consequences for the global economy.

### **Who are the players of which depends on the exit from the crisis?**

However, the revival of the global economy with state measures will depend on the revival of major trade partners of the United States (EU, Japan, China, etc), if improving their economies would be slower, then recession in the global economy will be extended. However, if we consider calling US President a few days, for corporations and US citizens that they buy only products "Made in USA" can not count on a quick revival of its trade partners. The reason is simple, it is known that

the budget deficit of the US depends on the sale of state bonds slap these trading partners. So the budget deficit which is 2 billion a day, can be covered only by a surplus of Japan, China, Germany, Netherlands, Norway, etc. But the question arises how long they will be able to fund because antirecursive measures in the US are still searching before.

European Union these days has decided he does not want to finance a special fund of 180 billion euros to help the economies of the countries of Eastern Europe and the Middle East. When Hungarian Prime Minister attempted to provide first aid to Hungarian economy which is before the financial collapse, but also to neighboring countries, this initiative was opposed by one of the rare members of the EU, which have a surplus in the balance of payments, Germany. Chancellor Merkel thinks that aid to ten new member countries which joined the EU before 5 years, in fact, would be something excessive. And in the end, we can say that beginning prosperity in the global economy will depend on the success and duration of antirecursive measures are being undertaken by the economies of the most powerful countries in the world. This at the same time is the only way of exiting the economic crisis that has included the world. So the likelihood of exit from the crisis for the global economy are real, but that will last 2 - 3 or more years, none for now can not be sure. However, one is now known that all state economies are taking antirecursive measures through stabilization programs, in order to save what is likely to be saved, in this situation of unprecedented global economic crisis in the last 80 years in the world economy.

### ***The economic crisis and the end of the global neoliberalization***

The necessity of changes in the character of globalization is becoming more and more a matter of priority for all powerful states of the world. They are in this time of economic crisis the only way out is see, humanization of globalization processes through state mechanisms, implementation of state regulators at national level as well as supranational level. Thus, through oversight and democratic control, with the sole purpose of this process to be tailored to the needs of humanity.

Globalization is the process of the current situation in which our world is today. We are dealing with a new era which has not yet been reordered, which marked the end of the old world order known now. In which the main actors in international relations were national states, topped with world superpowers that have defined the direction of world development. In other words, globalization symbolizes the era of creating a new world which is still undefined. This process began 20 years ago and was appointed as the new global order which acted as financial capitalism super or fundamentalism of market. For this reason there are much controversy about the definition of globalization as an objective process which encompasses humanity. While some identify with the development, prosperity and peace, others perceive as stagnation, disaster and destruction. It which is common and uncontested in all definitions is the attitude that globalization is a process of economic, social, political and cultural, whose actions go beyond national states. So globalization is complex and controversial process of building the world as a whole and is related to: 1. economic union in the world market uniformed forms of production and consumption, 2. democratic union of the world on the basis of the existence of interest humanity, such as equality, protection of human rights, rule of law, pluralism, peace and security, and 3. moral unity of the world about some humanitarian central values necessary for sustainable economic development of humanit.

### ***What are the positive aspects of globalization which nobody can deny?***

The processes of globalization of the market economy and the effects can know in all aspects of our daily lives in our neighborhood near the uniformity of the same products for general consumption (food products and techniques, all can be purchased in supermarkets So in one place, without going abroad). Further development of high-tech information has transformed the world in the "global village", via the Internet, global television channels such as CNN, mobile phones which even children use today. So in every present moment with all links and information on everything that interests us and around us. See globalization processes in circulation unlimited economic and financial transactions in the stock, which deals with transnational capital property, factories, companies, which have included every corner of our planet. Specifically current global economic crisis, which flows starting from the US, overnight have included world. All this is so painful reflects the fact that as globalization processes have conquered the world. Positive parts globalzimit nobody can deny: the development of high-tech fast, removal of customs barriers, the development of global communication, all this at a global level has raised quite average standard of life; personal and public standard, it can be seen from the exact data such as utilization and enormous growth of electricity consumption, automobile, radio - television, telephone and other technical means for the head of a person in the world. Then, average human lifespan that has become almost twice as long, it mainly

applies to developing countries. Dramatically is spread democracy in the world, human, racial, gender rights have increase, and child labor have declined. It have significantly increased the number of those literate, while global poverty has decrease.

### ***What are the downsides of globalization, where globalists are based to?***

However, negative aspects are consequences of globalization are quite a lot expressed. Opponents of globalization, the so-called anti-globalization are denying some of the achievements and advantages of globalization mentioned above. They claim that global poverty is increasing and not diminishing, is increasing the gap between rich and poor. This is justified by the unequal distribution of global wealth. The richest 20% of the world population possess 82.7% of the overall wealth of the world. But with the poorest 20% just 1.2%. According to Nobel Laureate Paul Krugman in the US, the disparities are greater than during the world economic crisis of the years 1929 - 1933's, although wealth and efficiency of the US economy is so powerful boost. In the period 1970 - 2007, only 0.1% of the richest have their six-income, while the average salary was 12% smaller.

While global industrialization and pollution of the environment has to follow "global warming" which is affecting the melting of glaciers in the North Pole and South. Other global climate change negative, as is damage to the ozone layer, deforestation, extinction of many plant and animal species. Is also growing global organized crime, drug cartels, the mafia, drug trafficking, people and weapons. The world is threatened by global terrorism, not far these groups first operated mainly in their countries such as the Red Brigades in Italy and factions of the Red Army in Germany. But today Al Qaeda is attacking the whole world, from the US and Europe wide in Iraq, Pakistan, the Philippines, including the recent attack in India in Mumbai City.

One of the main negative factors of the process of globalization is weakening the lack of oversight and democratic state in terms of economic globalization. Where directly have consequently weakening the impact of trans-national financial transactions. Without the possibility of public oversight of transnational capital enables drain in the countries called "tax heaven" as exotic countries as Kajmone Islands, as well as European tax havens (Monaco, Liechtenstein, Luxemburg), where the minimum tax paid. These countries have become long since financial uaza money laundering coming from the world of organized crime. While industrial production very quickly and massively is moved from West to East due to very low wages of labor, miserable working conditions and environment. All this has resulted in a reduction of production costs for transnational companies. The Chinese economy is the biggest beneficiary of globalization and the best illustration of the positive and negative sides of the globalization process. As a leading global industrial products China is achieving enormous profits and high trade surplus which is expressed in increasing the standard of living of its inhabitants. On the other hand, in a small Chinese province and invisible inhabitants are dying en masse from cancer diseases as a result of environmental pollution from waste industry which works without environmental protection.

### ***On is basen the neoliberal doctrine on the global economic libertarianism***

The doctrine of economic neoliberalism and globalization neoliberal ideological core is built on the principles of minimal state and the freedom of unlimited private property right. Neoliberalism in this sense is close to the philosophical theory, political and economical now known by many authors as libertarianism. Libertarianism is the extreme form of unilateral economic liberalism.

Libertarianism supported and committed to absolute freedom and autonomy uncontrolled market, private property, extreme independence of individuals, legal governance, supported only in the framework of the "minimal state". Whose function is to guarantee relationship "fair" for freedom of unrestricted market. From this powerful libertarianism denies any type of state supervision. Based on the belief that the market is self-regulatory competition which leads to the progress of humanity and the universal freedom of his own. From this neoliberal doctrine of libertarianism is committed to the cessation of state supervision transboundary movement of property, capital, goods and services. Also opposes state control of prices, wages and commercial transactions. It further requires the privatization of the economy overall production mainly goods and services, and reducing state social security guarantees for workers, such as minimum wages, working conditions and environmental, job security! In short libertarianism denies neoliberal state economic development strategy which has dominated the first period of globalization. The ideology of neoliberal globalization (libertarianism) supports the de regulation

- the removal of legal norms and democratic oversight of the state. According to this "other way egziston not", "a secret hand of the market to solve all problems", the removal of moral norms, "Greed is good" because of passion and encourage ambition and innovation!?.

### ***Why State Interventionism caused the end of neoliberal capitalism?***

In the developed West countries capitalist system has changed from the industrial capitalism which has promoted the interests of labor and capital, which is now before the financial super capitalism where money dominates over people and resources. This is the period of neoliberal capitalism and the global market fundamentalism. To the global economic neoliberalism occurred "ideo-lottery" of money which has suspended organic links with the work. So the so-called "Rolet-economy" is based on free cash, loans and debts. This has caused that financial derivatives (products) exceed 11 times the real global economy (production). Namely it has become the main driver of current support economic crisis global financier, globale. system happened financial pyramids.

Therefore, the manifestation of the global economic crisis have caused large debts public and private, i.e. the enormous growth of the fragile economy standing credit borrowings. No transparency credit and bank debts through "financial packages" banks and financial funds have sold one another bad debts to the extent that at the end now, how much it owes. Then in all this question as apply these banks and companies that have gripped the enormous debts. As a result now is not caused widespread belief in international stock markets, which as a result have freezing credit and lending. This era of globalization has caused global spread rapidly to the tsunami crisis. That was followed by a drastic decline in economic activity (decline of economic growth, investment and exports decline, decline of productivity, increased unemployment). In a word the global economy is experiencing unprecedented recession until now, the size of which, some analysts say the recession is more severe than the global crisis years 1929 - 1933's.

In these circumstances the state intervencionizimi was more than necessary, all this results in the end of neoliberal capitalism (Lisser - faire) and return the state to the role of guarantor of justice, faith and the defense of citizens. Return to the state keynesianism of the majority of the most developed states in the beginning of the year are taking as a matter committed (USA, Germany, England, Japan, France, etc.). In order to avoid a greater evil, total collapse of the state economic system and the global financial system.

### ***State economic system and the global financial system.***

The States with taxpayers money getting rid of the private interest of companies, banks and improve the errors are financial managers. Who rather than be responsible, they are rewarded with higher income and scandalous other associated fees. Hence there is an imperative need supervision become democratic state of transformation and globalization among the national territory, which for a long time have spoken critics of the current globalization. This was expressed in two conferences held within the past few months the G-20, the most powerful economy in the world. Their goal was to be taken necessary measures to prohibit the effects of the global economic crisis. Particular emphasis is paid to financial discipline through national and global regulators. He asked gjithastu necessary reform of the global financial system and the international Financial institutions. Namely emphasized that the New Global Order has functioned for the past 20 years, must change. Why social democratic oversight - liberalism provides humanization of globalization As for the theory as well as practice of neoliberal globalization, the most distinguished critics are Jan Art Scholte, Ulrich Beck, then laureate economists Joseph Stiglitz, Paul Krugman, James Tobin. Then known philosophers: Jangoman Houchler, and theologian Hans Kung. A long time they were committed to democratic reforms of globalization, which are not only possible but are also easily achievable. According to them "globalization is not natural disaster before which people are powerless", this process can and should be checked. Since 10 years ago Kung has attracted confront them, that globalization should be put under democratic supervision. Because uncontrolled its development led to transnational capital selfish interests sooner or later will lead the world in major economic crisis. Namely wide will come to breaking the world economic system, then the changes will be necessary but long overdue. But always it is good that reforms be implemented before, than after the crisis and economic breakdown. Current global economic crisis which is deepening so painful is proving diagnosis of Hans Kunges and many critics of global neoliberalism. Kung has provided therapy ethical framework of global democracy founded on global ethics, respectively koncenzuesi for universal rights and human responsibilities. His humane conditions of

globalization are: supervision policy on the economy, then the ethical oversight on politics and economics. So it is necessary to rivëhet mandatory system of global governance (not world government), a certain form of global kenziänizmit (supervision of states). So as social economy represents and defines SOCIAL capitalist liberalism. Accordingly, the reaffirmation of social-liberalism authentic, as distinguished from social and economic policies of neoliberalism. It focuses excellent opportunity for SOCIAL-liberalism which encourages the promotion of individual rights, social, cultural and freedom of citizens. So we are dealing with social-liberal economy that is based on the balance of the interests of capital and labor, the rule of law and liberal democracy in which all citizens have equal rights before the law.

### ***Can humanity to avoid globalization and its impact***

Globalization is not only inclusive process of rearranging the world, but it is a process of transition to global society and the beginning of the global period. If this is correct then the question is, is there another alternative globalization decipherable. Globalization is impossible to avoid this objective process that is happening humanity has become like the air we breathe definitely should. Some countries may partly be isolated and be less under the influence of globalization processes. But as I show indexes measuring globalization (KOF-i, was a Swiss think tank), are the least globalized developing countries and poor equatorial Africa. In other words, isolation shpjën in poverty and back waste, on the other hand is not possible to avoid the negative sides of globalization as it is now the global economic crisis. From all of this can be highlighted, that the necessity of changes in the character of globalization is becoming more and more a matter of priority for all states botës. Ato powerful in this time of economic crisis the only way out is the view, humanity globalization processes, through state mechanisms, implementation of state regulators, as well as at national level mbinacianal.

### ***The global crisis affects Kosovo***

Economic affairs expert say that Kosovo authorities shall take appropriate measures for controlling the global economic crisis, which has begun to feel even in Kosovo. According to them, the social economic situation of the citizens of Kosovo more and more is deteriorating global economic crisis. The Kosovo government should take appropriate measures to cope with the global economic crisis, experts estimate for economic issues in Pristina. According to them, now in Kosovo only are being observed directly and indirectly the first signs of crisis. The global economic crisis has not affected greatly Kosovo, but that the first elements are only now being seen. "The first elements of the crisis is seen as appears in the export sector, which in recent months seen a slowdown in exports trends Kosovo against states in the region and Western Europe". To what extent could the Kosovo economy affected by the global crisis, he says that this will depend on the trends taking place in world markets. According to him, if the industrialized countries, which are mostly affected by the global crisis, take appropriate and adequate steps to absorb this crisis in terms of time as short, then reпреkucionet Kosovar economy will be lower. "2009 and 2010 will be a great challenge for industrialized countries, in order to try to constrain the global crisis. If the effects of changing the depreciation is quickly observed in industrialized countries, the crisis will also affect more Kosovo". Recommends relevant government institutions to monitor as close to the situation and conforming changes or risks, which may have implications in certain sectors, to undertake concrete steps in order to minimize the global economic crisis. Meanwhile, the expert on economic issues, Dr. Bedri Selmani, says the social economic situation of the citizens of Kosovo more and more is deteriorating global economic crisis. "The financial crisis and global economic recession now certainly will influence also in Kosovo, directly and indirectly," he emphasizes. According to Professor Selmani, directly Kosovo economy will be affected due to foreign disinvestment, which are expected to occur in Kosovo, meanwhile indirectly Kosovo loses more, because, as he puts it, a large inflow of material that The Kosovar economy come from abroad, are reduced. Salman says that without such revenue coming from abroad, Kosovo can not remain as the economy. Another element that can be concluded that Kosovo is affected by the global economic crisis, according to Professor Selmani, is the lack of buying power in the Kosovo market. According to him, since the beginning of this year is the first that has been declining purchasing power of the market from 30 to 40 percent. "It is a period when Kosovo needs stability. It must be initiated by the reforms, which will change and will do to start functionalism of state institutions and economic stability," said Selman. Meanwhile, experts recommend for economic issues of the Government of Kosovo to enter the economic stabilization program, which will enable the exit from the economic crisis.



---

**Literature**

- 1 Joseph Nye, „Globalism Versus Globalization“, në: [www.theglobalist.com](http://www.theglobalist.com).
- 2 IMF Staff, “Globalization: Threat or Opportunity?”, 2000, në: [www.imf.org](http://www.imf.org) .
- 3 Mehmet S. Aydın, “Küreselleşmeye Genel Bir Bakış”, në: grup autorësh, *Siyasi, Ekonomik ve Kültürel Boyutlarıyla Kreselleşme*, Ufuk Kitapları, Stamboll, 2002, f. 13.
- 4 Mehmet S. Aydın, po aty, f. 11; <http://en.wikipedia.org> [www.rrojasdatabank.org](http://www.rrojasdatabank.org).
- 5 Shih web faqen Global Issues That Affect Everyone: [www.globalissues.org](http://www.globalissues.org).
- 6 Shih Keith Porter, „The Future of Terrorism“, në: <http://globalization.about.com> dhe Asta Maskaliunaite,
7. Shih p.sh. Michel Chossudovsky, “Global Falsehoods: How the World Bank and the UNDP Distort the Figures on Global Poverty”, në: [www.transnational.org](http://www.transnational.org).
- 8 Guy Pfefferman, “The Eight Losers of Globalization”, në: [www.theglobalist.com](http://www.theglobalist.com).
- 9 David Brooks, „Good News about Poverty“, në: [www.columbia.edu](http://www.columbia.edu) .
- 10 Charles Kenny, “Why Are We Worried About Income?”, në: [www.sciencedirect.com](http://www.sciencedirect.com)
- 11.UN-HABITAT, “Cities and Globalization: A Race to the Bottom?”, në: [www.unhabitat.org](http://www.unhabitat.org) .
12. Dr.Bedri Selmani GLOBALIZIMI Tranzicioni dhe Integrimet Prishtinë (2006).
13. Dr. Radovan Vukadinoviq Marrëdhëniet ndërkombëtare nga Lufta e ftohtë deri te rendi global Prishtinë 2007

---

## Enhancing Youth Employability as a Result of Creating Linkages between Vocational Education Sector and Private Agricultural Sector in Kosovo

PhD(c) Emine Daci - Zejnullahi, PhD(c)

Petrit Bushi

[eminedaci@hotmail.com](mailto:eminedaci@hotmail.com),

[petrit.bushi@universitetiaab.com](mailto:petrit.bushi@universitetiaab.com)

AAB University

Prishtinë, Kosovë

### Abstract

*The agribusiness and Agriculture sector is the main field of economy in Kosovo and it is sector that contributes to social viability, employment and economic development. While in Kosovo on the basis of statistics from the results of the Kosovo labor force survey 2014, shows that Kosovo stands in the worst labor market situation in comparison to the Western Balkan countries and the 27 European Union member countries. The unemployment rate in Kosovo is 30%, from these percentage 55.9% of the unemployed were young people (aged 15-24 years) and the share of female population is higher 68.4%. The labor force participation rate in Kosovo is 40.5 % while the participation rate in Western Balkan countries ranges between 60 to 68% and it is 71.8% in European Union countries. Part of these differences is due to the fact that Kosovo has such a young population and many of these young people are still in education (and therefore classified as inactive). A concern is that over time the potential for the inactive population to grow remains high as each year approximately 36,000 young people will enter the working age population (i.e., 14 year olds will become 15 year olds) while only approximately 10,000 will leave the working age population (i.e., 64 year olds becoming 65 year olds). Very strikingly, the labor force participation rate of women is significantly lower in Kosovo than its neighbors<sup>1</sup>. This study intends to serve as a key tool for identifying the gaps between vocational education sector and private agricultural sector in Kosovo, which impact directly to the unemployment rate. The research addressed identified gaps of the VET schools and Private sector, their needs, areas of focus, specific needed activities in order to create the favorable conditions to link these two important sectors and enhance youth employability.*

**Keywords:** VET schools, agribusiness sector, youth employment,

### Introduction

In order to have better understanding of gaps and needs of Agribusiness sector and VET schools, we conducted the assessment with private sector companies and three main VET schools in Kosovo. Considering the agriculture and agribusiness fields as main potentials of rapid youth employment, the Kosovo government with the support and cooperation different donor agencies and organization experienced and active in this sector aims to enhance and support this potential among youth of 17-20 ages who graduate in vocational secondary agriculture schools, enhancing of the youth employability should work on improving theoretical, practical needed skills and linking with private sector. Through these efforts they should up upgrade the level of qualitative professional skills among youth in order to enhance their opportunities for employment during attending or after completion of secondary vocational education. On the other side it seems to be a low interest of Kosovo society, particularly of youth to work in agriculture, even though this society has a long tradition working in agriculture and Kosovo has an appropriate terrain / land and climate of growing agriculture products. So far, in Kosovo we miss tracer information about youth who have already completed the secondary vocational education in agriculture. Where and how they may have continued their further career, through continuation of University studies or through employment / self-employment in the agribusiness industry (or others), even the second issue is not as sustainable as the unemployment level among youth in Kosovo is very high. Unemployment and its impact on young people are serious issues that affect the development and wellbeing of Kosovo youth. In a region where there is high youth unemployment, young

---

<sup>1</sup> Kosovo Agency of Statistics

---

people must be recognized as a resource for progressive economic development; therefore, the Government should create mechanisms to ensure that young people are involved in the economic development strategies, and that youth issues are considered as a priority<sup>1</sup>

### Objectives of this research

The objectives of this assessment are to:

- Develop a clear understanding of needs and the state of targeted VET schools and private agribusiness sector;
- Identify gaps and opportunities that can be addressed by Kosovo institutions and different donors active in this sector
- Develop specific approach and intervention methodologies and activities

### Materials and Methods

The Questionnaire was conducted throughout Kosovo; first we developed selection criteria/methodology through including main subsectors, three levels of businesses and all value chain actors. Whereas businesses that were interviewed were selected based on these criteria:

- Small, medium and large agribusinesses
- Agribusinesses with potential growth for enhancing youth employability.
- Agribusinesses which were based in the same region as Agricultural VET Schools.
- Businesses that are registered (legal)
- Businesses they have products in the regional and international market
- 

Interviews were carried out face - face with high level of management: owners, directors, coordinators etc. In terms of business activity all value chain actors were involved such us: producers, processors, traders, service providers etc. The sample was classified into municipalities' and regional level, based on the presence of the representative agribusinesses; the sample was different from one to other municipalities and from one to another region and level of businesses. The assessment was based on quantitative analysis and qualitative analysis. The 100 questionnaires were conducted with the agribusiness companies, 234 with VET students from the three schools and qualitative data with three school directors of VET schools from Pristina, Peja and Ferizaji.

### Results of research

#### Results obtained on the ground

Figure 1: % Assessment of business subsectors: producers, processors, traders, service providers,

The majority of the respondents, about 67.0% answered that they belong to the producers sector, while 18 % of respondents were from the processing sector, 14 % of respondents were from agribusiness traders companies that deal with export-import, around 1% service providers. It means that the survey was conducted with biggest producers, and big processors, having higher development potential.

---

<sup>1</sup> Kosovo Youth Strategy and Action Plan 2010-2012, page 12.

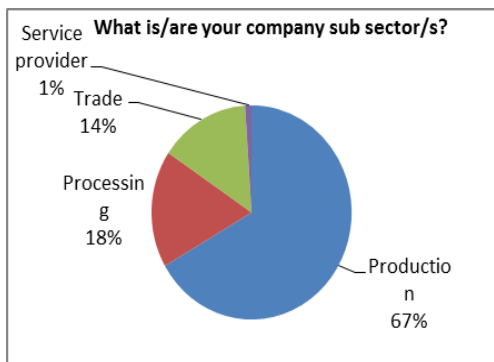


Figure 1: % of company subsectors

Regarding the question "What is the average age of the employees", majority of them 72.6 % of interviewed companies stated that average age is 25-34 years old, while 20 % stated that average age is 35-44 %, 4.2% of interviewed companies has workers in the average age 15- 24 and 3.2 % of respondents stated that have workers in their companies in average age more than 45 year

Figure 2: % of different types of employee contract

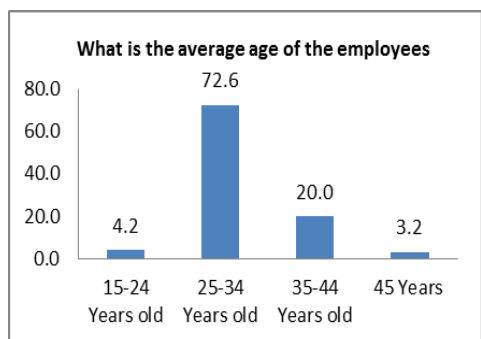
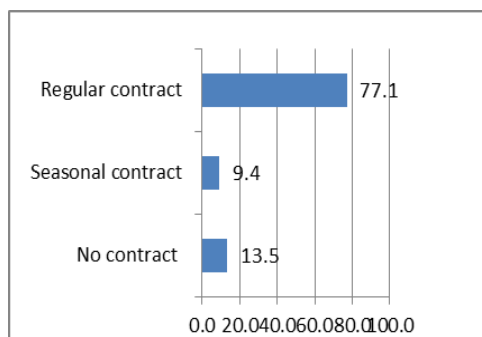


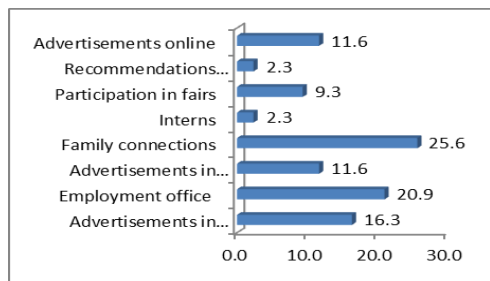
Figure 3: what types of work contract have the Employees



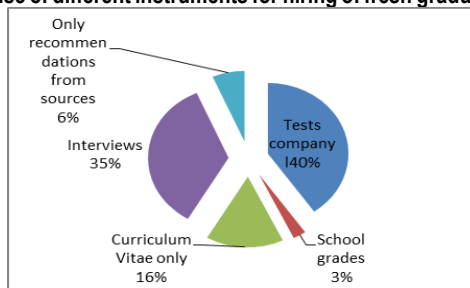
Regarding the figure 3 it is mean that 77.1% of employees have the regular contract, 13.5 % of employees without working contract and 9.4% of employees have the seasonal contract.

According the question "How do you announce vacancies for your employees, especially when they have freshly graduated from school? From the total number of companies 25.6 % stated that they employ fresh graduate through family connections, while 20.9% through the Employment office, 16.3% advertisement in newspaper and 11% of stated they announce

**Figure 4 : % of different announcement of vacancies**

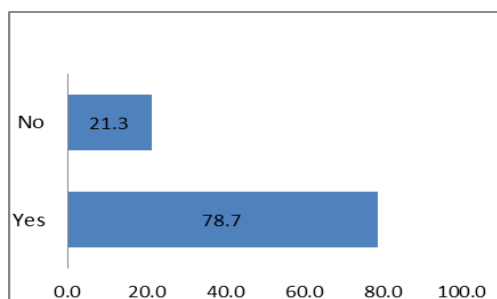


**Figure 5: % of company's opinion regarding use of different instruments for hiring of fresh graduates**

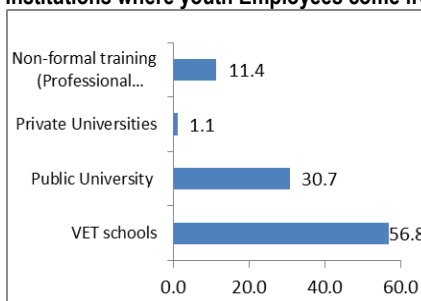


Regarding the question about the means that companies use for hiring the fresh graduates 40% of companies stated that they use test at their company, 35% using interviews and 16% looking to the Curriculum vitae and very low % about 6% consider the recommendations. It is meaning that most appropriate tool for youth employment is tests at their company and interviews. Regarding the figure 6 the most of companies around 78.7% stated that they satisfied with the youth work (fresh graduates) and 21.3 % give the negative opinion regarding satisfaction with youth work.

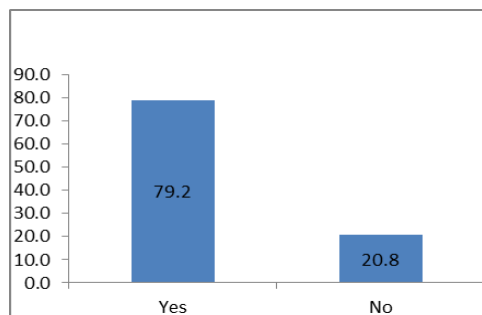
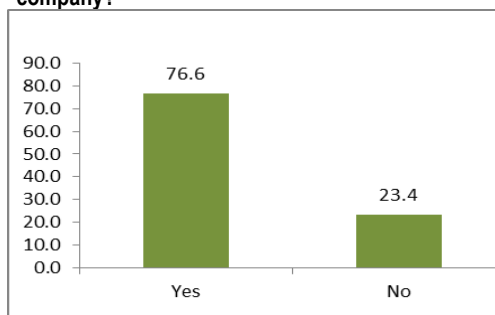
**Figure 6: % of satisfaction with youth work**



**Figure 7: % preferences of companies for Institutions where youth Employees come from?**



It is interesting that the private sector around 56.8% preferred young employees to come from VET schools, while 30.7% from public universities, 11.4% from professional certification institutions and very low % from private universities around 1.1%. So agribusiness companies are optimistic about students that came from Agribusiness VET schools. Findings indicate that about 79.2% percent of companies stated that they are interested to employ young people from VET Schools while 20.8% percent they aren't interested. In conclusion the agribusiness companies seem to be very interesting in employing the youth from VET schools.

**Figure 8: Are you interested to employ young****Figure 9: Did you ever have internships in your company?**

### People from VET Schools

According to the figure in left side 79.2 percent companies are interest in employing the youth form VET schools. Results presented in Figure 9 reveal that for almost 76.6 percent had the internships while 23.4 percent didn't had internships before. Since in the figure bellow is presented the joint activity between Companies and VET schools, most of the joint activities were the exchange visits 73 percent, participation in job fairs 20 percent while other activities as open school days and participation of student in joint promotion of companies' products are in very low level.

Table 1 outlines the % of companies interest in particular profile. It seems the interviewed companies are more interesting for wood technology (100 %), Horticulture profile (62.0%), food technology (57.8%), plant protection (10.8%), crop and vegetable production (10.8%) while the other profile are less required from the agribusiness companies. It is mean that we have to target the students from these profiles and link with the companies in order to address their needs and contribute to youth employability and employment.

**Table 1: % of inters of companies for Agribusiness profiles according to sectors and subsectors**

Nr.	VET Agribusiness profile	Yes (%)	No (%)
1	Farmer profile	9.5	85.5
2	Horticulture	62.0	38.0
3	Crop and vegetable growing	10.8	89.2
4	Food technology	57.8	42.2
5	Veterinary	2.4	97.6
6	Forestry	4.0	96.0
7	Livestock	3.6	96.4
8	Plant protection	10.8	89.2
9	Tree –viculture	6.0	94.0
10	Wood technology	100	0

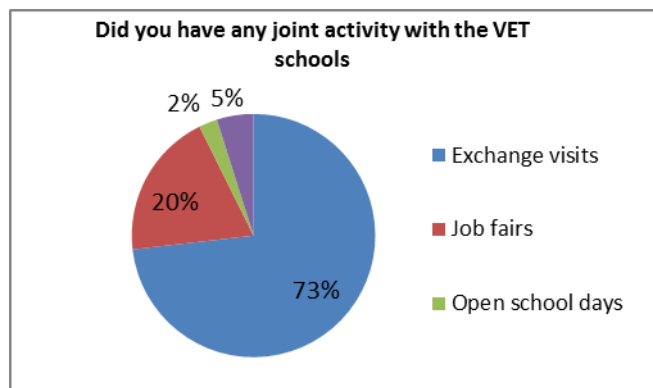
Table 2 outlines the % of importance of different working skills of VET students for agribusiness companies. It seems the very important skills for interviewed companies are these skills: skill to do "Quality of work, attention to details" (90.8 %),

Team working (84.5 %), Knowledge for using equipment (75.6 %), experience in similar positions (61.2 %), Communication Skills (59.8 %), interpersonal skills (53.7%) and important skills are Formal education (64.3%), Foreign language skills (57%), Training and certification (54.8%).

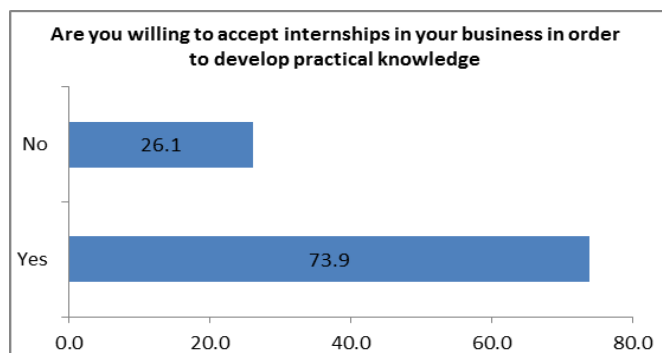
**Table 2: % of importance of different working skills of VET students for agribusiness companies**

Nr		Not Important	Important	Very important
1	How important is the work experience in similar positions	3.5	35.3	61.2
2	How important is Formal education	8.3	64.3	27.4
3	How important is the Trainings and Certifications	20.2	54.8	25.0
4	How important is the Knowledge using equipment	3.7	19.5	75.6
5	How important is the Foreign language skills	14.0	57.0	29.0
6	How important is the Communication Skills	8.0	32.2	59.8
7	How important is the Interpersonal skills	7.3	39.0	53.7
8	How important is the Quality of work, attention to details	9.2	0.0	90.8
9	How important is the Team working	15.5	0.0	84.5

Regarding the question 10<sup>a</sup> "Did you have any joint activity with the VET schools", 73% of companies interviewed stated that one of activities which was most frequented is exchange visits between two sectors, 20% job fairs, 5% of companies stated that they engaged student for promotion of their companies product, while very low percent 2% in open school days. It is meaning that one of most appropriated activities between these two sectors is exchange visits and job fairs.

**Figure 10: % of joint activities between companies and VET schools**

Regarding the question in the figure 11 "Are you willing to accept internships in your business in order to develop practical knowledge" most of companies 73.9 percent gave the positive answer while 26.1 percent stated no.

**Figure 11: % companies willing to accept internships in their companies**

The most of companies in the past supported the internships activity with providing to the students the additional contribution like: food, transport, half wage, and paid training course. In line with responses related to the different contributions of companies for internships most of the companies 67.1 percent stated that they provided food for students, 33.0 provided the half wage, 31.8 provide the transport and 21.2 percent of companies stated that they have paid training courses.

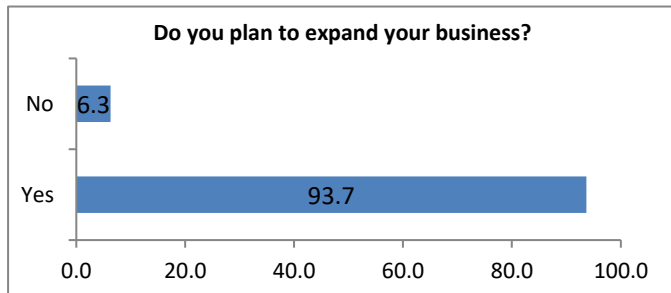
**Table 3: % different contributions of companies' for internships**

Nr.	Contributions of companies for	Yes (%)	No (%)
1	Providing food	67.1	32.9
2	Providing the transport	31.8	68.2
3	Half wage	33.0	67.0
4	Paid training course	21.2	78.8



In the Figure below regarding the question about “Do the companies plan to expand their businesses”, most of them 93.7 percent declare yes and low percent 6.3 percent declare no.

**Figure 12: % companies that plan to expand their businesses**

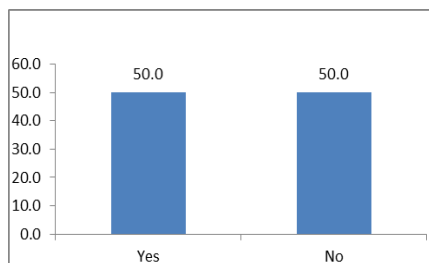


In addition regarding the question about the plans of companies in future 93 present of companies plan to expand their businesses while 63% increase productivity, 50% increase number of employees and low number of companies stated 44.4 percent are interest to expand new product.

**Table 4: plans of companies in future**

Nr.		Yes (%)	No (%)
1	Do you plan to expand your business?	93.7	6.3
2	Do you plan to increase number of employees	50.0	50.0
3	Do you plan to expand your business increase productivity	63.0	37.0
4	Do you plan to expand your business with the new product	44.4	56.6

With regard to question which is presented in the figure 13 we receive very interesting answer that 50 percent of companies declare that they plan to increase number of employees and 50 percent no. It is mean that we are satisfied with the businesses declarations regarding the potential readiness to increase number of employees

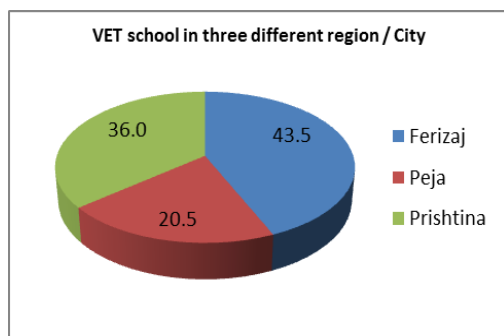


**Figure 13: % companies that they plan to increase the number of employees in near future**

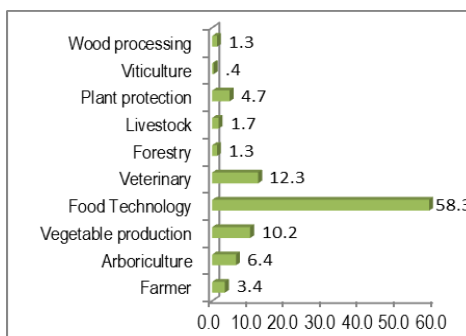
**Assessment of VET student of agribusiness schools**

The assessment was also conducted with the 234 VET students in three Agribusiness VET schools: Abdyl Frasherri in Prishtina, Zenel Hajdini in Ferizaj municipality and Ali Hadri in Peja municipality. 234 students were interviewed face to face in order to identify their gaps and opportunities regarding employability and employment. The interviews were distributed in the three schools based on number of VET student that schools possess and the profiles that businesses are interest. The 43.5% of student interviewed were from school “Zenel Hajdini”, 36.0 % from VET school “Avdyl Frasherri” and 20.5% from VET school “Ali Hadri”.

**Figure 14: % of students interviewed in the three**



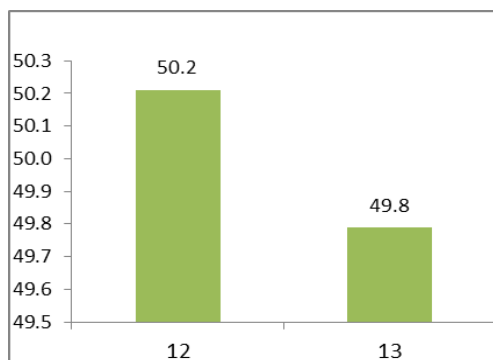
**Figure 15: % of different profiles of students interviewed VET schools**



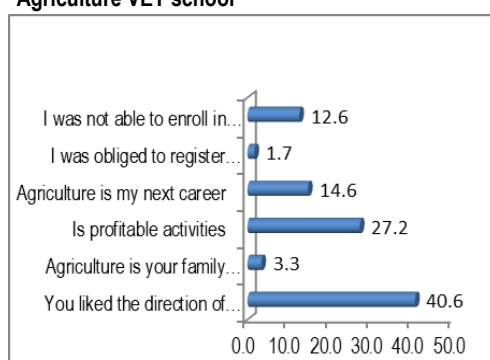
The different profiles of student were interviewed during the assessment, the one of most frequented was the food processing profile which in this assessment presents 58.3%, 12.3% of veterinary profile, 10.2% vegetable production profiles, 6.4 % Arboriculture profile. The request of KCC to conduct the interviews with the profiles which were most requested from the private sector.

According to the question for VET schools which is showed in the figure 17 below 50.2% of students belong to the 12<sup>th</sup> classes and 49.8 % belong to the 13<sup>th</sup> classes, which mean that almost 50:50 of different classes represented their opinion about skills, gaps and needs.

**Figure 16 :% of different classes that were interviewed**



**Figure 17: how they decided to enroll the Agriculture VET school**



According to the figure 18 above we see that even it was thought that majority of students were enforced from family or they were not able to enroll in other schools, based on the percent presented above most of them liked this field and it was their decision 40.6%, they see that this field is profitable 27.2%, agriculture is their carrier 14.6% and 12.6% were not able to be registered and enroll other schools.

According to the information presented in the table above it is mean that 59.8 % of VET students which participated in the assessment were male while 40.2% female. Even was thought that most of student from the agribusiness VET schools are male it doesn't mean in our case the food technology profile increased rapidly the % of female participated in the assessment. Most of the VET students in this assessment came from rural areas 52.6% which mean potential for dealing practically with this field is possible.

**Table 5: % of basic information of VET student which were interviewed**

Gender		Residential location	
M	59.8%	Urban	47.4%
F	40.2%	Rural	52.6%

Figure 18: % of different student's opinion about their decisions for enrollment in this school

Looking to the answers of students in the table above majority of them stated that they plan to continue the agriculture faculty 85.3 % which is in opposite of other answerers that they are interest to be increase their capacities and know how to find the jobs.

**Table 6: % of student's opinions about market demand for their qualifications**

How do you develop your career in agriculture sector	
I will be employed in agribusiness as technical	10.9%
I will become a farmer	3.8%
I will continue studies at the faculty of agriculture	85.3%

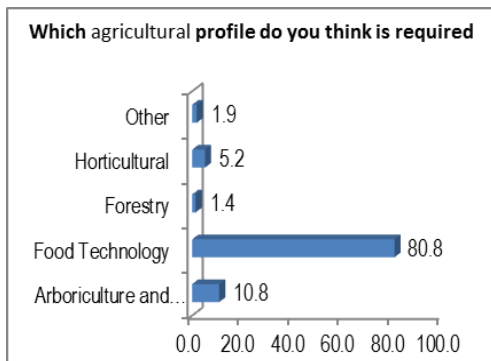
In the table below we can see that more than half of student 50.2 % stated that they do not have information about labor market demand for their qualifications, 36.1 % they stated yes there is demand and 13.7% stated no there is no demand for their qualifications.

**Table 7: % of different options of VET students regarding the labor market demand for their qualifications**

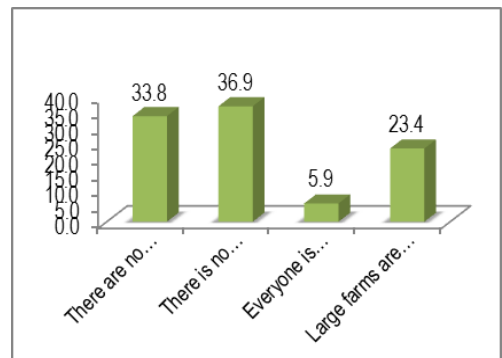
Do you think there is demand in the labor market to hire people with qualifications obtained only by agricultural secondary education	
Yes	36.10%
No	13.7%
I don't know	50.2%

Based on students statements the one of most required profile is the food technology 80.8%, next is the arboriculture 10.8 and horticulture. Which mean that also the number of students is oriented based on their thoughts and opinions in these profiles.

**Figure 18: % of statements of students regarding the profiles**



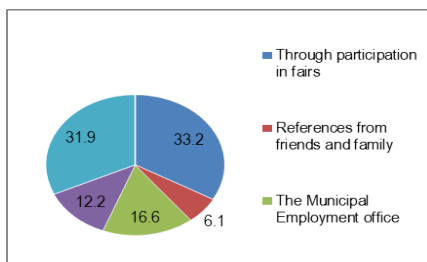
**Figure 19: % of opinions of VET students regarding reasons for Demand for employment of VET students**



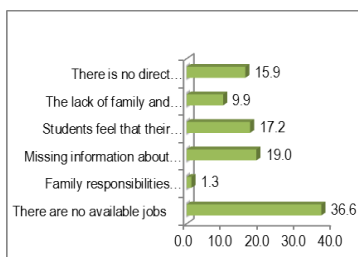
According to the students statement there are few reasons which impacts direct youth employment based on student opinions. One of the most cited is the answer “there is no requirement for employment in the agricultural sector (36.9%), followed by the answer that “there are no large farms in Kosovo” around 33.8 %, 23.4% of students think that large farms are usually family business while small scale 5.9 % is that everyone is involved in Agriculture.

According to the question “Which is most preferred method for job search for young people from VET students” based on students opinion the participation on job fair is the one of most preferred methods around 33.2% followed by 31.9% is the announcements of job vacancies through media, printed media, TV and radio, 16.6% municipal employment office and through the internet 12.2 % .KCC come to the conclusion that organizing the planned activities such as Job fair and cooperation with municipal employment office is in the right track but enforcement with cooperation with media will be addressed in future.

**Figure 20: % of preferred methods for job search to base on students option**

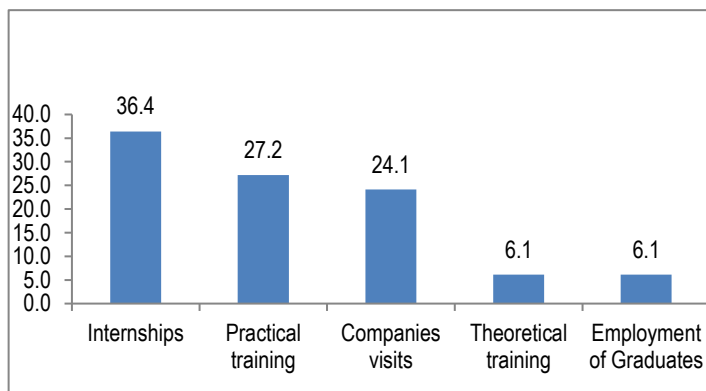


**Figure 21: % of different obstacles that discourage youth to look for jobs**



According to additional question regarding the main obstacles that discourage students to look for job, there are few obstacles according to their statements 36.6 % there are no job available, 19.0% missing information about available jobs, 15.9% there are no direct link and information, 9.9% there is also a nepotism which is one of obstacles.

**Figure 22: % of different efforts by schools for VET students to develop relationship with the private sector**



According to the question "Are there efforts by schools to develop the relationship with the private sector for the continuation of the practice of Agribusiness school students? If yes, what activities, based on students statements there are the initiatives but almost all the activities are in low scale. Internship is one of activity which is most enforced (36.4%), practical training by 27.2% while visits to companies 24.1% and others are in very low scale.

### Discussion

It is estimated that over 50% of Kosovo population is under the age of 30. This fact requires for immediate actions to be taken regarding the education and integration of young generations. A direct consequence of lack of investments in the youth is that a country is wasting young potentials for its development. Youth Strategy in Kosovo adopts an integrated approach for social, economic and political participation of youth in society. In particular, youth need formal and informal education, in line with the needs of labor market, they need youth-friendly health-care services, more security, employment, recreational activities and for participating in decision-making<sup>1</sup>

Although youth employment remains high on the government's agenda, the policy-making process remains characterized by lack of coherence and coordination between ministries and between central and local government. Hence, the most disadvantaged areas of Kosovo have difficulties in translating the objectives of the youth employment policy into programmes that address the multiple disadvantages faced by young people. The provision of well-targeted active employment measures to young unemployed registered at the Public Employment Service (PES) also depends on the enhanced administrative capacity of public employment services. Furthermore, while creating full employment for Kosovo's young people in the short to medium term will not be possible, a number of measures (requiring external assistance to establish and support, at least initially) could go some way towards easing the unemployment tension. Some of these measures are oriented towards raising the level of qualifications of young people and better matching between VET and labour market needs such as: developing tertiary non-university education (which currently appears as a gaping omission in the country's learning framework) or introducing youth-specific and targeted vocational training provision clearly correlated to existing skills gaps.<sup>2</sup>

<sup>1</sup> Strategy components – an overview of youth situation in Kosovo

### Findings from assessment of private sector

Based on the results of quantitative analysis it could be easy to come to the following findings that Agribusinesses that were interviewed belong to small, medium and large businesses. The interviewed businesses belong to these subsectors: big food processing (fruit, vegetable, potato, meat, milk etc), livestock farms, traders (wholesalers, retailers and hypermarket chain), farmers with a large growing area that are large producers of fruits, vegetables and sale them as well. These subsectors were selected for interview bearing in mind the fact that they are subsectors with an increased development and promise generation of vacancies. These are subsectors that impact the macroeconomic development of Kosovo. Their geographical position is in the regions near the VET schools, which is one of the reasons that they are selected and that it is very easy to connect VET schools and companies. Therefore, in terms of the agricultural business that were interviewed, despite many difficulties, the data are encouraging, because more than 80% of them are interested to develop (increase) business, develop new products, increase productivity, and increase the number of employees (especially small and medium businesses)

1. The most average age of the employees around 72.6 % are 25-34 years old. It is mean that agribusiness companies don't have lot employees from the young generation.
2. In the other side the most of companies around 78.7% stated that they satisfied with the youth work (fresh graduates)
3. It is interesting that the private sector around 56.8% preferred young employees to come from public VET schools, 30.7 from public universities, 11.4 from professional certification institutions and very low % from private universities around 1.1%. So agribusiness companies are optimistic about students that came from Agribusiness VET schools.
4. In conclusion the agribusiness companies seems to be very interesting in employing the youth from VET schools and interesting profiles are wood technology (100 %), Horticulture profile (62.0%), food technology (57.8%), plant protection (10.8%), crop and vegetable production (10.8%) while the other profile are less required from the agribusiness companies.
5. Required skills from the companies : skills to do "Quality of work, attention to details" (90.8 %), Team working (84.5 %), Knowledge for using equipment (75.6 %), experience in similar positions (61.2 %), Communication Skills (59.8 %), interpersonal skills (53.7%) and important skills are Formal education (64.3%), Foreign language skills (57%), Training and certification (54.8%)
6. Almost majority of companies plan to expand businesses, increase productivity and most important think increase number of employees.

### Findings from assessment of VET students

The interviews were distributed in the three schools based on number of VET student that schools possess and the profiles that businesses are interest. The 43.5% of student interviewed were from school "Zenel Hajdini", 36.0 % from VET school "Avdyl Frasher" and 20.5% from VET school "Ali Hadri". The different profiles of student were interviewed during the assessment, the one of most frequented was the food processing profile which in this assessment presents 58.3%, 12.3% of veterinary profile, 10.2% vegetable production profiles, 6.4 % Arboriculture profile. Most of the VET students in this assessment came from rural areas 52.6% which mean potential for dealing practically with this field is possible.

1. According to the figure above we see that even it was thought that majority of students were enforced from family or they were not able to enroll in other schools, based on the percent presented above most of them liked this field and it was their decision 40.6%, they see that this field is profitable 27.2%, agriculture is their carrier 14.6% and 12.6% were not able to be registered and enroll other schools.
2. Half of students 50.2 % stated that they do not have information about labor market demand for their qualifications, 36.1 % they stated yes there is demand and 13.7% stated no there is no demand for their qualifications. From % of student which stated that there is demand and one of most required profile is the food technology 80.8%, next is the arboriculture 10.8 and horticulture. Which mean that also the number of students is oriented based on their thoughts and opinions in these profiles.

3. According to the students statement there are few reasons which impacts direct youth employment based on student opinions. One of the most cited is the answer "there is no requirement for employment in the agricultural sector (36.9%), followed by the answer that "there are no large farms in Kosovo" around 33.8 %, 23.4% of students think that large farms are usually family business while small scale 5.9 % is that everyone is involved in Agriculture.
4. According to the question "Which is most preferred method for job search for young people from VET students" based on students opinion the participation on job fair is the one of most preferred methods around 33.2% followed by 31.9% is the announcements of job vacancies through media, printed media, TV and radio, 16.6% municipal employment office and through the internet 12.2 % .
5. According to additional question regarding the main obstacles that discourage students to look for job, there are few obstacles according to their statements 36.6 % there are no job available, 19.0% missing information about available jobs, 15.9% there are no direct link and information, 9.9% there is also a nepotism which is one of obstacles.
6. According to the question "Are there efforts by schools to develop the relationship with the private sector for the continuation of the practice of Agribusiness school students? If yes, what activities, based on students statements there are the incentives but almost all the activities are in low scale.
7. The most required activity to be supported for increasing capacities are: searching for jobs for graduate, participation in job fair , career guidance for students, visit to the company's and support and ensuring of places for internship in private sector.

### Recommendations

Based on findings from the both assessment and in order to address gaps and needs of Agribusiness sector and VET schools aimed to enhance youth employability and employment the institutions should follow up these recommendations:

1. Work very close with private sector in order to increase awareness regarding the Capacities of VET student from VET schools and organize as much as possible joint activities.
2. Identify agribusiness companies which expressed interest to work and have joint activity with the mentions VET schools;
3. Based on the finding and close cooperation with the education sector prepare the list of students which belong to the required profiles from the companies and work close with them to increase required capacities;
4. Organize the trainings and workshops with identified list of VET students in order to increase their capacities.;
5. The trainings should be focused on these required topics in order to increase skills Training on CV writing, interviewing, and job search skills in each of the three regions, conduct training for the project proposal writing, business plan writing;
6. Strength the relations with other stakeholders engaged in this field without omitted public sector such as: Ministry of labor and social welfare, Ministry of education, sciences and technology and regional employment offices;
7. Organize the regional job fairs;
8. Produce the promotion materials in order to increase the awareness and opportunities of all institutions and private sector companies about unused power and capacities of VET students;
9. Establish tracking system that will monitor on quarterly bases number of students employed (inter, part or full time) after the project is completed

### Bibliography

1. Manqellari Ahmet, Hadëri Sulo, Kule Dhori and Qirici Stefan: "Introduction to Economics", 2002, Tiranë.
2. Alliance of Kosovar Businesses: Research on Labor Market Needs, 2012
3. Alliance of Kosovar Businesses: Labor Cost Survey, Prill 2011 Kosovo Youth Strategy and Action Plan 2010 2012, page 12.

4. Hoti Avdulla: Adjustment capacity of labor markets of the Western Balkan countries
5. Hoti Avdulla: Human Capital and Unemployment in Transition Economies: The Case of Kosovo, 2003
6. World Bank: Report on economic situation September 2011, Report
7. Central Bank of Kosovo: Financial Stability Report 2011
8. Statistics Office of Kosovo: "Labor Market Statistics", July 2010, Prishtinë
9. Kosovo statistics Agency: Census of population, households and housing in Kosovë
10. EUROSTAT: Unemployment rate by countries 2011
11. Ministry of Labor and social Welfare, Work and Employment, annual report 2011
12. EUROSTAT: Unemployment in EU 27, July 2012
13. EUROSTAT: Labor Market 2, regional yearbook 2011
14. Strategy components – an overview of youth situation in Kosovo
15. HRD country analysis Kosovo, page 7,
16. Kosovo Agency of Statistics, Results of the Kosovo 2013 labor force survey, JULY 2014
17. ILO, Global Employment trends, 2011
18. Ministria e Bujqësisë dhe zhvillimit rural:Plani për Bujqësi dhe Zhvillim Rural 2010- 13,2010 Prishtine

Web pages:

- [http://www.esiweb.org/pdf/kosovo\\_ETF%20Country%20Analysis%202008%20copy.pdf](http://www.esiweb.org/pdf/kosovo_ETF%20Country%20Analysis%202008%20copy.pdf)(seen 01.03.2015)
- <https://www.worldbank.org/content/dam/Worldbank/Brief/Europe%20and%20Central%20Asia/KOS-Labour-Force-Survey-2013-Eng.pdf>(seen 01.03.2015)
- [http://www.seerural.org/wp-content/uploads/2009/05/ARDP\\_2010-13\\_FINALalb70211.pdf](http://www.seerural.org/wp-content/uploads/2009/05/ARDP_2010-13_FINALalb70211.pdf)



## The Interdisciplinary Possibilities of Literary and Visual Creation: the Case of Jurga Ivanauskaitė

Jūratė Baranova

Department of Philosophy,

Lithuanian University of Educational Sciences

Ševčenkos 31-228, Vilnius, LT -03111 Lithuania

jurabara@gmail.com;

### Abstract

This article deals with the phenomenon of Jurga Ivanauskaitė (1961-2007), considered to be one of the most interdisciplinary and poly-sided Lithuanian women writers and artists. As an artist, as well as a writer, she was impressed by the works of Hieronymus Bosch and Peter Bruegel, and modern surrealists works, such as those of Salvador Dalí, Paul Delvaux, Giorgio de Chirico, and especially René Magritte. She felt a deep closeness with the Mexican painter Frida Kahlo. The main thesis of this study is that, mainly, the encounter with modern Western visual art allowed the writer to break the rules of the established limits of national Lithuanian literature and escape the closeness of the Soviet block mentality and create the new paradigm of "town literature", based on openness to the world and experimentation. Mainly, an interdisciplinary upbringing encouraged Ivanauskaitė to search courageously for new modes of expression in literature and visual painting, as well as in her life style.

**Keywords:** Jurga Ivanauskaitė, interdisciplinary, surrealism, Lithuanian literature

### Why Jurga Ivanauskaitė can be Considered an Interdisciplinary Writer



Jurga Ivanauskaitė was a prose writer, poet, essayist, playwright and artist. She wrote twenty books: two collections of short stories *Pakalnučių metai* (The Year of the Lilies of the Valley, 1985), *Kaip užsiauginti baime* (How to Raise One's Own Fear, 1989); seven novels: *Mėnulio vaikai* (The Children of the Moon, 1988), *Pragaro sodai* (The Gardens of Hell, 1992), *Ragana ir lietus* (The Witch and the Rain, 1993), *Agnijos magija* (Agnija's Magic, 1995), *Sapnų nublokšti* (Gone with the Dreams, 2000), *Placebas* (Placebo, 2003), *Miegančių drugelių tvirtovė* (The Fortress of Sleeping Butterflies, 2005); four personal essay collections *Ištemtas Tietas* (Tibet in Exile, 1996), *Kelionė į Šambalą* (The Journey to Shambhala, 1997), *Prarasta pažadėtoji žemė* (The Lost Promised Land, 1999), *Kelionių*

*alchemija* (The Alchemy of Travels, 2003), two collections of poems *Šokis dykumoje* (The Dance in the Desert, 2004) and *Odė džiaugsmui* (Ode to Joy, 2007), a collection of interviews *Švelnūs tardymai* (The Gentle Interrogations, 2005), two books for the children *Stebuklingoji spanguolė* (The Miraculous Cranberry, 1991) ir *Kaip Marsis žemėje laimės ieškojo* (How Marsas looked for the Happiness on Earth, 2004), diary *Viršvalandžiai* (Overtime, 2008, published post mortem), the collection of plays *Nežaiskite su Mėnuliu* (Don't Play with the Moon! 2008, published post mortem) and the book of meditation *Angelo rūbas* (The Angel's Dress, 2011, published post mortem). Also the collection of three former essay books on her travels in India and Tibet was published as *Tibeto mandala* (The Tibetan Mandala, 2004). Her play *Don't Play with the Moon!*, in which she followed the principles of Antonin Artaud's theater of cruelty and Oscar Wilde's insights in his play *Salome*, was produced by the State (currently National) Drama Theatre in 1987. She also created the decorations for the stage. She had never fulfilled her dream of becoming a movie director and some of her first novels written as movie scripts where her beloved actors from Andrei Tarkovsky's movies were able to play. She also used to make photographs and is famous as a writer-traveller. In 1999 she gave an exhibition of photography show called *Tibet - a Different reality*. Her creativity and world perception were influenced not only by literary contexts (Jack Kerouac, Saulius Tomas Kondrotas,

Ričardas Gavelis) but also by surreal art ( Hieronymus Bosch, Pieter Bruegel, Salvador Dali, Paul Delvaux, Giorgio de Chirico, Šarūnas Sauka and especially – René Magritte), classical art (El Greco, Mikalojus Konstantinas Čiurlionis old sacral painting and others), cinema (Luis Buñuel, Ingmar Bergman, Andrei Tarkovsky), theatre and music (John Lennon, Jim Morrison, Philip Glass, Arvo Pärt), philosophy (Albert Camus, Jean Paul Sartre) and other theoretical literature. The works of Mircea Eliade and Carl Jung formed Ivanauskaitė's interpretation of the relationship between the East and the West. Ivanauskaitė also adopted some of Jung's principles of existential auto-therapy – she actually reiterated Jung's idea of drawing mandalas to restore spiritual harmony. She was also interested in the life and works of exceptional female mystics such as Hildegard of Bingen and Simone Weil. Jurga Ivanauskaitė was one of the most intellectual Lithuanian writers of the twentieth century and of the turn of the twenty-first centuries. Her works have been translated into thirteen languages, including English (2002b, 2002c, 2004e, 2010, 2011b, 2013a), Latvian (1998, 1999b, 2000b, 2001a, 2006b, 2013b), Polish (2001b), Hungarian (1997c), Russian (2002f), Estonian (1997b), German (2002d, 2002e, 2005), Swedish (2005c), French (2003c), Croatian (2003e, 2004f, 2008), Czech (2006c), Italian (2010c, 2013c), and Slovenian (2014b).

On the other hand, she was also an artist. In 1980 she graduated from M.K.Čiurlionis Art School. In 1985 she completed her studies at Vilnius Art Academy, where she majored in graphic arts. When she graduated, she received the diploma of a poster artist, following in the footsteps of her father, a Russian scenery and poster artist in Leningrad (currently Saint-Petersburg), Igor Ivanov. As a teenager visiting Leningrad with her class, she became acquainted with her father's surrealist works. She illustrated her own books and some by other others. Ivanauskaitė's visual works as well as her literary creation from the early period are significantly influenced by surreal symbolism, in some cases - interwoven with Japanese art. The literary works are stylistically dominated by a playful witty surrealism reminiscent of René Magritte, while the literary text is constructed with the question 'what if?' in mind (The Year of the Lilies of the Valley). When she started to write literature she abandoned visual art. But ten years later when traveling in India Ivanauskaitė returns to visual art: she draws Mandalos, a cycle of 110 mandalas. She approaches this cycle by way of realizing their conceptual meaning, similarly to Jack Kerouac's character Japhy from the novel The Dharma Bums. Her actions follow Carl Jung's assumption of the mandala as a harmonizing auto-therapy. The cycle Mandalos is an example of Jung-esque surrealism in which the existential, especially death fears, experienced by the artist-writer are entwined with the pressure of a foreign culture and its deities, the reflections of Western surrealism, and her own creative wit.

Although *Tibeto mirusiujų knyga* (The Tibetan Book of the Dead, 2002), a cycle of nine paintings, was created upon when the artist-writer's return to Lithuania, on the mental level it still symbolizes the running of Tibetan imagery in her creative periphery. This cycle reveals the different planes of existence that were among the pillars of support to Ivanauskaitė's worldview.

During the post-Tibetan period, Ivanauskaitė creates a cycle of unique visions, *Angelariumas* (The Angelarium, 2005), in which she reaffirms the idea of an ecumenical longing for sanctity that covers different faiths. Some of her angels have stepped from the pages of the Koran, others from the Kabbalah, still others were inspired by Biblical symbolism. They are gorgeous and playful, and at times it seems they were created in a light-hearted mood. They are unusually, almost cosmically, magnified in comparison to the small figures of young red-haired girl as possible painter's alter ego and animals below. Conversely, they are, in their own way, prophetic. The technique used in making them brings to mind the tradition of Easter palms, or verbos, of the Vilnius region. The angels are painted or glued together from dried flowers, leaves and blades of grass familiar to Ivanauskaitė. She said: "Regular colours don't suit angels. So I made them as collages of the many varieties of colours and 'fabrics' of herbs and flowers that I collected. I referred to the Kabala and read the Koran, and I realized that angels are the only entity that unites all religions" (Jarvis 2005:25). In some aspects of her world perception (her love for nature and animals, or her experiments in self-portraits) the writer's visual works can be compared to those of the Mexican painter Frida Kahlo.

In the book *Jurgos Ivanauskaitės fenomenas: tarp siurrealizmo ir egzistencializmo* (The Phenomenon of Jurga Ivanauskaitė: Between Surrealism and Existentialism), a textual comparison of the two creators of seemingly different parameters, those of Frida Kahlo and Jurga Ivanauskaitė, is made, keeping in mind that all such comparisons become powerless outside the text. The inspiration for this comparison came from the writer herself, who in the final stage of her life felt an existential affinity with the Mexican painter. This affinity Ivanauskaitė herself might have called the phenomenon of 'synchronicity'. Ivanauskaitė's posthumously published diary, *Overtime*, can be seen as her response to the diary of Frida Kahlo that Ivanauskaitė had ordered in Spanish. She hoped to one day read it in the original, but didn't have enough time left to learn the language.

Why did the artist one day exchange the brush for the pen? Ivanauskaitė recognized that she always felt a deep longing for literature: "My paintings until now have been very literary; I like to include into them not only a brief plot, but the entire narrative as well – the story, the heroes – in order to make them a bit similar to the animated cartoon films where everything is moving from point A to point Z, where it changes from the beginning to the end" (Baranova 2014: 193).

The Lithuanian painter Leonardas Gutauskas also made the switch from painting to literature. He reflected upon it by saying, "In a painting everything is simpler for the reason that when you painted the picture, it dies. You painted for example a tree and it would not be able to grow for thousands of years, nobody would cut it, nobody would feel it. And my angel (as I used to paint) had a raised sword that would not be let down for thousands of years. But literature is constantly boiling, moving, living, changing shapes. It is immortal. Not for the reason that literary work is good. It is in principle immortal all the time, as a geyser" (Baranova 2014: 193).

### Discussion of the Problem

In the book presenting Baltic writers for English-speaking readers, it is stated that Ivanauskaitė is "the most popular contemporary Lithuanian writer reflecting the approximation of 'high' and popular cultures in the post-modern world. Lithuanian literary criticism finds her controversial, as a discoverer of new paths, and as too popular an author. Apart from her literary work, she was also an outstanding personality in public life: a journalist, a public figure (the active member of the Lithuanian Tibet Support Group). During the last years of her life, she spoke openly about the struggle against cancer in a way that was rather unusual in Lithuania" (Daugirdaitė 2009: 109). On the other hand her novel *The Witch and the Rain* (1993) was considered as rather rebellious because it opened up a new perspective on the exploration of feminine sexual passion. "Because of the novel's open eroticism and because Ivanauskaitė depicts a Catholic priest having sex with a young woman, the city council of Vilnius restricted the distribution of the book. The act only ensured its popularity. The novel was seen by some as offensive because it mocked religious and moral sensibilities in a country with a strong Roman Catholic tradition" (Jonušys 2002: 306). In spite of Ivanauskaitė's popularity among readers, she experienced a deep feeling of loneliness, the sense of being neglected by the critics and disdained by contemporary writers. "My writers - colleagues openly demonstrate hostility to me", she said in one of her interviews (Baranova 2014: 504). When she was ill and struggling for life, she went to have surgery in Sweden and was left with one lung and unable to move. The writer Renata Šerelytė, providing criticism of prose from 2005, when Ivanauskaitė's novel *The Fortress of Sleeping Butterflies* was also published, expressed the opinion that she did not understand how it was possible to write about Ivanauskaitė's work at all. Ivanauskaitė read this and wrote to her friend: "I suggest you to also buy the journal *Metai* and read about the prose of 2005. Especially the "piece" by Renata Šerelytė. We both are the enemies of the nation and literature and for this reason it is already time for us to leave for the cemetery" (Urbonaitė 2015: 369).

Seven years after Ivanauskaitė's death, Gabrielė Gailiūtė published results of an inquiry revealing that Ivanauskaitė's prose received the most numerous attention from researchers as is recorded in *The International Research Database "Lituaniстика"* (Gailiūtė 2014: 5). A number of Lithuanian literary critics wrote about her work from different points of view : V. Kubilius (1996, 1999, 2002), V. Daujotytė (2001, 2009, 2001, 2007), J. Sprindytė (2006), I. Gražytė-Maziliauskienė (2004), A. Peluritytė-Tikušienė (2001, 2003, 2003, 2003, 2006, 2006), V. Rubavičius (1979, 1997, 2007), E. Baliutytė (2003), A. Balbierius (1999, 2013), G. Beresnevičius (1999, 2000, 2003), J. Čerškutė (2009), V. Kelertienė (2004, 2006, 2006), G. Kazlauskaitė (2006, 2007), V. Juknaitė (2001, 2005, 2008), V. Jauniškis (1987), L. Jonušys (2013), G. Lučiūnienė (2005), J. Lukšytė (2000, 2000, 2006, 2006) S. Daugirdaitė (1993,1999,2000,2000,2002,2006), A. Danielius (1996), V. Martinkus (2003), K. Navakas (2008), I. Vedrickaitė (2006, 2010, 2010), R. Pociūtė (2006,2009), R. Rudaitytė (2009), A. Ruseckaitė (2005), M. Kvietauskas (2003), L. Tirvaitė (1985,1987,1987,1989), A. Samalavičius (1988), R. Skeivys (2007), K. Urba (2003), etc. On Ivanauskaitė's prose also reflected philosophers: A. Andrijauskas (2004, 2007, 2007, 2010), G. Mažeikis (2012), A. Uždavins (2002). Art critics V. Ryžovaitė (2005), R. Rachlevičiūtė (2011, 2012), K. Stančienė (2011), and J. Sereikaitė (2011) also wrote about her visual creation. The famous poet S. Geda from time to time mentioned her in his published diaries. Why was she so popular? L. Mačianskaitė notices: "J. Ivanauskaitė is called the most provocative Lithuanian writer; however, her innovations are not an end in itself: they are birthed from painful reactions to the poverty of social life and existential hopelessness (as in her collections *The Year of the Lilies of the Valley* (1985) and *How to Raise One's Own Fear* (1989). G. Radvilavičiūtė (the author of *Planned Moments* (2004), *Tonight I Shall Sleep by the Wall* (2010) and the winner of the EU Prize for Literature ), while writing a conceptual introduction to the International literary forum *North Summer*, twice returned to Ivanauskaitė's work by noticing in it the expression of the

creative imagination and revolt. G. Radvilavičiūtė writes: "Ivanauskaitė <...> into the textile of the language weaved on equal rights the songs of Western groups, idyllic and a bit sentimental, the nostalgic, provincial, natural background she had changed into a dynamic, exotic and sinfully seducing town". Philosopher G. Mažeikis notices Ivanauskaitė's courage to balance herself near the limit and to intersect it, and by this to meet the breathing of the possible other world, the courage to open herself to the unknown (Mažeikis 2012: 46).

Ivanauskaitė in 2005 received the highest literary award in Lithuania, the National Prize, for the openness of her creation to the world and for the cultural diversity in *Mandala of Tibet* (2004) and for the sensation of shifting values in her novels. The phenomenon of Ivanauskaitė reveals a new lifestyle characterized by an openness to the world, but not to any specific culture, and the ability to respond to symbols of any culture, be they from the West (surreal art, rock music, modern literature by Rainer Maria Rilke, Franz Kafka, Thomas Mann, Herman Hesse and others), from the 'Near' East, or Russia (Fyodor Dostoyevsky, Aleksandr Blok, Joseph Brodsky, Anna Akhmatova, Marina Tsvetayeva and others), or from the Far East (Japanese engravings, Tibetan Buddhism, etc.), or from the 'third world' countries (Egypt, Peru). Ivanauskaitė's literary breakthrough was writing cosmopolitan literature for both adults in *The Tibetan Mandala* trilogy, in novel *Gone with the Dreams* and essay book *The Alchemy of Travels* and also for children in the book *How Marsis Searched for Happiness on Earth*.

The presumption of our investigation is the following: the features of Ivanauskaitė's literary creation can be understood only by taking into account the interdisciplinary mode of her creativity and her openness to visual culture. Her creation oversteps the distinction "popular or elite" and cannot be reduced to any simple formula. Her works are based on a permanent search for a new creative code. Each book is different from the previous one. Nevertheless, it is possible to distinguish in her works some repeating signs.

### **Surreal and Existential Signs in Pre-Tibetan Creation**

'A writer isn't a writer man; he is a machine-man, and an experimental man <...>' (Deleuze, Guattari 1986: 7), wrote Gilles Deleuze and Felix Guattari in their book *Kafka: Pour une Littérature Mineure* (*Kafka: Toward a Minor Literature*). In both literature and life a writer produces signs. This study aims to decipher and interpret the signs created by Jurga Ivanauskaitė. The signs that were found are classified as surreal or existential. Surreal signs in her creation are expressed in the paradigms of dream, ecstasies, impossible reality, redoubleness, alternative realities. Existential signs reveal themselves as loneliness, fear, estrangement, death, journey, love until death (*meiliamirystė*), suffering, passion for life and the feeling of *numinosum*. These signs are not created by her, but deciphered. As it was asked and answered by Deleuze: "Why has Masoch given his name to a perversion as old as the world? Not because he "suffered" from it, but because he transformed the symptoms" (Deleuze 1995: 143). The symptom of masochism always existed but was unnamed; Masoch just made his diagnosis in his fiction. "Masoch's a great symptomatologist", concludes Deleuze (Deleuze 1995: 142).

In the same manner Ivanauskaitė diagnoses the sources of existential anxiety by giving them literary and visual form. A sense of existential apocalyptic fear, first perceived in the novella *The Year of the Lilies of the Valley*, becomes prominent in the author's second collection of short stories *How to Raise One's Own Fear*. Ivanauskaitė decrypts a wide array of possible signs of fear. The apocalyptic atmosphere is connected to the various unexpected possibilities of an overturned reality: a liquid from the sea sets organic creatures on fire, a red dress sticks to the body and melts it. Like in Sartre's novel *La Nausée* (*Nausea*), the dread of a spontaneous change in the world (being in itself, *en soi*) can be felt (as Sartre wrote, 'it is out of laziness that the world is the same day after day').

Ivanauskaitė grew up in a family with literary traditions. Her grandfather Kostas Korsakas was the director of the Literary Institute of the Lithuanian Academy of Science during the Soviet period and her grandmother Halina Nastopkaitė-Korsakiene wrote reminiscences and short stories. Her mother was an art critique and Ivanauskaitė was expected to become an artist as her father. But unexpectedly in 1982 she started to publish her novels and in 1985 her first book, *The Year of the Lilies of the Valley*, appeared full of surreal signs of impossible, double and alternative realities. In the short story of the same title as the book *The Year of the Lilies of the Valley*, a group of young people is traveling to Pskov and decide to rest in the field of the lilies of the valley as if they were 'flower children'. Pskov was the old Russian town where some esoteric religious experience was practiced in orthodox churches and where some Lithuanian youth searching for an alternative experience used to make pilgrimages to. The young characters in Ivanauskaitė's story discussed spiritual forces,

spirit games and Kant's categorical imperative, Japanese art, the music of Bach, the painting of Chagall, incarnations of Buddha, and Santayana's conception. Suddenly on the road they saw a funeral procession. After visiting Pskov they rested in the suburbs of the town. While they were sleeping, the main narrator noticed: "Suddenly a sharp pain pierced my right hand. I opened my eyes and lifted my head. I was surrounded by nothing else but lilies of the valley. Again, I felt a pain in my right palm. I looked and I was horrified to see two seedlings rising from my hand. Shocked, I jumped to my feet – my friends were bursting with the lilies of the valley. It was as though they were nailed to the floor by delicate, tinkling stems: they couldn't move" (Ivanauskaitė 2013a: 156). The unexpectedness of the plot in these short stories, like a surreal upturn of reality, is very close to Magritte's thought experiments in his painting. Belgian surrealist René Magritte (1898-1967) encouraged creativity of philosophical thought in his painting. Magritte proposed an "optimistic" version of surrealism, based not on the unconsciousness or dreams but on the unexpected overturning of reality. His paintings are examples of the plausible inversions of formal logic and ordinary meaning, leading in each case to a paradox. In the short story *When will Godot Come?* (Ivanauskaitė's first story from this collection), characters from Samuel Beckett's play *Waiting for Godot* meet with Magritte's character – the man with the black coat and hat. The young writer asks a provocative question: What if Godot came at last? What would he be like? Possibly as a character from Magritte's paintings. The paradoxical intrigue of Ivanauskaitė's short stories is based on the interweaving of surreal signs from painting and from literature. The story *The Day That Never Happened* is also based on a rather "Magrittian" question: "What if New Year's Day never came?" formulated in the very beginning of the plot: "Just look at the calendar and you'll see for yourselves. That day simply did not exist!" (Ivanauskaitė 1997d: 193). The story is recalled from a young man's perspective. In the day that never came he met the girl who made him sick with her talks about supreme love. He hated her and scolded her naiveté and left the room but when he returned he found her in blood and disaster. The room was full of feathers. The fragile creature moaning in his bed appeared to have wings and feathers. The narrator glanced at his own hands and noticed that tangled feathers and iridescent dust clung to his blood-covered hands and arms. "I broke her wings <...> sooner or later someone would have done it", concluded the narrator (Ivanauskaitė 1997: 201). The writer in this story turned upside down the expression 'to break the wings', transferring it from language into reality. The question "What if our words unexpectedly turned into real events?" is also very close to Magritte's thought experiments.

Ivanauskaitė's literary work also has a social-historical meaning as in the novel *The Children of the Moon* (1988) she reconstructs the consciousness and lifestyle of certain subcultures (punks, hipsters) of the Lithuanian youth in the 1990s. The writer's choice to include diverse areas of culture into her erudition-enhancing works bears witness to the formation of an unofficial alternative system of self-education among a certain group of young people in the second half of the twentieth century which was not drawn from the contents of official Soviet institutional programs.

The study reveals certain creative parallels between the works of Jack Kerouac, the inspiration behind the beatnik movement, and Ivanauskaitė. The most prominent of these are the interpretation of the phenomenon of travel as a search for God, and turning towards Eastern Buddhism (see *The Dharma Bums* by Kerouac). Unlike Kerouac, who only studied Buddhism in the library, Ivanauskaitė turned this interest to an existential level: she started to travel herself searching for Buddhism in India and Tibet.

In the novel *The Children of the Moon*, the surreal symbols lose their apocalyptic power. The author returns to reality and examines the alienation of urban youth through the lifestyle of the punk and hipster generation. Communication is dominated by monologues; the characters are defined by a search for ecstatic experiences, balancing on the edge of madness, self-destruction, educating oneself in music, and a nomadic lifestyle. As noticed Vytautas Kubilius, "Ivanauskaitė is the only one Lithuanian writer who experienced stronger influence of the hippie movement, which had reached the Baltic countries in the 1960s. Heroes of her novellas, drama and the first novel *The Children of the Moon* (1988) wear their hair in combs, play noisy rock music ("Music was flaying in the room like ball lightning"), inject "intoxicating solution" in their veins, are proud to be "schizophrenic". They gather in the same cafes in Castle street, but do not feel above the aura of the past and culture of Vilnius. "our generation is the generation of cosmopolitans, and I do not consider it a disaster", says one of the heroes of *The Children of the Moon*. They adore the Beatles and Kerouac, read the *Kamasutra*, *The Tibetan Book of the Dead*, Seneca, sometimes Mačernis. But they do not believe in anything. They feel a vicious destructive power hiding in the core of the world which is woken by somebody's strong biological field (in a museum butterflies set themselves free from stands, break the display cases and fly around). Black, scorching, invisible waves, independent of will and consciousness, are moving among people. Heroes of the novel, depressed by universal dissonance ("I feel so bad"), bang their hands against a wall, wishing to crumble into "tiny tiny pieces". The world is irrepressibly falling into an abyss – nuclear death, and we will go off in a moment. Fear of self-destruction ("We are half a kilometre away from the epicentre of

explosion”) undermines any will to arrange one’s life, which will end in a minute” (Kubilius 1997: 503). The heroes from the *The Children of the Moon* are listening to The Beatles or The Doors music, talking about Mikalojus K. Čiurlionis and Salvador Dali art. Ivanauskaitė, in a personal essay written during her travels in India, returns to Dali’s ideas about reincarnation. Some episodes of the dreams in Ivanauskaitė’s early novels could be seen as a pictures painted in the style of Salvador Dali. The girl from the novel *The Children of the Moon* narrates the dream she has every night: she is running as quickly as possible, breaking a dazzling red rush and strikes against her beloved. In the continuing action remains the picture of Salvador Dali, as if it started to move and become a movie: she is slipping from the hands of her beloved, turning into some liquid as transparent as water. “Afterwards everything is poured over by yellow; I disappeared, and the huge dark green bird with shining eyes is landing on your heard. Your body from his weight or stroke started to split; from the top of the heard all your body is cracking and starts to crumble into small shivers, flying in all directions as if by a sling of centrifugal force, without sound, with the yellow shining in gloomy twilight (Ivanauskaitė 2004: 135). Gintautas Mažeikis notices that at the end of the Soviet period the surrealism and figure of Dali appeared as a manifestation of the psychological liberation for alternative youth (Mažeikis 2012:60).

The novel *The Gardens of Hell* (1992) was written between 1989 and 1990, at the time of the collapse of the Soviet system, and was published after the re-establishment of independence. It is a novel of the junction of two eras. Conversely, the novel points to the alienation of members of subcultures as an aspect of historic reality and their inability to find their spiritual bearings in the new reality. Furthermore, a new creative element is introduced as Ivanauskaitė brings the metaphysical collision of good and evil into the literate space. Domantas, the main character, immolates himself believing that he represents the dark forces of the Antichrist and hell. The writer’s preference for fire as a means of self-destruction becomes more pronounced. Having adopted the binding approach of feminist literature to speak openly “about the most intimate things in life”, in her novel *The Gardens of Hell* Ivanauskaitė described the outbursts of woman’s passion, losing senses over a man’s scent, trembling body, emotional ecstasy while making love in a messy hotel or even in the WC or in flying aircraft. Raging, losing one’s mind, being sexual – this is the calling of a modern woman, who freed herself of the bonds of Puritanism. Only love and death exist to rock stars. There are no more essential values which could fill the abyss between these two elements of existence. Heroes of the novel experience the feast of spiritual revival, pasting posters inviting to the first meeting of Sajūdis, however the feast is short. As soon as a handsome singer urns away from one of his four girl-friends, she decides, “Everything’s finished”, “I want to die”. Even in bed with another man and whispering the name of the beloved who deserted her, she wished to destroy herself and vanish irrevocably. As noticed Kubilius, “Ivanauskaitė’s narrative is easy – flowing and impulsive, branching off into dialogue parts – confessions of lovers, like in Kunčinas’ novels. Her word, however, is not so open to the attributes of the outward reality and phraseology of the spoken language. It focuses on inner self-observation, lingers in the space of psychological, philosophical and cultural notions, foreboding that threatening demonic powers are hiding on the other side of visible shapes. Having distributes points of view and the rights of narration to a number of characters, the novelist constructively twists the stories of their lives into a integral compositional ball, maintaining the atmosphere of emotional feeling or even inner identity. Hippie-like emotional exaltations, aesthetized neuroses, psychoses of self-destruction of the characters are pushing their way the scales of the highest tension, and Ivanauskaitė is made to theatricalize the plot situation (incurable cancer, a suicide), to turn to fairly sentimental representation “ (Kubilius 1997: 504-555).

The novel *The Witch and the Rain*, (1993) brought the author international acclaim. It is translated and published into Latvian (1994, 2013b), Russian (1995), Estonian (1997b), German (2002d, 2004), Croatian (2003e), Swedish (2005c), Czech (2006c), Italian (2013c), Slovenian (2014) languages. The novel has a contemporary point of departure, but it also flashes back hundred of years to stories old by medieval witch (personage M.V.) and by Mary Magdalene. The various aspects of a wild, bewitching, disastrous woman’s love have a persuasive intensity, expressed in an accomplished literary text. An innovative linkage of time dimensions, removed from each other by centuries but united by the aspect of female metaphysical longing for love, connects the novel with the symbolism of archetypes as defined by Carl Jung. The novel reveals that the modern woman is unable to perceive herself as dissociated from the past that archetypically inserts itself into the history of man-woman relations. Jung’s assumption of *Unus mundus* (Latin for ‘one world’) holds the novel together. All three stories of *The Witch and the Rain* take place in a vertical timeline and stand out as fundamental, archetypical points that define female metaphysical longing. The literary critique Laimantas Jonušys noticed a paradox in this novel: “in the narrative of the story the men appear like gods and the women are submissive to them, but on the psychological level as a matter of fact important are only women, the men as personages for the author appear only as objects, as a point of measure. In this sense one can understand and the image of Christ – the author hardly could be blamed for profanation.

Of course, the Christ created by Ivanauskaitė could appear as too human, doubtful, sad, but, it seem more provocative appears the image of Mary Magdalene, connected with the topic of this book – novel about the women's love, about bewitched, intoxicating, killing passion, about woman's sexuality" (Йонушис 1995: 15-16). In this novel woman is no just a 'chalice of sin', deserving condemnation; she searches through love for her place in God and finds it. The Apostle Peter drives Mary Magdalene away from Christ: "You are a woman, and they are not worthy of living". According the Old Testament a libertine should be stoned to death. Jesus, however, washes her feet and says: "only love will make you free." Kubilius notices, that this is the novel's main idea, developed in several planes of the plot: woman's right to God's mercy is not less than of a priest or a monk who are also sinners. "The romantically fatal passion to the only man is accompanied here by light-minded intercourse with any stranger and lesbian caress, while the despair of a deserted woman – by nightmarish hallucinations and visions of mediaeval horrors a if transferred from Hieronymus Bosch's painting" (Kubilius 1997: 505)

Ivanauskaitė, in her writing, visual art, and life style, had broken the established rules of provincial culture based on the rural experience. She turned against the stream and, following the prose of Saulius Tomas Kondrotas and Ričardas Gavelis, created the path of Lithuanian literature "from the city". She turned the masculine sexually-free style of life expressed in Henry Miller's or Jack Kerouac's novels upside down and wrote Agnija's Magic in a similar style but from the woman's perspective. The novel Agnija's Magic (1995) sees a different trajectory of self-consciousness in the main female character Agnija. Unlike the women of *The Witch and the Rain* who die for love, Agnija has a more 'masculine' attitude that manifests itself in her choice of leading an active and erotically unrestrained lifestyle. Agnija is Amsterdam-bound as a photographer for her first Western exhibition. As a character, she is quite self-aware and ironic, endowing herself with a multitude of names; e.g. Agnija-the-Naïve, Agnija-the Cynic, Agnija-the Sexpot, Agnija-the Philosopher. On the cover of the first edition of the novel, a fragment of the Belgian surrealist Paul Delvaux's picture *The Man in the Street* (1940) was reproduced. The man in Delvaux's picture is very similar to Magritte's heroes with black official suits, but absent in the chosen fragment. Only women are left. In her poem dedicated to Delvaux, Ivanauskaitė wrote: "The nudes, astonished by the whiteness of their naked bodies/In their glassy eyes/the luminary of madness/the moon is reflecting" (Ivanauskaitė 2007a: 101)

Ivanauskaitė in the novels *The Witch and the Rain* and *Agnija's Magic* tried to grasp the natural essence of woman. One can find here many erotic scenes, oriental motifs, travelling adventures and wonderful pictorial scenes. Speedy rhythm of the life, strained mentality, longing to have and to give oneself up and at the same time - torturing question: is it possible to feel stable grounds of faith? As Vytautas Rubavičius noticed, Ivanauskaitė in the novel *Agnija's Magic* "presented the most comprehensive literary phenomenology of a body; to discuss it with the Jungian metaphors of collective unconsciousness and the echo of Henry Miller's works would be very helpful" (Rubavičius 2007: 96).

This novel also reveals the author's interest in the mystical forces of the world. Violeta Kelertas interprets the novel as a case of postcolonial literature. She notices in it two incompatible desires: a sexual quest and an exalted spiritual state, combined with an attraction to the exotic, which express themselves in strange paradoxes: in trying out a new landscape, in trying out a new man, in experiencing a new country, Agnija attempts to experience a new belief system. These incompatibilities result in the novel's peculiar mixing of genres – the travelogue turns into an erotic text, after that – to a religious one, "non-traditional for the Western reader. For example, at the end of *Agnija's Magic* there is almost an appendix – a description of Buddhist theology and a list of rules to live by according to this faith. This is proselytizing, in a way. It invites followers. Back in Vilnius, Agnija has been interested in black magic and voodoo, but after traveling to India, she succumbs to the influence of Buddhism" (Kelertas 2006: 453). Finally, *Agnija's Magic* differs from the other three pre-Tibetan novels due to its self-liberating nature. It has no apocalyptic finale of self-destruction; no-one dies or commits suicides. In this novel Ivanauskaitė begins drawing the symbols of her travels into her literary space. On the other hand, the horrors from Hieronymus Bosch's painting are deep inside Agnija's consciousness. She compared her impression of Amsterdam with visions from a Boschian picture: "The Boschian Hell, whose horrible wheels are turning in the narrow street of the old medieval town, full of flowers, the presentiments of death, music, trivial laughter and desire" (Ivanauskaitė 2006a: 14).

Even if Ivanauskaitė had stopped writing, as she said she would to fully embrace Buddhism, her two collections of short stories (*The Year of the Lilies of the Valley*, *How to Raise One's Own Fear*) and her four novels (*The Children of the Moon*, *The Gardens of Hell*, *The Witch and the Rain*, *Agnija's Magic*) would have already made their mark on Lithuanian literature as modern classics of urban literature that range from the surreal to the existential.

### The 'Tibetan' Works: a Journey towards Oneself,

In 1994 Ivanauskaitė took her first trip to India and studied Buddhism at Dharamsala, gaining the impetus to start a new page in her literary work. These works covers Ivanauskaitė's creation between 1996 and 2000: three essay books (Tibet in Exile, 1996; A Journey to Shambala, 1997; The Lost Promised Land, 1999), one novel (Gone with the Dreams, 2000) and the collection of poems The Dance in the Desert (2004).

One can propose several conceptual explanations for Ivanauskaitė's phenomenon of travel: situational-social, psychological, fate-related, ecumenical, and anthropological-genetic. We think that the most accurate is the cultural-spiritual explanation which emphasizes the journey as a certain quest for spiritual experience and the opportunity to construct oneself in the face of otherness. The otherness enchants the writer's imagination with the opportunity for manifold – spiritual, existential and even physical – renewal.

Ivanauskaitė's book *Tibet in Exile* (1996) the first book of *The Tibetan Mandala*, reflects the author's desire to understand the concept symbolism of a foreign culture and to erase the habit of creative writing. To a large extent it reminds the reader of a beginner's guide to Buddhism and provides information on the various aspects of Tibetan culture, religion and history. However, the suppressed creative spiritual intensity of the writer breaks through as reflective essayist prose. As notices Howard Jarvis "Until the first of these, absolutely no books on Tibet had been available in the Lithuanian language. A collection of traveler's tales and in sights into religion, political situation and everyday reality of Tibetans living in exile in Northern India, *Tibet in Exile* delves into the soul of one of the world's most profoundly spiritual societies. It even has a personal foreword by the Dalai Lama, whom Ivanauskaitė has met on several occasions. Lithuanian readers seem to relate well with the subject of Tibet. The idea of a distant mountain kingdom chimes in with the romantic ideals of the Lithuanian character, while its fate of invasion and exile connects directly with Lithuanian memories of occupation and harsh, often religious persecution "(Jarvis 2005: 24-25).

In the second book from the journey *The Journey to Shambhala*, (1997) this reflective essayist prose reaches its top form. In this book the experiences of the narrator can be viewed from several different angles. On the one hand, she is a proactive person who travels, changes her location, and makes unexpected decisions. On the other hand, she is a seeker who is still searching for the secret codes of this culture and attempts to penetrate its depth both in theory and in practice, even if it puts her at risk. An erudite, the writer wants to become an expert of her chosen path, she studies the plentiful sources that explain and interpret the tradition in question. Third, she is who she is – an individual, a psychological human being. Her subconscious works like an engine and sends her unexpected, at times traumatizing, impressions and signals. Fourth, she is a writer, who not only describes the characteristics of this culture, but also how it affects the seeker herself. Fifth, she constantly withdraws and sees reality from the sidelines, as she would take in a visual art or, more accurately, a film. In this way she activates her thoughts and perceives the situation and herself in a greater depth and from a different angle than it would be possible from the confines of everyday domestic life. All these interwoven aspects and the tensions that arise from their connections are presented in an intriguing and challenging narrative which seems to be written by the author herself, or by the journey as a unique fragment of life. In reality, the narrator wants to be objective, to see the world without the veil of illusion and understand everything the way it is; she is aware of all other possible variations and dispersions of the ego. In a way, *The Journey to Shambhala* is the most convincing of the author's works. As notices Regina Rudaitytė, "Symbolically, the writer's journey to Shambhala becomes an inward journey, a sacred journey to one's own hidden self in search of spirituality with the aim of changing oneself and assuming a different, according to Ivanauskaitė, a superior identity. This change presupposes an absolute refusal from egotism, the annihilation of one's ego and the "obliteration of personal history" as a means of attaining happiness and bliss, nirvana "So what if my ego quizzically whispers to me that I used to like French cooking or Chinese delicacies, vintage red wine, and that I used to hobnob with refined aesthetes? But then and there I felt a void, I felt that something was always missing, while here and now, cutting the bird-like toenails from Lama's unwashed feet I am feeling happy. Maybe this is the bliss which only the obliteration of personal history can bring about. Here nobody is interested either in my native country or city, language, profession, social position, either in my family, age or my real name. I am simply Nobody having come from the Nowhere country where time should probably be named Never" (Rudaitytė 2009: 119).

In this book Ivanauskaitė describes many of her personal experiments with Buddhist spiritual practice and insights, both inspiring and tormenting. She felt intense inner conflict between her Western background and her very new experiences of living and being instructed by lamas in Ladakh and Nepal. As recollected Jarvis: "even when it is time to leave, the conflict between physical and spiritual is still there: "Upon leaving Ladakh, I feel as if I have to be separated from a person whom I



love madly. I want to say farewell by making some tangible gesture, so I can feel a physical closeness. But what I embrace, clasp to my breast, kiss – the mountains, the deserts, the air, the light, the silence? (Jarvis 2005: 25).

A reference guide to authors and their work *Baltic Writers: Estonia, Latvia, Lithuania* provides an information, that: “during the period of the National Revival, Ivanauskaitė turned to Christianity, but later became a Buddhist, and in 1994, on the eve of a journey to India, she declared she would stop writing fiction, as it was not compatible with Buddhist practice. However, at the end of her life she returned both to her literary work, and to Christianity’ (Daugirdaite 2009: 110).

First of all, Ivanauskaitė returned to literary writing not at the end of her life, but at the very beginning of her first journey; during her travels she was sending essays that were published in the newspaper *Lietuvos Rytas*. While traveling she also finished her pre-Tibetan book *Agnija’s Magic* in 1995 and in 1996 she published her essays in a book *Tibet in Exile*. The Dalai Lama wrote the preface for this book. During her travels she also published her greatest collection of essays, *Journey to Shambala* (1997), based on her experience traveling in India, and the third book from the trilogy *The Lost Promised Land* (1999) about her trip to Tibet.. Even her later novel *Gone with the Dreams* (2000) was based on her traveling experience, as well as her later published collection of poetry *The Dance in the Desert* (2004). In the book, the author reveals the various possible trajectories of metaphysical longing by way of short poetic meditations. These miniatures are included in the book *The Lost Promised Land* as ostensible manuscripts of Pema Deĉen.. The author also plays the role of literary critic and interpreter by telling the reader what she thinks of her own poetry. Rudaitytė notices that when traveling, “she <...> questions the poststructuralist view of the world created by discourse which, however, according to Ivanauskaitė, ‘is not the sole reality but only a narrow subjective space created by ourselves.’” (Rudaitytė 2009: 119). Of course she questions, but on the other hand, it is not very difficult to notice that Ivanauskaitė never stopped creating this discourse regardless of her declarations.

Secondly, the provided research revealed that Ivanauskaitė never exchanged Christianity for Buddhism or the other way round. Though during the period of the fight for national independence she was christened by Monsignor Kazimieras Vasiliauskas, Ivanauskaitė was not a zealous church visitor. In video material she confesses that she experienced transcendence somewhere else, for example in the forest, because in the church it used to disappear suddenly. She read the Bible, the Koran and the basics of the Kabbalah and explored the tradition of Buddhism. In all religions she sought out the mystic intrigue of the secret signs and numinosum. On the one hand, the writer was intrigued by ‘witchery’ and magic while on the other hand, her search was fuelled by a strong longing for the sacred. She could discern some signs of sanctity in pagan culture (the culture of stones, for example). The two-fold tension between believing and not believing is also reflected in the diary *Overtime*, in which visions and a mystic experience of closeness with God are replaced with doubts and scepticism. The fundamental intrigue of the phenomenon of Ivanauskaitė is the fact that she never fully identified herself with any world-view or conception and, regardless of or because of this, felt a constant metaphysical longing for uninterested love, sanctity, absolute gentleness, unity, and perfection. In search for numinosum Jung as well as Thomas Merton and Master Eckhart were her spiritual leaders.

### **The ‘Post-Tibetan’ Works: Social Motifs**

When Ivanauskaitė returned to Lithuania after her travels, she experienced a deep feeling of loss. “I suffer from an overwhelming feeling of nostalgia”, she says. “I can’t even watch images of Tibet or the Himalayas on television, when my friends call to tell me they’re on. My heart would be broken”, recalls Jarvis (Jarvis 2005: 24). But she never abandoned her work and continued writing. During the post-Tibetan period (2000-2007), she published a collection of essays based on her trips to other countries, *The Alchemy of Travels*, and the interview book *The Gentle Interrogations*, (2005), as well as two more novels: *Placebo* (2003) and *The Fortress of Sleeping Butterflies* (2005), a fairy-tale for children *How Marsis Searched for Happiness on Earth*, succeeded to finish her last poetry collection *Ode to Joy* and left unfinished her diary *Overtime*, published by her mother Ingrida Korsakaitė after the writer’s death, without any mention of her traveling experience in India and Tibet.

In the collection of essays *The Alchemy of Travels* (2003) she proves her essay-writing skills yet again. She uses irony, self-irony, wit and laconic speech; she discusses issues in a seemingly care-free, playful way, but manages to reach their roots. Following Jung’s example, she calls this writing method ‘synchronicity’, but it can also be seen as a certain phenomenology.

The first post-Tibetan novel *Placebo* (2003) meets the reader as a detective story: the main heroine is killed or kills herself on the first page. However this does not preclude her from telling stories and making comments from beyond the grave, from a peculiar intermediate state of death, by flying and looking around. She is surprised by her own death, asking questions: "how long had it been already? A day? A week? A month? A year? A decade?" (Ivanauskaitė 2004:11). On the other hand this book, as noticed Gintaras Beresnevičius, is almost a documentary historical book in which one recognizes all the scandals, misunderstandings, pleasures and enjoyments, follies and realities of the Lithuanian in the beginning of 21<sup>st</sup> century. Novel *Placebo* looks like a literary parody of consumerism. The tone of the narrative is ironic. Five different planes are interwoven in the novel. The first is the afterlife plane of the fortune-teller Julija. The second plane of realistic everyday life is split into two parts: the introspective musings of the characters, which, although characteristic of Ivanauskaitė, is less apparent in this novel than in her pre-Tibetan works, and the social space, which is an entirely new element. There is also the cosmic reality of reincarnations, thoughts, and experiences of the cat Bastëtė, as if from the novel *Gone with the Dreams*. Finally, the fifth plane is the dimension of the Centre or that of the creators of the *Placebo*. In this novel *Placebo* is a substitute for reality. The underlying intellectual intrigue of the novel is that we exist not in reality but in its substitute the qualities of which are created, changed or otherwise controlled by some more powerful force, the so-called Centre. Julija "was lured to *Placebo* five years ago not by an insatiable thirst for money, but by a passionate wish to do battle with the wealthy, self-satisfied and satiated. An antipathy towards politicians and anarchist beliefs meant any form of government was inherently bad. Julija confirmed to herself that she had an inborn, perhaps karmic, genetic predisposition toward those types who are perched at the top of the social pyramid, deciding the fate of the people and country. Politics always (except for the brief "Singing Revolution" interlude) seemed to her as the same old dreadful and cynical farce" (Ivanauskaitė 2004e: 12). Here Ivanauskaitė once again approaches the concept of the world-reformer, conceived by Ričardas Gavelis in his novel *Vilniaus džiazas* (*Jazz of Vilnius*). As notices Gintaras Beresnevičius "It is a post-modern novel with an underlying metaphysical implications; however, it is also a continuation of perhaps the last 15 years of Lithuanian novels, because here I can see both *Glisono kilpa* and *Tūla*, (novels by Jurgis Kunčinas – J.B.) and, of course *Vilniaus pokeris* with "Them" by Ričardas Gavelis" (Beresnevičius 2004: 9).

In 2005 Ivanauskaitė published her second and last post-Tibetan novel, *The Fortress of Sleeping Butterflies* (2005) in which she intertwines some major themes: human trafficking, social help and the age of the apocalypse. The novel breaks down into two narrative planes, the internal and the external. The internal plane is moderated by the introspective thoughts of the main character Monika. The external narrative is centred upon her social project of resocialization of former prostitutes. Trafficking in women ("butterflies" as they are called by country folk) is described in the novel without any didactic shade, thought with sympathy and empathy, questioning the role of the "victim". As noticed Giedrė Kazlauskaitė "an important social (as well as existential) theme dictates the free, evangelically humane declaration of the authors positions, to turn back and look at man in dirt and trouble, misery, and the senselessness of life" (Kazlauskaitė 2006: 86).

This narrative was used by Lithuanian film director Algimantas Puipa, who directed a film of the same name *The Fortress of Sleeping Butterflies* (2012) in which the internal plane was suspended and Apocalypse disappeared. Meanwhile, the apocalyptic atmosphere of this internal plane in Ivanauskaitė's novel brings it close to the archetypical symbols in the film *Melancholia* (2011) directed by Lars von Trier. The main protagonist Monika constantly feels the pulsation of Murderer Star. Unlike her last two novels, *Gone with the Dreams* and *Placebo*, this novel is devoid of the afterlife and cosmic dimensions. But cosmos have turned into the threat of the Apocalypse. The primary reality unrolls in Monika's consciousness. Monika reflects: "Galaxies will start decomposing, and the degenerated stars will be bumping into each other, while their corpses and their broken pieces will be falling into black holes. Scientists make predictions that these developments will only start in approximately sixty billion years from now. But maybe scientists made an in significant error, and the Degradation era is starting tonight. And maybe the Suicide Star that I can observe so clearly is the first herald of these Apocalyptic developments" (Ivanauskaitė 2011b: 69). These are the moods and the possible thought of Justine from *Melancholy* by von Trier. Ivanauskaitė wrote it in 2005. Trier created the movie in 2011. It is obvious that the novel written by Ivanauskaitė he never read. Ivanauskaitė if were alive would have called this parallels following Carl G.Jung as synchronicity. As notices Kazlauskaitė, reflecting upon Monika's inner states in the novel *The Fortress of Sleeping Butterflies* "the symptoms of a woman suffering from depression are exact and characteristic, the psychological nuances are accurate (Kazlauskaitė 2006: 87).

Ivanauskaitė's last book *Ode to Joy* (2007), coincided with the author's death – it appeared the day she died. It is a collection of poems written over a significant period of time, and only seven of those poems are new. In a way, it closes a cycle of her creation, as Ivanauskaitė began her creative path with poems published in the magazine *Moksleivis* when she was at

school. Having returned to poetry, the writer felt the fragile nature of a poem and made an effort not to violate it: she did not overdo it or push it too far. Her poems are of moderate length; they are neither overburdened with metaphors nor pretentious. Had she not exchanged poetry for prose, and continued writing poems as she did at school, Ivanauskaitė might have made her mark in our cultural context as a Lithuanian Wislawa Szymborska: the poetry of both is moderate, ironic, intellectual, and capable of describing fundamental issues (or creating existential symbols) in a concise form. Ivanauskaitė simply did not write enough poetry. In her poem *Morning. Another Incarnation* she wrote: "Having risen from the dead / I hang around the seashore, /gather/pocketfuls of seashells/and listen, oh I listen/to the humming of the sea waves/until I've forgotten/the drumming of earth/onto my coffin lid" (Ivanauskaitė 2010: 2). The translator of her poems into English Paul Perry reflects: "What I feel when I read her work is the presence of a passionate and longing voice, one which has a seductive intimacy to it, a voice which will tell the hard truths, but which has an ironic twist to it also.<...>In it, she faces her own mortality with a steadfast stare and a brave wit and irony" (Perry 2010: xi-xii).

However, the format of a poem was too constricting for her, as was that of the novella. Considering the scale of her passion for life, the small genres could only be temporary endeavors. They were too delicate. Thus Ivanauskaitė published only two books of poetry, two of short stories, one collection of interviews, and two books for children. Yet she left seven novels, only the first two of which were a little shorter. The other five are books of impressive length. Vytautas Kubilius was right when he said that Ivanauskaitė was a writer of fervent spiritual tension.

In one of her interviews she formulated the two-sidedness of their creation: "Writing and painting are two different things. Writing is a very exhausting and tormenting activity: while writing you constantly feel tension, you feel how your unconsciousness is boiling, working. During the nights when I am writing a novel I see texts coming to me in my dreams. A terribly tiresome and exhausting process: all day you are writing and afterwards all night you are further laying out the words. Pictures for me are pure meditation. After meditation you quietly fall asleep. All day you are painting, but when your work is finished – that's all. The burden falls off your shoulders and nothing else is tormenting you (Baranova 2014: 194).

## Literature

- Baranova, J. (2014) *Jurgos Ivanauskaitės fenomenas: tarp siurrealizmo ir egzistencializmo (The Phenomenon of Jurga Ivanauskaitė: Between Surrealism and Existentialism)* Vilnius: Tyto alba. In Lithuanian.
- Beresnevičius, G. (2004). *The Dawn of Ersatz Civilisation*. *The Vilnius Review*. *New Writing from Lithuania*, no.15, pp. 7-10.
- Deleuze, G.,Guattari, F. (1986) *Kafka: Towards a Minor Literature*. Mineapolis, London: University of Minnesota Press.
- Deleuze, G. (1995) *Negotiations*. New York etc.: Columbia University Press.
- Ivanauskaitė, J. (1985) *Pakalnučių metai (The Year of the Lilies of the Valley): [short stories]*. Vilnius: Vaga. In Lithuanian.
- Ivanauskaitė, J. (1988) *Mėnulio vaikai (The Children of the Moon): [novel]*. Vilnius: Vaga. In Lithuanian ,
- Ivanauskaitė, J. (1989) *Kaip užsiauginti baimę (How to Raise One's Own Fear): [short stories and novellas]*. Vilnius: Vaga. In Lithuanian.
- Ivanauskaitė, J. (1991) *Stebuklinga spanguolė (The Miraculous Cranberry): [fairy tale]*. Vilnius: Vyturys. In Lithuanian.
- Ivanauskaitė, J. (1992) *Pragaro sodai (The Gardens of Hell): [novel]*. Kaunas: Nemunas. In Lithuanian.
- Ivanauskaitė, J. (1993) *Ragana ir lietus (The Witch and the Rain): [novel]*. Vilnius: Vaga,. In Lithuanian.
- Ivanauskaitė, J.(1995) *Agnijos magija (Agnija's Magic): [novel]*. Vilnius: Vaga,. In Lithuanian.
- Ivanauskaitė, J.(1996) *Ištremtas Tibetas (Tibet in Exile): [essays]*. Vilnius: Tyto alba,.
- Ivanauskaitė, J. (1997a) *Kelionė į Šambalą (The Journey to Shambhala): [essays]*. Vilnius: Tyto alba. In Lithuanian.
- Ivanauskaitė, J (1997b) *Nöid ja vihm, (The Witch and the Rain )*. Tallinn: Olion. Translated into Estonian. by Mihkel Loodus.

- Ivanauskaitė, J. (1997c) Mikor jөн el Godot? Polisz, nr.29, pp.40-44. Translated into Hungarian by Bän Péter.
- Ivanauskaitė J. (1997d) The Day That Never Happened. In Lithuania in Her Own Words. An Anthology of Contemporary Lithuanian Writing. Ed.Laima Sruoginis. Vilnius: Tyto alba, pp.193-201. Translated into Lithuanian by Laima Sruoginis.
- Ivanauskaitė, J (1998) Ceļojums uz Šambalu (The Journey to Shambhala). Rīgā: Jumava, , Translated. to Latvian by Talrids Rullis.
- Ivanauskaitė, J. (1999a) Prarasta pažadētoji zemē (The Lost Promised Land): [essays on Tibet].Vilnius: Tyto alba. In Lithuanian.
- Ivanauskaitė, J. (1999b) Agnijas magija (Agnija's Magic). Rīga: Avots. Translated into Latvian by Talrids Rullis.
- Ivanauskaitė, J. (2000a) Sapnų nublokšti (Gone with the Dreams): [novel]. Vilnius: Tyto alba. In Lithuanian.
- Ivanauskaitė, J (2000b) Zaudētā Apsolītā zeme (The Lost Promised Land). Rīga: Jumava. Translated. into Latvian by Talrids Rullis.
- Ivanauskaitė, J.(2001a) Trimdā aizdzītā Tibeta (The Tibetan Mandala), Rīga: Jumava. Translated into Latvian by Talrids Rullis.
- Ivanauskaitė, J. (2001b) Czarownica i deszcz (The Witch and the Rain): (excerpt from novel). In Sen Mendoga. Antologija literatury litewskiej lat dziewięćdziesiątych. Warszawa: Książka i wiedza, pp.257-272. Translated. into Polish by Alicje Rybalko.
- Ivanauskaitė, J. (2002a) Ragana ir lietus (The Witch and the Rain): [novel]. Vilnius: Tyto alba. In Lithuanian.
- Ivanauskaitė, J. (2002b) A Few Thoughts on Spiritual Life Since Lithuanian Independence. A Personal Essay. In: The Earth Remains: An Anthology of Contemporary Lithuanian Prose.Vilnius: Tyto Alba, pp. 308-312. Translated into English by Laima Sruoginis.
- Ivanauskaitė, J. (2002c) Gone with the Dreams (excerpt from novel). In: The Earth Remains: An Anthology of Contemporary Lithuanian Prose. Vilnius: Tyto Alba, pp.313-331. Translated into English by Laima Sruoginis.
- Ivanauskaitė, J (2002d) Die Regenhexe (The Witch and the Rain). Deutsche Erstausg, München: Deutscher Taschenbuch Verl. Translated. into German by Markus Roduner.
- Ivanauskaitė, J (2002e) Das haus ausserhalb der stadt. Meldung über Gespluster. Erzählungen aus Litauen. Salzburg: Otto Müller verlag, pp. 176-182 .
- Ivanauskaitė, J. (2003a) Pakalnučių metai (The Year of the Lilies of the Valley): [short stories].Vilnius: Tyto alba. In Lithuanian.
- Ivanauskaitė, J. (2003b) Kelionių alchemija (The Alchemy of Travels): [essays]. Vilnius: Tyto alba. In Lithuanian.
- Ivanauskaitė J. (2003c) L'année des muguets. In Des ames dans le brouillard. Anthologie de nouvelles lituaniennes contemporaines. Presses universitaires de Caen, pp.155-167. Translated into French by Ugnė Karvelis.
- Ivanauskaitė, J.(2003d) Placebas (Placebo): [novel]. Vilnius: Tyto alba. In Lithuanian.
- Ivanauskaitė, J (2003e) Vještica i kiša (The Witch and the Rain). Zagreb: Profil international. Translated into Croatian by Loreta Vasilj.
- Ivanauskaitė, J. (2004a) Mėnulių vaikai (The Children of the Moon): [novel]. Vilnius: Tyto alba. In Lithuanian
- Ivanauskaitė, J. (2004b) Kaip Marsis žemėje laimės ieškojo (How Marsis Searched for Happiness on Earth): [fairy-tale]. Vilnius: Tyto alba. In Lithuanian.
- Ivanauskaitė, J. (2004c) Šokis dykumoje (The Dance in the Desert): [poems]. Vilnius: Tyto alba. In Lithuanian.
- Ivanauskaitė, J. (2004d) Tibeto mandala (The Tibetan Mandala): [trilogy]. Vilnius: Tyto alba. In Lithuanian.

- Ivanauskaitė, J.(2004e) Placebo (excerpt from novel). The Vilnius Review. New Writing from Lithuania, spring, no.15, pp.11-19. Translated into English by Darius Ross.
- Ivanauskaitė J. (2004f) Slik. Posldni vlak Ivanje. In Brauko Mirjana. Antologija litovske. Kratke price. Zagreb: Biblioteka živi jezici, pp. 166-191. In Croatian.
- Ivanauskaitė, J. (2005a) Miegiančių drugelių tvirtovė (The Fortress of Sleeping Butterflies): [novel]. Vilnius: Tyto alba. In Lithuanian.
- Ivanauskaitė, J (2005b) Placebo. München: Deutscher Taschenbuch Verlag. Translated into German by Markus Roduner.
- Ivanauskaitė, J (2005c) Häxan och regent, (The Witch and the Rain). Stockholm: Tranan. Translated into Swedish by Jonas Öhman.
- Ivanauskaitė, J (2005d) Švelnūs tardymai (The Gentle Interrogations). Vilnius : Tyto alba. In Lithuanian.
- Ivanauskaitė, J.(2006a) Agnijos magija (Agnija's Magic): [novel]. Vilnius: Tyto alba. In Lithuanian.
- Ivanauskaitė, J (2006b) Sapņiem līdzī: [Gone with the Dreams]. Rīga, Dienas Grāmata, . Translated into Latvian by Talrids Rullis.
- Ivanauskaitė, J. (2006c) Čarodějnice a déšt (The Witch and the Rain). Praha: Mezera. Translated into Czech by Gabriela Šroubková.
- Ivanauskaitė, J.(2007a) Odė džiaugsmui (Ode to Joy): [poems]. Vilnius: Tyto alba In Lithuanian. .
- Ivanauskaitė, J.(2007b) Viršvalandžiai (Overtime): [essays]. Vilnius: Tyto alba. In Lithuanian.
- Ivanauskaitė, J.(2007c) Nežaiskite su mėnuliu! (Do Not Play with a Moon!): [plays]. Vilnius: Tyto alba. In Lithuanian.
- Ivanauskaitė, J. (2008) Citanje proznog štiva. In Forum. Zagreb. Travanj-lipanj, 4-6, pp.486-493. In Croatian.
- Ivanauskaitė, J. (2009) Kaip užsiauginti baimę (How to Raise One's Own Fear): [short stories and novellas]. Vilnius: Tyto alba. In Lithuanian.
- Ivanauskaitė, J. (2010a) Pragaro sodai (The Gardens of Hell): [novel]. Vilnius: Tyto alba. In Lithuanian.
- Ivanauskaitė, J.(2010b) 108 Moons. The Selected Poems of Jurga Ivanauskaitė, Dublin: The Workshop Press. Translated into English by Paul Perry and Rūta Suchodolskytė.
- Ivanauskaitė, J.(2010c) In aereo. Alla Fiera del libro. Avventura notturna. Circolo vizioso. In Poetare e pensare in forma di parole. Mappa della poesia lituana del terzo Novocento. Poeti degli anni sessanta. numero secondo, aprile, maggio, giugno, pp. 172-189. A cura di Pietro U.Dini.
- Ivanauskaitė, J.(2011a) Angelo rūbas (The Angel's Dress). Vilnius: Tyto alba. In Lithuanian.
- Ivanauskaitė, J.(2011b) The Fortress of Sleeping Butterflies (excerpt from novel). In No Men, No Cry. Contemporary Lithuanian Women's Prose. Chicago: International Cultural Programme Centre, pp. 63-75. Translated into English by Milda Dyke.
- Ivanauskaitė, J. (2013a) Year of the Lily of the Valley. In The Dedalus Book of Lithuanian Literature. Ed.by A.Samalavičius. London: Dedalus, pp.146- 157.
- Ivanauskaitė, J.(1994, 2013b) Ragana un lietus, (The Witch and the Rain). Rīga: Preses names. Translated. into Latvian by Talrids Rullis..
- Ivanauskaitė, J. (2013c) La strega e la pioggia (The Witch and the Rain). Novi Ligure: Edizioni Joker. Translated into Italian by Pietro U. Dini.
- Ivanauskaitė, J. (2014a) Stebuklinga spanguolė (The Miraculous Cranberry): [fairy tale]. Vilnius: Tyto alba. In Lithuanian.

- Ivanauskaitė, J. (2014b) *Čarovnica i dež* (The Witch and the Rain). Maribor: Pivec . Translated into Slovenian by Klemen Pisk.
- Иванаускайте, Ю. (2002f) Путешествие в Шамбалу (The Journey to Shambhala) Киев: София; Москва: ИД Гелиос. Translated. into Russian by Natalija Vorobjova. In Russian.
- Иванаускайте Ю. (1983) Год ландышей. Литва Литературная, no.5, сс. 76-85. Перевод Анны Герасимовой. In Russian.
- Иванаускайте, Ю. (1992) Иванова ночь. Вильнюс.Vilnius, no.5-6, 100-107. Перевод Аллы Асовской. In Russian.
- Иванаускайте, Ю. (1995) Ведьма и дождь. Вильнюс.Vilnius, no.1-2, сс. 17-67. Перевод Екатерины Йонайтене. In Russian.
- Иванаускайте, Ю. (1995) Ведьма и дождь. Вильнюс.Vilnius, no.3-4, сс. 16-90. Перевод Екатерины Йонайтене. In Russian.
- Иванаускайте, Ю. (1995) Ведьма и дождь. Вильнюс.Vilnius, no.5-6, сс. 22-93. Перевод Екатерины Йонайтене. In Russian.
- Jarvis, H. (2000). A Colourful Bird in a Pale Land : why Jurga Ivanauskaitė's Books are Crying out for Translation. Central Europe Review, vol 2, <http://www.ce-review.org/00/27/jarvis27.html>. Retrieved 2015-03-10.,
- Jarvis, H.(2005) Drawn to the Mystical World. Vilnius Now! June, pp.24-25.
- Daugirdaitė, S.(2009) Ivanauskaitė Jurga. In Baltic Writers. Estonia, Latvia, Lithuania. A Reference Guide to Authors and Their Works. Vilnius: Institute of Lithuanian literature and folklore, pp.109-110.
- Kazlauskaitė G. (2006) Let Sleeping Butterflies Lie. The Vilnius Review. New Writings from Lithuania. Spring, no.19, pp. 86-88.
- Mažeikis, G. (2012) Išlaisvinantis paribių sąmoningumas Jurgos Ivanauskaitės ir Ričardo Gavelio romanuose. Inter-studia humanitatis, no. 13. pp.45-66.
- Kelertas, V. (2006) Foot-Loose and Fancy-Free The Postcolonial Lithuanian Encounters Europe. In Baltic Postcolonialism. Ed.V.Kelertas. Amsterdam and New York: Rodopi, pp. 451-459.
- Kubilius (1997) The Integration of Split Literature. In Lithuanian Literature. Vilnius: Vaga., pp. 477-508.
- Urbonaitė, A (2015) Mano didžioji nuodėmė , žurnalistika (My Greatest Sin, Journalism) Vilnius: Alma littera.
- Meuris, J. (1994) René Magritte 1898 - 1967. Koln: Benedikt Taschen.
- Radvilavičiūtė, G. (2007) Šiaurės vasara. Literatūra – tarp fakto ir išmonės. (The North Summer. Literature - Between Fact and Wit) Tarptautinis šiuolaikinės literatūros forumas. Programa. 2007 rugpjūčio 24-26. Vilnius/ Jurbarkas.
- Radvilavičiūtė, G. (2008) Šiaurės vasara. Rašytojas ir maištas. (The North Summer. Writer and Revolt) Tarptautinis šiuolaikinės literatūros forumas. Programa. 2008 birželio 12-15. Vilnius/ Jurbarkas.
- Rubavičius V. (2007) Kaip sugrįžti į kūną?(How to Return to One's Body? ) In Rubavičius, V. Neįvardijamos laisvės ženklas. Vilnius: LRSL, pp. 295-300.
- Rudaitytė, R. (2009) In Search of The Self: Jurga Ivanauskaite's Journey to Shambhala. Literatūra. 2009, no.51 (4), pp. 114-120.
- Йонушис Л (1995) Самобытный роман о женской страсти. Вильнюс.Vilnius, no. 1-2, сс. 14-16. In Russian.

---

## Women's Political Participation in some of the Western Balkan Countries

**Abdula Azizi**

Associate Professor,

Southeast European University,

a.azizi@seeu.edu.mk

### Abstract

*In the early 1990s, Balkan countries in the course of the great regime transformation have articulated and introduced a number of democratic changes and institutions. Most of them also provided at least a formal legal framework for a fair and equal representation for all citizens in political process. Nevertheless, almost twenty years later, many countries are still facing the phenomenon of gender inequality both in society and economy and in the political sphere, particularly in the political representative bodies on various levels. The theme of this research consists of the analysis of social and systemic factors that affect women's participation in political life. The purpose of this research is to analyze and compare the representation of women in the political representative bodies. This research is focused on the representation of women in political representative bodies, analyzing a wider Balkan region – Albania, Kosovo, Macedonia, Bosnia and Serbia. For purposes of this paper, was made a survey of citizens in Macedonia, which included questions that citizens have expressed their stance over gender equality, the quota system and the effectiveness of mechanisms for gender equality. Finally, I draw some conclusions and make some suggestions in order to encourage research and other activities related to gender policies.*

**Keywords:** Women's political participation, quota system

### 1. Introduction

To make an assessment of gender situation in a certain country, it is necessary both to understand the social and political contexts (nationally and regionally), as well as to understand the changes of the 'gender policy field' itself. Once those contexts and dynamics are captured, opportunities and constraints become clearer, and the development of gender equality could be approached as a complex social learning and interactive process which creates profound social change. That is the basis for the overall assessment of the gender equality situation in the countries and strategies and policies which have been applied. That is also the starting point for the recommendations and context sensitive definition of future priorities.<sup>1</sup>

In order to understand the problem of equal representation in a transitional democracy, it is necessary to analyze the laws of some Balkan countries. Gender Equality Laws provide an important basis for ensuring women's rights and political participation in the Balkan region. During the transition period, Gender Equality Laws have been put in place in many these countries. At this stage, emphasis needs to be put on harmonizing legislation and related procedures and institutions to ensure the implementation of gender equality laws.

Since the Convention on the Elimination of All Forms of Discrimination against Women (CEDAW)<sup>2</sup> adopted by the UN General Assembly in December 1979, it has been ratified by 186 countries. The CEDAW recommendations also require that member states sensitize private enterprises, trade unions and political parties to promote women in the decision-making process. CEDAW Article 7 obliges states parties to 'take all appropriate measures to eliminate discrimination against women in political and public life and to ensure that they enjoy equality with men in political and public life'.<sup>3</sup> It refers to the exercise of political power, in particular the exercise of legislative, judicial, executive and administrative powers. The term covers all aspects of public administration and the formulation and implementation of policy at the international, national, regional and local levels. The concept also includes many aspects of civil society, including public boards and

---

<sup>1</sup> Gender country profile for Bosnia and Herzegovina (Lot 1 COM), Project No. 2013/333302 /1, European Commission, 2014, p.13

<sup>2</sup> For the full text of the convention see <http://www2.ohchr.org/english/law/cedaw.htm>.

<sup>3</sup> States that 'Parties shall take all appropriate measures to eliminate discrimination against women in political and public life of the country and, in particular, shall ensure that women, on equal terms with men, have the right: (a) To vote in all elections and public referenda and to be eligible for election to all publicly elected bodies; (b) To participate in the formulation of government policies and the implementation thereof and to hold public office and perform all public functions at all levels of government; (c) To participate in non-governmental organizations and associations concerned with the public and political life of the country.'

local councils and the activities of organizations such as political parties, trade unions, professional or industry associations, civil society organizations, community-based organizations and other organizations concerned with public and political life.<sup>1</sup> A number of countries in the Balkan region have developed successful strategies to increase women's political participation. Gender quotas are intended to guarantee a particular level of female representation in Parliament (Dahlerup & Freidenvall, 2005). Gender quotas ensure that women constitute a specific number or percentage of the members of a body, be it a candidate list, a parliamentary assembly, a committee or the government. There are three types of gender quotas: reserved seats, legal quotas, and voluntary/party quotas (Norris & Krook, 2011). Reserved seats involve the government mandating that a certain number of seats in Parliament be held for women; legal quotas are "mandatory provisions that apply to all parties" (Franceschet & Krook, 2008) and finally, voluntary gender quotas are "introduced solely by the individual political parties and not required by national legal rules".

## 2. Assessment of overall gender equality in Western Balkan Countries

The policy developments of the Western Balkan countries are very controversial and contradictory. On the one hand, there is formal acceptance of very advanced policies, legal changes and projects which should have an impact on the laws and institutions. Yet, these activities usually end in action plans, reports and/or conclusions which are not implemented; hence, they do not produce any actual change. On the other hand, the patriarchal system of values and conservative Government measures (introduction of religious education in the formal education system, campaigns against abortion, support for having three, four and more children and decreasing the support for early childhood care) pose serious obstacles to achieving gender equality.

Laws guaranteeing equal opportunities for women, in line with European Standards and norms have been adopted, however, the level of implementation of legislative measures is perceived as very low and women continue to face disparities in terms of jobs, wages and political representation. The legal frameworks related to gender equality are in place, but on the other hand there is quite time remaining in order to transpose these laws into the daily lives of the citizens. The implementation of the adopted legislation is slow and inconsistent. There is a stark contrast between stated goals and their actual implementation (Spehar, 166).

### 2.1 Women's Political Participation in Albania

In the first pluralistic parliament in 1991 only 3.6% were women and in the parliament that followed only 2.8% were women.<sup>2</sup> Although the Parliamentary Elections 2005 produced one of the largest numbers of women participating in elections as MP candidates, at the end of elections, Albania produced one of the lowest numbers of women MP's in Europe and of women in public administration. Women in the Parliament make only a little over 7% of the seats. In a survey of Inter-parliamentary Union of women's representation in elected positions, Albania is in 116-position out of 187 countries, and the last if compared with other South European countries.<sup>3</sup> In the local elections in 2007, only 9 were elected for mayoral/head of commune. In top decision-making positions, women are not well represented and as of 2008, there are only two female Cabinet Minister. Advances have been made – for example, the Speaker of the House, the Public Prosecutor and High Court Judges Chiefs are women.<sup>4</sup> Additionally, many political parties have instituted quotas within their general assemblies.

Recent legislative victories in Albania, in particular the inclusion of quotas for elected and appointed positions in the law "On Gender Equality in Society" (July 2008) and the revised Electoral Code (December 2008), have led to an increase in Albanian women's political participation at the national level. The 2009 parliamentary elections saw a doubling of the number of women in parliament: from 7% in 2005 to 16.4% in 2009. Despite these gains, women's full and equal participation in decision-making in the public arena continues to be restricted by pervasive stereotypes and discriminatory practices – particularly at the local level.

The 2009 national election was the first to take place after the passage of the law, which instituted a quota for women's participation in political life. It stated that at least 30 % of appointed positions should be filled by the underrepresented sex

<sup>1</sup> UN Committee for the Elimination of Discrimination of Women (CEDAW) Rec. No. 23, 16<sup>th</sup> Session, 1997

<sup>2</sup> Research project: "Albania in Transition: Elite's Role and Perspective" by Kosta Barjaba, NATO scholarship holder (individual), 1996-1998.

<sup>3</sup> Report on Women in Politics for the situation on 1 January 2008 prepared by Inter-Parliamentary Union and the United Nations Division for the Advancement of Women on the occasion of the 52<sup>nd</sup> session of the UN Commission on the Status of Women.

<sup>4</sup> 5 out of 15 members of High Court Judges are female. <http://www.gjykataelarte.gov.al/anetaret.htm>



(i.e. women). It also stated that 30 % of all candidates put forward in national and local elections should be from the under-represented sex. In that election, 23 women deputies were elected, which was 16.4% of the total 140 seats in the Assembly of the Republic of Albania. The "Law on Gender Equality in Society" (2008) and the new Electoral Code (2008) were important steps forward in terms of women's representation, but did not result in a critical mass of women entering parliament.

This global trend has yet to be felt in Albania, where women's role in public life remains largely unrecognized, and women's full and equal participation in decision-making continues to be restricted due to pervasive stereotypes and discriminatory practices.

## 2.2 Women's Political Participation in Kosovo

The Constitution of Kosovo names gender equality as a fundamental value and participation is one of its more evident manifestations. Since 2002, following a decision by the Central Elections Commission, all political parties in Kosovo are obliged to have women represented at one third of candidates in their election lists. As a result, 30 % of members of parliament in the Assembly of Kosovo are women. This fact alone ranks Kosovo very high internationally regarding participation of women in politics.

The Law on Gender Equality, approved in 2004, calls for "equal opportunities for both female and male participation in the political, economical, social, cultural and other fields of social life." The Assembly of Kosovo, civil service, Judicial Council, and Constitutional Court, among others, must ensure that the principles of gender equality are respected. The topics addressed in the Law on Gender Equality are extensive, leading some to see it more as a wish list than an implementable law.

The Law considers gender equality requirements to have been met when women's participation reaches 40% within all institutions. The Law also stipulates that gender equality must be considered in the naming of institutions, public undertakings, and roads. It requires all public and private institutions to provide equal employment opportunities for women and men. Following extensive advocacy on behalf of women's rights activists, the Law also established the Agency for Gender Equality within the Prime Minister's Office, theoretically at the highest possible level. The Agency for Gender Equality (AGE) was created in 2005 to implement and monitor the implementation of the Law on Gender Equality, promote policies towards gender equality, propose research on gender equality issues, and work to increase gender equality awareness, among other tasks.<sup>1</sup>

Women in decision-making positions in Kosovo (2011): ministers (10%), deputy prime ministers (33%), Prime minister's office (31%), foreign missions (18%), Kosovo Police Service employees 13.8 %, all institutions (36%).<sup>2</sup>

The quota enabled women to secure 30% of the seats in the municipal assemblies and later in the Parliament.<sup>3</sup> The positive impact of this measure on the "increased representation and meaningful participation of women in national and local governance" was evident.<sup>4</sup> Women secured only 8% of the seats in the first municipal elections in 2000, but the quota guaranteed 30 % in future elections.<sup>5</sup> Eventually, the Law on Gender Equality (2004) would call for women and men to each hold at least 40 % of positions at all decision-making levels. In 2007, 43% of the women in Parliament were elected by name recognition and 37% in 2010.<sup>6</sup> That most decisions continued to be made within political parties and parties tended to be led by men limited women's "meaningful" participation in decision-making processes.<sup>7</sup> As political parties in Kosovo remain rather hierarchical, men do not necessarily have greater decision-making power than women if they do not sit at the top of the party.

<sup>1</sup> For more see at: Kosovo Women's Network, Facts & Fables: A collection of stories about the implementation of United Nations Security Council Resolution 1325 on Women, Peace, and Security in Kosovo, Prishtina, 2011, p.65

<sup>2</sup> KWN interview with Ariana Qosaj-Mustafa, Advisor to President Jahjaga, Prishtina, 15 July 2011.

<sup>3</sup> OHCHR, "High Commissioner's Strategic Management Plan 2010-2011," at: <http://www.ohchr.org/Documents/Press/SMP2010-2011.pdf>.

<sup>4</sup> KWN interview with Arbena Kuriu, Program Officer, OHCHR, Prishtina, 27 July 2011

<sup>5</sup> Law on Gender Equality, Art. 6, according to Luljeta Domaniku, Legal Councilor for Gender Equality of the Ombudsperson Institution (KWN interview, Prishtina, 14 October 2011).

<sup>6</sup> KWN interview with EULEX representatives, Prishtina, 13 July 2011.

<sup>7</sup> UN Secretary-General, indicators 3a, 4, and 5a.

### 2.3 Women's Political Participation in Macedonia

2.4 Gender equality is guaranteed by the Constitution of Macedonia (Article 9). From the group of laws on equality, equal opportunities law of men and women have a special role<sup>1</sup>, which aims to ensure the implementation of "equal opportunity" for men and women in several areas (Article 2). Also, a provision on gender equality also occurs in other laws: the Law on labor relations<sup>2</sup>, the law on political parties<sup>3</sup>, Law on Election of Deputies<sup>4</sup>, Law on Local Elections<sup>5</sup> and the Law on Prevention and Protection from Discrimination.

Towards the incorporation of the concept of gender equality in the each ministry are appointed coordinators for equal opportunities for men and women, in the Assembly of RM there is a Commission for equal opportunities for men and women, while in the municipalities are formed committees for equal opportunities for men and women. Macedonian government have also developed and set up national machineries for advancement of women. The Unit for Gender Equality has been set up by the government in 1997 within the frame of the Ministry of Labour and Social Policy (MLSP) with the purpose to influence the advancement of women's position in conformity with the international documents. Ten Commissions on Gender Equality within the ten Local Municipal Councils in Macedonia were established in 2000. In 2003 the Women's MP Club was formed, which works on promotion of gender equality in general and on harmonization with EU gender equality standards as well as representing a service for elected women in the Parliament.

Macedonia marks the progress in the past on the results of balanced participation of men and women in power and decision-making process. In the first period of implementation of the National Plan for Gender Equality (1997-2007), was marked gradual advancement of women's representation in power. As an illustration, it is worth comparing the results obtained in this direction. As a result of the parliamentary election of 27 April 2014 for the period 2014-2018 the number of women MPs in Parliament had exceeded the 30%, whereas in the government, women as heads of ministries were represented by 17.6%. Mayors were only 3%, whereas members of the municipal assembly were 21%.<sup>6</sup> However, although the number of councilor's municipality has increased several times, is still great disproportion between men and women. All this is partly as a result of unfair access by political parties, and partly as a result of women's traditional political inactivity. Thus a greater number of municipalities was not achieved a minimum 30% quota of women in representative lists.<sup>7</sup>

Laws guaranteeing equal opportunities for women, in line with European standards and norms, have been adopted, however, the level of implementation of legislative measures is perceived as very low and women continue to face disparities in terms of jobs, wages and political representation. Within the executive branch, the participation of women is low, as a result of lack of affirmative action.

### 2.5 Women's Political Participation in Bosnia and Herzegovina(BH)

The BH case shows that closed lists are problematic for the empowerment of women and their participation in politics. Likewise, open lists can lead to a drastic reduction in women's representation when the country lacks an enabling environment for women candidates. Women in BH are still largely excluded from decision making positions. In 2013 ministries of all nine ministries of BH were men. However, women are equally represented as deputy ministers, as men, which is a good indicator of possible change. However, the percentage of women in legislative and executive authorities at all levels remains unsatisfactory, although the situation is much more favourable in the Parliamentary Assembly of BH. In 2011, only 19% of women were represented in the Parliament, 21.4% in the House of Representatives and 13.3% in the House of the Peoples. In the 2008 elections the electorate included 49% women and 51% men; registered candidates consisted of 64.8% of men and 35.2% of women, whereas among the elected officials 85% were men and only 15% were women. The percentage of women elected as mayors was in 2012 only 7.3%. In 2012 out of 54 positions there were only 12 women (22.2%) female ambassadors and general consuls in the diplomatic/consular offices. However, women make 51% of civil servants in the institutions. Available data on the ratio of men to women employed in public administration in BH shows approximately the same ratio amongst civil servants in both Republika Srpska and the Federation of BH. Within

<sup>1</sup> Official Journal of Macedonia, No.66/06 and 117/09

<sup>2</sup> Official Journal of Macedonia, No.60/2005

<sup>3</sup> Official Journal of Macedonia, No.76/2004

<sup>4</sup> Official Journal of Macedonia, No.42/2002 and 46/2004

<sup>5</sup> Official Journal of Macedonia, No. 46/96, 12/2003, 35/2004, 52/2004 and 60/2004

<sup>6</sup> Source: National action for gender equality 2007-2012, Skopje, May 2007.

<sup>7</sup> OSCE-PARD Survey on the Implementation of the Process of Decentralization, July 2006, p.15.

the judiciary of BH it is evident that women outnumber men amongst court personnel. The percentage for women ranged from 43.1% in the Court, to 67.5% in the municipal courts. Election law requires a 30% quota of female representation in elected bodies (Women and Men in BiH 2013, p.49).

The major lesson learned from the Bosnian experience is that if a quota system is introduced, it must be accompanied by other measures such as support to women in election campaigns, education of women on how to lead their campaigns, support to media to pay more attention to women candidates, and voter education.

## 2.6 Women's Political Participation in Serbia

Around 2% of women were elected in the first multiparty elections for the Serbian Parliament in 1992. Under the regime of President Slobodan Milosevic, the largest proportion of women in parliament was 5%. Following the democratic changes of 2000 and subsequent elections, the representation of women stands at around 11% and 6% in the national parliament and the local assemblies, respectively (Mrsević, 2004). In September 2004, the quota system, specifying that 30% of the under-represented gender must be included on candidate lists, was introduced nationwide. As a result, women won 25% of the seats in local assemblies.

Serbia aimed to increase the percentage of women within Parliament by a substantial percentage, from roughly 22% to 33%, by the end of the 2012 election cycle. This was attempted through an obligatory quota, which required Serbia's political parties to place a woman in every third position on their electoral lists. This work served as a witness to the ultimate success of this gender equality goal, in an attempt to evaluate its potential application to other settings. For the larger part of the last election cycle (Vojvodic, 2012). Serbia stood in a relatively good position both regionally and globally. From 2008-2012, Serbia ranked 56<sup>th</sup> out of approximately 150 ranked countries on the Inter-Parliamentary Union's list of percentages of women in national legislatures.<sup>1</sup>

In terms of the 5 other former republics of Yugoslavia, Serbia was also positioned relatively well in this group. According to data from the Inter-Parliamentary Union, Serbia was ahead of Montenegro where women only make up 12% of Parliament and Bosnia and Herzegovina where women make up a close 21% of Parliament. At that point, Slovenia's Parliament was laudably composed of 32% of women, Croatia's was composed of a close 23%, and FYROM's Parliament was composed of 31% women. It is clear that the region has done quite well in terms of this indicator so Serbia had tough competition within the former Yugoslavia. The picture is more favorable for Serbia outside of the "Yugosphere". Albania, a Balkan neighbor, also lagged behind Serbia with 16% of Parliament being comprised of women. Greece had 19% women in Parliament; Bulgaria had 22%.

Quotas have so far been used in Serbia to increase women's representation in political party leadership and on parties' lists of electoral candidates. Quotas may be the only way to ensure a degree of representation for women in countries where the rate of participation is very low.

In elections held in 16 March 2014, women were represented 34.4% from the total number of deputies.<sup>2</sup>

**Table 1 woman in politics**

<i>Country</i>	<i>Women in parliaments</i>	<i>Women Ministerial position</i>
Serbia	22%	15%
Albania	15.7%	6.7%
Macedonia	30.9%	13.6%
Bosnia and Herzegovina	21.4%	6.3%
Montenegro	12.3%	5.9%

Source: Women in politics 2012: Situation on 1 January 2012, UN WOMEN.

<sup>1</sup> Inter Parliamentary Union, Women in Parliaments, 2012.

<sup>2</sup> Source: parlament.gov.sr/narodna-skupstina/narodna-skupstina-u-brojkama/polna-struktura.1731.html

### 3. Survey results

For purposes of this paper, in February 2015 was made a survey of citizens in Macedonia, which included questions that citizens have expressed their stance over gender equality.

**Table 2 the citizens' opinion on the gender issues**

Question	Answer		
	Yes	No	No Answer
1. Do you think that the quota system for the under-represented gender is politically justified?	62%	27%	11%
2. Do you think it with the census defined in the quota can be achieved gender equality in political life?	19%	80%	1%
3. The control mechanisms for gender equal opportunities, are effective or not in political life??	29%	48%	33%

### 4. Conclusions

Gender equality in reality did not correspond to the legal framework. Even the small attention given to the process of overcoming stereotypes of gender relations in society as well as in the decision making process did not meet the expectations.

Large deficits have been indicated in equality in real economic life, production and creativity, employment, and specific branches such as media, diplomacy, management, etc.

At the doorstep of the European Union, all Balkan countries face the challenge of equal opportunities in the field of politics and in the decision-making process in particular. In the process of analysis, it has been largely proven that women are underrepresented in important decision making areas.

Though legal instruments and institutional mechanisms to promote women's political participation have been established, more work needs to be done to fine-tune them and put laws into practice. In many cases, poor implementation of gender equality laws, including the absence of provision for work/life balance, account for the low participation of women in political processes. Greater participation of women in parliament and other decision-making bodies, together with their strong representation in civil society organizations, are needed to ensure government accountability to gender equality legislation. Women in political parties face a number of challenges. For example, they are often not promoted to higher party positions, they do not have access to funding, and they don't attract the attention of the media, or have the social support to promote themselves for office. Some reasons for their exclusion include: the patriarchal tradition, caring and domestic duties that are considered to be women's duties, as well as the psychological and physical demands of switching focus from motherhood.

The challenge is to build a political culture, particularly during election campaigns, to promote women alongside men candidates. The key is to ensure that party lists respect quota systems when they are in place, and go beyond the minimum possible representation of women required by law. It is therefore important to encourage parties to place women candidates high on party lists and in responsible and accountable positions.

Also, on the other hand, the EU during the process of approximation of the Western Balkan countries must continue to recommends the Western Balkan states that:

- the issue of women's rights should be at the center of negotiations in all negotiating chapters with candidate countries of the Western Balkans;
- to absorb EU funds should always targeted projects dealing with the promotion of women's rights, including monitoring mechanisms;
- should support activities aimed at strengthening the position of women in society; including positive discrimination measures;
- combating all forms of discrimination in the workplace, including gender discrimination in relation to recruitment, promotion and salaries should be imperative;

- should continue without exception, the punishment of human trafficking in the Balkans;
- It's important to improve the situation of women in rural areas, especially vis-à-vis the habits and discriminatory stereotypes.

### Bibliography

1. Barjaba, K., "Albania in Transition: Elite's Role and Perspective", 1996-1998.
2. Dahlerup, D., & Freidenvall, L.(2005). Quotas as a 'Fast Track' to Equal Representation for Women. *International Feminist Journal of Politics*, 7(1), 26-48.
3. Franceschet, S., & Krook, M.L.(2008). Measuring the Impact of Quotas on Women's Substantive Representation: Towards a Conceptual Framework. Paper presented at the annual meeting of the American Political Science Association (APSA), Boston, MA, p.21
4. Mrsević, Z.(2004). Institute for Social Science Research-Belgrade, A paper presented at the International Institute for Democracy and Electoral Assistance (IDEA)/CEE Network for Gender Issues Conference The Implementation of Quotas: European Experiences Budapest, Hungary, 22–23 October 2004, p.2
5. Mulliqi, Sh. (2011). Kosovo Women's Network, Facts & Fables: A collection of stories about the implementation of United Nations Security Council Resolution 1325 on Women, Peace, and Security in Kosovo, Prishtina
6. Norris, P., & Krook, M.L.(2011). Gender Equality in Elected Office: A Six-Step Action Plan. Vienna, Austria: Organization of Security and Cooperation in Europe (OSCE)/ Office for Democratic Institutions and Human Rights (ODIHR), p.28
7. OSCE-PARD Survey on the Implementation of the Process of Decentralization, July 2006, p.15.
8. Spehar, A., The EU as a Gender Policy Promoter in Western Balkans "Facade Democracies" pp.165-166. For more see at: [http://cerqu.gu.se/digitalAssets/1333/1333608\\_andrea-spehar.pdf](http://cerqu.gu.se/digitalAssets/1333/1333608_andrea-spehar.pdf)
9. Vojvodić, A.(2012). Women in Politics: Progress and Impact in the Serbian Context, October, p.5
10. Women and Men in BiH 2013, Agency for Statistics, Sarajevo, 2013, p.49

---

## Influence of Third Opinion Leaders on Decision Making Quality: a Case on Financial Decision Making

**Nik Maheran Nik Muhammad, DBA**

Universiti Malaysia Kelantan

nikmaheran@umk.edu.my

**Rikinorhakis Ridwan**

Universiti Malaysia Kelantan

rikiuitm08@gmail.com

### Abstract

*Many top leaders nowadays are relying on external parties to get ideas and information for more effective and quality decision-making. For certain leaders, the power of thinking partners is the factor of success in their decision making process. This study therefore aimed to identify the influence of third opinion leaders in enhancing the relationship between leadership styles and financial decision-making quality. Based on the initial work of Joni (2004) and Path-Goal theory, with 211 usable respondents using hierarchical regression analysis, shows that the quality of financial decision is significant and positively related to leadership behavior. Third opinion's mind and third opinion's relationship act as pure moderator, while third opinion's focus was found to be a quasi-moderator. For theoretical implication, the findings suggest that the inclusion of the moderating variable will further enhance the understanding of the differential impact of leadership style under various contexts of decision-making situation, in this case, the third opinion. For future research, it is recommended that differences relation to leadership behavior should be studied more extensively to reach various kinds of comparative conclusions.*

**Keywords:** leadership styles, Third opinion, Path-Goal theory

### Introduction

Today's work environment is becoming increasingly turbulent and therefore leaders must take the responsibility to make good or quality decisions in order to ensure the survival of the organization (Moss and Kinnear, 2007). Managers often have incomplete information and insufficient time to make decisions, and by delaying decisions they can negatively affect the organization. When making decisions, some researchers suggest that managers should try to gather information from many levels of the organization or outside of the organization from various sources or parties. They must remember that the source of information that they get may not be reliable or accurate and they have to keep in mind that an incorrect decision could have an impact on the organization and understand that changes in the work environment can affect their decisions. These researchers also believe that the most important thing for managers is to take responsibility for the results and not blame others when things go wrong because by pointing fingers at others will only erode the trust and respect for them (Kaval, and Voyten, 2006).

According to Flynn, Goldsmith, and Eastman (1996), there are two types of related parties in the process of opinion leaders which are "information seekers" (i.e. a person or a leader looking for advice or suggestions from others), and the second is "the informant" (i.e. a person or leader who provides advice or opinions). Thus, previous studies have explored the factors that affect the ability of a person to influence others was conducted in the work environment such as the advice network (Gibbons, 2004) and also in non-work environment (Oygard, 2003).

Findings from other research on opinion leaders were used by Chaney (2001) in marketing decision making and have been used to test the customer decision-making style where it focused on the quality of a decision made by an individual (Scheufele, 1999) and also study the effectiveness of an organization (Emden, Calantone and droge, 2006). At the same

time, (Roger and Kincaid, 1981) have argued that opinion leaders have been assessed as “an individual who often influences the attitude and behavior of others”. This individual has been identified as a “provider of information and advises other members”. Therefore, Weimann et al. (2007) explain that opinion leaders are more preferable to influence the quality of the decision using mouth-to-mouth communication.

Decisions and leadership are compatible pairs. Great leaders seem to make more than their share of good results. Drucker (2001) said, “The decision is of specific tasks for an executive, how to make a decision is regarded as the biggest single contributor to successful leadership”. Great leaders and great results essentially are interrelated. One solution is to share and delegate decision-making throughout the organization (Confida, 2004) through opinion and third opinion leadership.

Third opinion is a leadership style adopted from the idea of Joni (2004) which relies on outsider’s opinion in influencing the decision-making process. Joni (2004) has proposed three characteristics of third opinion which is being used in this study. There are third opinion’s mind: people with knowledge and high thinking level; third opinion’s relationship: people with personal trust and networking; and third opinion’s focus: people who have idea, creativity and innovativeness. This research advocates that third opinion is contingent upon the relationship between leader’s behavior initiated from Path-goal theory by House and Mitchell (1974) and Situational theory by Hersey and Blanchard (1977). Leaders’ behavior therefore is conceptualized based on four dimensions namely directive behavior, supportive behavior, participative behavior and achievement-oriented behavior.

The quality of financial decisions is important for the leaders and also for their organizations. Effective decision leaders are committed to the ultimate goal of achieving high quality decision (Kouzes and Posner, 2007). According to Carr and Brower (2000), making decisions in good order is the result of quality decision-making processes. He also argued that one who successfully sets up strategy decisions arising from decision processes is one in which individuals and organizations find and process information efficiently in varying situations. There are various types of financial decisions which are related to financial investment decisions, in connection with the acquisition of assets related to business expansions and the management of loans and credit in connection with mergers and acquisitions and others.

#### Background of the study

Initial studies on opinion leadership begins from the work of Lazarsfeld, Berelson, and Gaudet, in which the first was founded by Katz and Lazarsfeld (1955), and then was reviewed by Rogers (2003), Cross, Laseter, Parker and Velasquez (2006) and Weimann, Tustin, Vuuren and Joubert (2007). The majority of work on opinion leadership focuses on motivating opinion leaders (Chan and Mirsa, 1990), measurement of current issues (Childers, 1986; Flynn, Goldsmith and Eastman 1994), and the results of opinion leadership (Bloch, 1986). However, this concept requires a consensus definition if one wants to use it effectively.

Rogers (2003) stated that an opinion leader is “an individual who gives the number of unequal influence on the decisions made by other people”. Understanding leadership as an influence of personal opinion is clear, concise and compact, and if one looks at the work done since that time, one can see that it is all based on a preliminary study before (Kyun, 2007). Joni (2004) then introduced the term “third opinion leadership” that indicates many top leaders nowadays are relying on external parties to get ideas in a more effective and quality decision-making.

Economic growth and strong financial condition is an important part of the corporate world. With technological advancements, market integration and competitive markets have increased the demand to produce good and correct decisions. Consequently, Malaysia, like the rest of the world has doubled its efforts to transform the economy to achieve higher value and added growth. Therefore, more efficient mechanisms are required to ensure successful transformations. However, something happened in the corporate sector in Malaysia in 2001 where due to the resignation of Tun Daim Zainuddin (a very influential financial adviser to Malaysia’s prime minister in 2001, Tun Dr Mahathir) from the political world has caused organizations of Renong-UEM and Malaysian Airlines System (MAS) to experience a severe fall (Asia Times, 2001). In this regard, the government had to take over Renong-UEM, Malaysia Airlines System (MAS), Malaysia Resource Corp Bhd (MRCB) and Kuala Lumpur light rail operators PUTRA and STAR, in an effort to reduce the growing debt levels and normalize the situation which had weakened due to the fall in stocks. This shows that the importance role of external consultants or better known as “third opinion” that is experienced in the business world, particularly in the areas of finance, in influencing the decision to strengthen organizational performance is very important. In addition, a similar problem affected

to Bank Islam Malaysia Berhad (BIMB) which suffered significant losses and many small shipping companies listed on Bursa Malaysia (The Star, 2005) as well as many small and medium sized firms that could not endure stability in the market.

Following these incidents, many researchers have agreed that “the performance of each company depends entirely on the management of organizational leadership. In short, it is associated with a person’s ability to manage an organization and how they get ideas and information from outside parties to make wise decisions” (The Star, 2005). Therefore, the right decision together with external information obtained from experts allows the company to take advantage of the decision-making errors that could lead to a decline and whose continued weakness would affect the income of the organization in the future. A good decision can lead to success which helps strengthen organizational performance. On the other hand, a bad decision can lead to bankruptcy. Goleman (2001) also believes that outside intervention in making quality financial decisions can help a person deal with and improve critical situations that are sensitive in nature.

There are various types of third opinion such as thinking partners, public opinion and others. For presidents or higher ranking leaders, they will use the power of public opinion to support their decision making. Kernell (2007) argued that the president who appeals to the public would be effective if the president “communicates on a regular basis as his top priority to citizens” and citizens respond by making good changes in public opinion. For certain financial leaders, the power of thinking partners will also be the factor of success in making decisions (Hoffberg and Korver, 2006). They have to make wise choices of their third opinion to help them determine certain decisions. Best “thinking partners” must have a high potential and be able to think beyond boundaries (Joni, 2004).

Rogers and Agarwala-Rogers (1976) have classified that opinion leaders can be regarded as informal leaders. Besides having a high technical ability, others are attracted to these opinion leaders because they “can be trusted and will lead the norms of a group” (Leonard-Barton and Kraus, 1985). Joni (2004) who pioneered the concept of a third opinion recognized that the external environment is important in creating better outcomes for decision making. Her case studies conducted in the United States prove that the hierarchy of leaders in the organizations (from the lower leaders to senior leaders) needs information from outside the organization in making the best decisions.

### **Motivation of the study**

According to Rost (1993), leadership is not only the work of a single person; rather it is a “collaborative endeavor”, which is a relationship between leaders, followers or expert opinion that contributes to the decision making process. Tuckman and Jensen (1977) discovered a progression of development in external people’s interaction that when completed adequately, led to higher quality decisions (Kerr and Tindale, 2004). Hinsz and Nickell (2004) stated that “group decision-making is always advisable” or “group decision making is always bad” than making decisions alone. But, when it comes to financial decisions, Sutter (2005) claimed that the decision in a group or the involvement of other parties namely third opinion is better than individual decisions. .

However, studies on third opinion are still in its infancy stage since the introduction of the term by Joni (2004). Earlier studies on opinion leadership are only related to consumer (Weimann, et al., 2007) and marketing decisions (Yuen, 2007). To the knowledge of the researcher, none has been found to relate opinion leadership to financial decision making such as assets acquisitions or investment decisions. This gap has motivated the researcher to investigate the contribution of third opinion leadership to financial decision quality in relation to leadership style possessed by decision makers. Hence, the purpose of the study is to determine whether or not third opinion leaders influence the quality of financial decisions and the characteristics of third opinion chosen by the decision makers.

### **Literature Review**

Decision-making is a key aspect of leadership in any organization, whether public or private. Leadership plays a tremendous role in the processes and applications of decision-making. Quality of decision is important for the leaders and also for the organization. Effective decision leaders are committed to ultimate goal of achieving high quality decisions (Kouzes and Posner, 2007). According to Carr and Brower (2000), make a decision in good order are the result of a quality decision-making process. He also argued that one who successfully set up strategy decision arising from decision process is one in which individuals and organizations find and process information efficiently in varying situations.



In making a good financial decisions, as well as quality, Simon (1987) pointed out that, decision makers must know more about the industry, social and business environment in which they work. Quality of financial decision is a decision that has to meet organizational objectives and create a positive impact on decision-makers. A decision quality depends on the decision making process in which a decision maker organized, prioritized, aims and filled with a variety of information (Simon 1987). The way successful leaders approach the decision-making process changes as he or she moves up in the organization (Brousseau, Driver, Hourihan and Larsson, 2006). Thus, some leaders make decision based on their own judgment and some will refer to other people's opinion before further judgment is made. Leadership style that seeks and gives opinion from and to others is called opinion leadership style.

### Leader's Behavioral Style

There are four common leadership behaviors which have been introduced by House and Mitchell (1974) and House (1977) from Path-Goal Theory: directive, supportive, participative, and achievement-oriented styles. It is assumed that leaders are flexible, and that the same leader can display any or all of these behaviours depending on the situation. (1) Directive Behavior Style is behavior of a direct order to subordinates where the leader or manager lets subordinates know what they should be doing, making the schedule work, coordinating the work, providing specific mentoring, and provide an explanation of policies, laws, regulations and work procedures. (2) Supportive Behavior Style is the behavior that is directly related to the satisfaction of needs and interests of subordinates as displaying concern for the welfare of subordinates, creating friendship and support in a good working environment (House and Mitchell, 1974) (3) Participative Behavior Style is the behavior directly influencing the direction of encouraging subordinates to make decisions about the operations of the work unit, negotiating with subordinates and taking their opinions and suggestions when making decisions. It has also been referred to as collective decision-making or at least shared influence in decision making by the superiors and their employees (Koopman and Wierdsma, 1998; Yukl, 2002). (4) Achievement-oriented Behavior Style is the behavior directly related to encouraging excellence in performance by setting challenging goals, seeking improvement, showing excellence in performance and portraying confidence that subordinates will achieve quality performance. All the type of Leader's behavior

### Third Opinion

The discipline of opinion leadership study has its roots in the work of Lazarsfeld, who investigated the 1940 presidential election (Goldsmith and De Witt, 2003). Following this, Katz and Lazarsfeld (1955) dedicated an entire volume to personal influence in the consumption process, concluding that communication flows from the source to the opinion leaders, who pass it on to the others in the social system. In the corporate context, opinion leaders play an important role in advice networks and communities of practice (Cross et al. 2006). In e-commerce settings, opinion leaders are crucial in determining trends (Herring et al. 2005) and in influencing shopping behavior (Chan and Mirsa 1990). Joni (2004) then introduced the term third opinion leadership and indicates that many top leaders nowadays relying on external parties to get ideas for more effective and quality financial decision-making. For certain leaders, the power of thinking partners will also be the factor of success in making the decision (Hoffberg and Korver, 2006). Thus, third opinion is a thinking partner, a partner with whom someone can think more profoundly with (Business Network, 2010). Third opinion leaders can be classified as anyone who is a consultant or a family member to the decision maker. They act as an advisor or supporter to the decision maker (Business Network, 2010). In certain countries, external people or "third opinion leaders" influence the actions of legislators, get laws passed or change the rules for government agencies (Kahai and Sosik, 1997). Third opinion leaders on the other hand are also the filters of ideas and information. Joni (2004) believes that the third opinion leader will help the decision maker in making quality decision.

According to Joni (2004), there are three characteristics of third opinion leaders: (1) Third Opinion's Mind which is defined as people with knowledge and high thinking level (Ennis, 2001). Third opinion mind were described based upon three levels of thinking skills namely, (i) skills to identify the characteristics of a problem and know how to find solution, (ii) deep understanding and (iii) expertise in specific fields of knowledge such as finance, economics, technology or science, and expertise in one or more fields of knowledge; (2) Third Opinion's Relationship which refers to the networking or with whom leader have contact. Leaders developed relationship based on personal trust such as through family member, friends or

consultant; and (3) Third Opinion's Focus refers to someone with ideas, creativity and innovativeness. According to Canfield, Hansen, and Hewitt (2000), focus can be a powerful tool for helping an individual to achieve goals and decision quality but can also interfere with a person's efforts at goal attainment (Locke and Latham, 1990).

Many researcher has found that, third opinion intervention plays an important role between leaders behavior and decision making quality. According to Krantz and Kunreuther (2007), if someone seeks more information from other people or sources, they can make effective decision. It is supported by Joni (2004) that leaders today need someone who can support them to give good suggestion and opinion in making good decision. Katz and Lazarsfeld (1955) and Weimann, Tustin, Vuuren and Joubert (2007) argued that third opinion will give new idea and innovation to the leaders to make great decisions. Thus, it is proposed that third opinion is a contingent factor upon leaders behavior and decision making quality.

## Research Findings

### Leader's and Company's profile

Unit of analysis for this study is decision and purposive sampling was used to distribute the questionnaires to 500 respondents but only 225 questionnaires were returned. However, a total of 14 questionnaires which contained incomplete answers were not used. Thus, a total of 211 questionnaires were used and analyzed. The total response rate for this survey was 42.2%.

According to the sample, 57.8 percent of the respondents were males and the remaining 4.42 percent were females. 34.6 percent of the respondents were less than 30 years of age, 39.8 percent were between 30 to 39 years of age, 20.9 percent were between 40 to 49 years old, and 4.7 percent of the respondents were aged between 50 to 58. According to the sample of 211 respondents, 86.3 percent of the respondents were Malays, 9.5 percent were Chinese, and 4.3 percent represented the Indian race. With regards to education, the highest number (46.4 percent) of the respondents completed the first degree at bachelors level. 21.8 percent of the respondents completed their study at diploma level and 21.3 percent of the respondents hold Masters degree.

The job profile of decision makers showed that the majority of the respondents in this study (24.6 percent) worked in the banking sector. 19.4 percent is a business owners. The other respondents worked in the manufacturing sector (16.1 percent), service sector (14.7 percent) and the rest of the respondents worked in other sectors such as tourism and hospitality. In terms of who made the decisions, the majority of the ldecision-makers in this sample were the middle manager (40.3%) designated as heads of department or heads of programs followed by managers (38.9%) who were branch managers, team leaders and project leaders. 20.9 percent comprised upper manager level that is Chief Executive Officers (CEO), Chief Financial Officers (CFO), Directors and Business Owners.

It is argued that different decisions need different types of external references of individuals (third opinion). Therefore, it is crucial to scrutinize the decision profile as it might point towards different leaders behavior. The data shows that most of the decisions in the sample are related to asset acquisitions such as computers, land, etc. (34.29%), and 26.98% are related to financial investments (shares, bonds, etc). Another 22.86% are decisions related to loan and credit management, 8.89% are related to business expansion and the final 6.98% are the decisions related to mergers and acquisitions. Refer to Table 1

### Third Opinion's Profile

To measure the level of third opinion being used in making financial decision, Table 2 indicates that the majority of the respondents state that third opinions were moderately used in their financial decision making (37.9%); 31.8 percent frequently used third opinions in their making of financial decisions; and only 15.2 percent state that they were high frequent users in referring to third opinions for their financial decision making process. The rest of the respondents rate that they rarely rely on third opinions in making financial decisions (14.7%) and 0.5 percent never rely on third opinions in their decision making.

In terms of types of third opinions sought by the leaders/decision makers, 22.76 percent of the decision makers stated that they relied on media for third opinion information, 18.85 percent sought opinions from consultants, 18.16 percent from

friends, 16.09 percent from associations/clients, 14.48 percent from families and 9.66 percent from their business colleagues.

### **Descriptive Analysis**

Descriptive analysis in general indicate that the most opinion sought by the decision maker were those from individuals with knowledge and high thinking level. Thus, 'Third Opinion Mind' were among the highest influence to the decision maker with mean of 5.75 followed by 'Relationship' (mean=5.37) and 'Focus' (mean=5.16). Refer to table 3.

#### **Test of Differences**

In general, there are no significant differences between the 'third opinion' and the respondents' profiles. There are also no significant differences between third opinion needed and types of financial decisions made. However, for third opinion's mind and third opinion's focus, Post Hoc tests show differences only between organization and position of the decision makers. The significance different was also found between leadership behavior and third opinion.

Decisions made by managers who worked as Business Owners prefer to seek third opinion's mind (mean=5.9) and as compared to those who work in the government and banking sectors who seek more for third opinion focus. (mean=5.4). Upper and middle managers seem to have a similar degree of agreement based on referring to third opinion's mind (both have mean=5.8). Lower managers, however, have the lowest degree of referring to third opinion's mind but were found to have the highest degree of referring to third opinion's focus .

In general, it shows that directive leaders prefer to seek for people who have creative ideas and innovativeness (third opinion's focus). Supportive and participative leaders on the other hand prefer people whom they trust and have high networking and good relationships with them (third opinion's relationship). For achievement-oriented leaders, they prefer people with knowledge and high thinking level (third opinion's mind). Thus, results on test of differences can be summarized in Table 4.

### **Test of Relationship**

Hierarchical regression shows that third opinion's focus is quasi-moderator for leaders behavior and decision making quality. This indicates that those leaders (third opinion) who are full with ideas, creativity and innovativeness has direct and contingent effect to financial decision quality. Third opinion's mind and third opinion's relationship on the other hand act as pure moderator as they have no direct effect and only enhancing the relationship between leader's behavior and financial decision making quality.

Decision makers that possess achievement-oriented behavioral style relying on third opinion mind (i.e. individual with skills and experience) and third opinion relationship (i.e network and trust) to achieve their financial quality decision. Those with directive behavioral style on the other hand relying on third opinion mind. Participative behavioral style and directive behavioral style relying on third opinion relationship and third opinion focus (i.e, creativity and innovative) respectively. However, leaders with supportive behavior styles need no influence from top opinion leader. Thus, the findings reveal that certain leadership behavioral styles need different type of third opinion leadership as moderator.

#### **Conclusion and Recommendation for Future Research**

The findings of the study indicates that third opinion was moderately sought by the decision maker in their decision making process. Most of the third opinion leaders sought by the decision makers are third opinion mind which are those with skills and knowledge. The present study found that decision makers who are a business owners, upper level manager and possess achievement-oriented leadership style prefer to rely on third opinion mind, in their decision making process. Third opinion mind also enhance the relationship between the achievement oriented behavior with financial decision making quality.

However decision makers who work at the government and banking sectors; those from lower level position and decision makers with directive behavioural style sought most from the third opinion focus as they prefer someone who possess great ideas, creative and innovative. The results is consistence with Kerr and Tindale, (2004) and Weimann, Tustin, Vuuren and Joubert (2007) confer that third opinion may give new ideas and innovation to the leaders to make great decisions. Decision makers with suportive and participative syles would prefer to rely on those people who are close to them and people who they trust (third opinion relationship).

Waldman Ramfrez, House and Puranam (2001) studies have confirmed that leaders' style affects group-work process, social climate, organization performance, quality decision and results. Evkall and Ryhammar (1998) explained that the leadership style can influence the work environment in decision making, which eventually producing a product or service quality. This is because; leadership styles have a direct impact on productivity and performance of an organization. Different dimension of leadership style will impact a different result of decision making (Goleman, 2000).

For future research, it is suggested that the differences in relation to leadership styles should be studied more extensively to reach various conclusions of comparison. Moreover, it is important to recognize the nature and source of the effect of institutions on leadership style that would become the most important goals in research leadership in the era of globalization, which is full of business activities.

It is also suggested that research related to leadership styles in a different country can be used as a valuable channel for studying the influence of national culture or ethnicity in the manager's leadership style with different nations and peoples in terms of external people (third opinion). Future studies may want to consider, for example, the impact of management values and strategic orientation of the organization or firm's leadership style among managers. In addition, future research could also examine the relationship between leadership styles, third opinion and the firm's performance in Malaysia.

In addition, Miller (1994) also says that organizational culture encompasses the values and norms that support the extent to which managers can look for an outsider (third opinion) to help make effective decisions. In summary, to increase the internal validity of research results, a larger sample size and the use of random sampling should be used for future research. Cultural factors and intermediate effects of the leadership style are also items that need to be reviewed in the future.

## References

- Borgatti, S. P. (2006). Identifying Sets of Key Players in a Social Network.
- Brousseau, K., Driver, M., Hourihan, G., and Larsson, R. (2006), "The Seasoned Executive's Decision-Making Style", *Harvard Business Review*, Vol. 84 No.2, pp.111-21.
- Business Network, CBS News. Why Every Leaders Needs a Third Opinion. (June 1 2010). [www.bnet.com](http://www.bnet.com)
- Canfield, J., Hansen, M. V. and Hewitt, L. (2000). *The Power of Focus*. Deerfield Beach, FL: Health Communications.
- Carr, J. B. and Brower, R. S. (2000) 'Principled Opportunism: Evidence from the Organizational Middle', *Public Administrative Quarterly*, 24(1): 109-138.
- Chan, K. K., and Mirsa, S. (1990). Characteristics of the Opinion Leader: A New Dimension. *Journal of Advertising*, 19(3), 53-60.
- Chaney, I. M. (2001). Opinion Leaders as a Segment for Marketing Communications. *Marketing Intelligence and Planning*, 19(5), 302-308.
- Clegg, S. R., Hardy, C., and Nord, W. (1996) (Eds.) *Handbook of Organizational Studies*. Thousand Oaks, CA: Sage Publications, Inc.
- Cross, R., Laseter, T., Parker, A., and Velasquez, G., "Using Social Network Analysis to Improve Communities of Practice," *California Management Review*, Vol. 49, No. 1:32-60, 2006.
- Dubrin, A. J. (1995), *Leadership: Research Findings, Practice, and Skills*. Boston: Houghton Mifflin Company.

- Dulewicz, V., and Higgs, M. J. (2000). Emotional Intelligence: A Review and Evaluation Study. *Journal of Managerial Psychology*, 15(4), 341–368.
- Emden, Z., Calantone, R. J., and Droge, C. (2006). Collaborating for New Product Development: Selecting the Partner with Maximum Potential to Create Value. *The Journal of Product Innovation Management*, 23:330-341.
- Ennis, R. (2001) An Outline of Goals for A Critical Thinking Curriculum and Its Assessment in Costa, A. (Ed.) *Developing Minds: A Resource Book for Teaching Thinking*. Alexandria, VA: Association for Supervision and Curriculum Development.
- Evkall G, and Ryhammar L (1998) Leadership Style, Social Climate and Organizational Outcomes: A study of Swedish University College. *Creativity Innovative Management* 7: 126-182.
- Flynn, L. R., Goldsmith, R. E., and Eastman, J. K. (1996). Opinion Leaders and Opinion Seekers: Two New Measurement Scales. *Journal of the Academy of Marketing Science*, 24(2), 137- 147.
- Goldsmith, R. E., and De Witt, T. S. (2003). The Predictive Validity of an Opinion Leadership Scale. *Journal of Marketing Theory and Practice*, 11(1), 28-35.
- Goleman, D. (2000) Leadership That Gets Results. *Harvard Business Review* 78: 78-90.
- Handy, C. B. (1982). *Understanding Organizations*. London: Penguin.
- Herring, S. C., Kouper, I., Paolillo, J. C., Scheidt, L. A., Tyworth, M., and Welsch, P. (2005). Conversations in the blogosphere: An analysis "from the bottom-up". In *Proceedings of the 38th Hawaii International Conference on System Sciences (HICSS'05)*. Los Alamitos: IEEE Press.
- Hoffberg, K., and Korver, C. (2006). Great Leadership, Great Decisions, Great Outcomes. *Decision Quality Index* , 1-16.
- House, R. J. (1971). A Path-Goal Theory of Leader Effectiveness. *Administrative Science Quarterly*, September, 321-338.
- House, R. J. (1977) A 1976 Theory of Charismatic Leadership. In J. G. Hunt and L. L. Larson (Eds.) *Leadership: The cutting edge*. Carbondale; Southern Illinois University Press.
- House, R. J., and Mitchell, R. R. (1974). Path-goal theory of leadership. *Journal of Contemporary Business*, 3, 81-97.
- Joni, S.-n. A. (2004). *The Third Opinion: How Successful Leaders Use Outside Insight to Create Superior Results*. New York: Penguin Group (USA) Inc.
- Kahai S., and Sosik J. (1997) "Effects Of Leadership Style and Follower's Cultural Orientation on Performance in Group and Individual Task Conditions". *Personnel Psychology*. Vol. 50. N° 1, pp. 121-147.
- Katz, E., and Lazarsfeld, P. F. (1955). *Personal Influence*. New York: Free Press.
- Kaval, V., and Voyten, L. J., (2006). Executive Decision-making: Effective Processes for Making and Implementing Decisions. *Healthcare Executive*, 21(6), 16-22.
- Keren, G., and Bruin, W. B. (2003). On the Assessment of Decision Quality: Considerations Regarding Utility, Conflict and Accountability. In D. Hardman, and L. Macchi, *Thinking: Psychological Perspectives on Reasoning, Judgment and Decision Making*. (pp. 348-363). Pittsburgh: John Wiley and Sons, Ltd.
- Koopman, P. L., and Wierdsma, A. F. M. (1998). Participative Management. In P. J. D. Doentu, H. Thierry, and C. J. de-Wolf (Eds.), *Personnel psychology: Handbook of work and organizational psychology* (Vol. 3, pp. 297–324). Hove, U.K.: Psychology Press/Erlbaum.
- Kouzes, J., and Posner, B. (2007). *The Leadership Challenge*. New York, NY: Jossey Bass, a Division of John Wiley and Sons.
- Krantz, D. H., and Kunreuther, H. C. (2007). Goals And Plans in Decision Making. *Judgment and Decision Making*, 2(3), 137–168 (June).

- Locke, E. A., and Latham, G. P. (1990). *A Theory of Goal Setting and Task Performance*. Englewood Cliffs, NJ: Prentice Hall.
- McCaffery, P. (2004). *The Higher Education Manager's Handbook: Effective Leadership and Management in Universities and Colleges*. London and New York: RoutledgeFalmer.
- Moss, H.K., and Kinnear, T.L. (2007). Nothing Can Eliminate Responsibility. *Supervision*, 68(1), 3-4.
- Northouse, P. G. (2001). *Leadership: Theory and Practice (2nd Ed.)*. Thousand Oaks, CA: Sage.
- Oygard, L. "Divorce Support Groups: What Factors are of Importance Regarding Friendship Development in the Groups?" *Social Work with Groups*, Vol. 26, No. 4, 2003.
- Partington, D. A. (2003). *Managing and Leading*. In J. R. Turner (Ed.), *People in project management*. Aldershot, UK: Gower.
- Podsakoff, P. M., MacKenzie, S. B., Paine, B., and Bacharach, D. (2000). 'Organizational Citizenship Behavior: A Critical Review of the Theoretical and Empirical Literature and Suggestions for Future Research'. *Journal of Management*, vol. 26, no. 3, pp. 513-563.
- Rogers, E. M. and D. L. Kincaid (1981), *Communication Networks: Toward a New Paradigm for Research*, New York: The Free Press.
- Scheufele, D. A. (1999). *Participation as Individual Choice: Comparing Motivational and Informational Variables and Their Relevance for Participatory Behavior*. Unpublished doctoral dissertation, University of Wisconsin, Madison.
- Sharma, S., Durand, R.M., and Gur-Arie, O. (1981). Identification and Analysis of Moderator Variables. *Journal of Marketing Research*, 18, 291-300.
- Sharma, V. K. (2003). Period Responses to Zeitgeber Signals Stabilize Circadian Clocks during Entrainment. *Chronobiol. Int.* 20:389-404.
- Simon, H. A. (1987). Making Management Decisions: The Role of Intuition and Emotion. *Academy of Management Executive*, 1, 57-64.
- Waldman D, Ramirez G, House R, and Puranam P. (2001) Does Leadership Matter, CEO Leadership Attributes and Profitability Under Conditions of Perceived Environmental Uncertainty. *Acad. Manag. J.* 44: 134-143.
- Weimann, G., Tustin, D. H., Vuuren, D. v., and Joubert, J. P. (2007). Looking for Opinion Leaders: Traditional vs. Modern Measures in Traditional Societies. *openUP*, 1-18.
- Yukl, G. (2002). *Leadership in Organizations*. (5th ed.) Upper Saddle River, NJ: Prentice Hall.

## Tables and Figures

Table 1: Financial Decision Profile

	Frequency	Percentage (%)
Financial Investments (share, bond, etc)	85	26.98
Assets' Acquisition (computer, land, etc)	108	34.29
Business Expansion	28	8.89
Loan and Credit Management	72	22.86
Mergers and Acquisitions	22	6.98

Table 2: Third Opinion Profile

Decisions (N=211)		
	Frequency	Percentage (%)
<u>Reference to Third Opinions</u>		
Never	1	0.5
Rare	31	14.7
Moderate users	80	37.9
Frequent users	67	31.8
Highly frequent users	32	15.2
<u>Type of third opinions that leaders/decision makers sought</u>		
Friends		79 (18.16%)
Business colleagues		42 (9.66%)
Association / Clients		70 (16.09%)
Family		63 (14.48%)
Consultant		82 (18.85%)
Media (Newspaper, magazines, electronic, etc)		99 (22.76%)

Table 3: Descriptive statistics of Variables

Decision N = 211				
Variables	Min.	Max.	Mean	Std. Dev
<u>Third Opinion</u>				
Mind	4.00	7.00	5.75	.66743
Relationship	4.00	6.60	5.37	.62129
Focus	3.25	6.50	5.16	.61495

Table 4: Test of Difference

	Third Opinion					
	Mind		Relationship		Focus	
	F-value	P-value	F-value	P-value	F-value	P-value
<u>Respondents' Profiles:</u>						
Age	1.928	.126	.720	.541	1.433	.234
Education	1.713	.166	.552	.582	1.388	.248
<u>Job Profiles</u>						
Organization	2.428	.036*	.822	.535	2.990	.013*

Position	4.613	.011*	1.419	.244	4.321	.014*
Types of Financial Decisions	1.008	.404	1.515	.199	.708	.587
<b>Leaders ' Behavior</b>						
Directive	2.936	.000***	2.409	.003**	3.475	.000***
Supportive	1.374	.153	2.528	.001**	1.869	.023*
Participative	1.806	.030*	2.133	.007**	1.568	.076
Achievement-oriented	2.642	.001**	.853	.617	2.553	.002**

Significant level: \*\*\*&lt;0.000, \*\*&lt;0.01, \*&lt;0.05

Table 5: Hierarchical Analysis Result

MODEL VARIABLES	DEPENDENT VARIABLE					
	QUALITY OF FINANCIAL DECISIONS					
	Model 1		Model 2		Model 3	
	Std. beta	Sig.	Std. beta	Sig.	Std. beta	Sig.
<b>1. Independent variables:</b>						
Directive	.186	.013*	.055	.429	-1.738	.021*
Supportive	.215	.003**	.144	.033*	-.793	.230
Participative	.203	.006**	.209	.002**	1.307	.030*
Achievement-oriented	.201	.008**	.159	.026*	2.041	.028*
<b>2. Moderating variables:</b>						
Mind			.131	.034*	-.466	.474
Relationship			.125	.041*	-.096	.899
Focus			.266	.000***	1.301	.021*
<b>3. Interaction variables:</b>						
<i>1. Mind x Leadership Style</i>						
Mind_Directive					2.232	.020*
Mind_Supportive					.845	.365
Mind_Participative					1.677	.080
Mind_Achievement					-4.112	.000***
<i>2. Relationship x Leadership Style</i>						
Relationship_Directive					-1.494	.071
Relationship_Supportive					1.040	.354
Relationship_Participative					-2.015	.049*
Relationship_Achievement					2.715	.002**
<i>3. Focus x Leadership Style</i>						
Focus_Directive					2.175	.018*



Focus_Supportive			-.534	.570
Focus_Participative			-1.461	.093
Focus_Achievement			-1.764	.097
<hr/>				
F-value	27.688***	27.198***	13.822***	
R square	.350	.484	.579	
Adjusted R square	.337	.466	.537	
R square change	.350	.134	.095	
F change	27.688	17.688	3.590	

---

## Synchronization Possibilities and Features in Java

Beqir Hamidi

Lindita Hamidi

ILIRIA College Bregu i Diellit, st. Gazmend Zajmi, no. 75

p.n., 10 000 Prishtine-Kosove -Prishtine

beqirhamidi@hotmail.com,

hamidi.lindita@gmail.com

### Abstract

*In this paper we have discussed one of the greatest features of the general purpose computer programming language –Java. This paper represents concepts of Synchronization possibilities and features in Java. Today's operating systems support concept of "Multitasking". Multitasking achieved by executing more than one task at a same time. Tasks runs on threads. Multitasking runs more than one task at a same time. Multitasking which means doing many things at the same time is one of the most fundamental concepts in computer engineering and computer science because the processor execute given tasks in parallel so it makes me think that are executing simultaneously. Multitasking is related to other fundamental concepts like processes and threads. A process is a computer program that is executing in a processor, while a thread is a part of a process that has a way of execution: it is a thread of execution. Every process has at least one thread of execution. There are two types of multitasking: process – based and thread – based. Process-based multitasking, means that on a given computer there can be more than one program or process that is executing, while thread-based multitasking, which is also known as multithreading, means that within a process, there can be more than one thread of execution, each of them doing a job and so accomplishing the job of their process. When there are many processes or many threads within processes, they may have to cooperate with each other or concurrently try to get access to some shared computer resources like: processor, memory and input/output devices. They may have to, for example: print a file in a printer or write and/or read to the same file. We need a way of setting an order, where processes and/or threads could do their jobs (user jobs) without any problem, we need to synchronize them. Java has built-in support for process and thread synchronization, there are some constructs that we can use when we need to do synchronization. This paper, a first phase discussed the concept of Parall Programming, threads, how to create a thread, using a thread, working with more than one thread. Second phase is about synchronization, what is in general and in the end we disscused the synchronization possibilities and feautres in Java.*

Keywords: Thread, Process, Multithreading, Synchronization, Java language.

### 1 Introduction

Many applications from scientific computing can benefit from object-oriented programming techniques, since they allow a flexible and modular program development. Often, these applications are computation-intensive, so the sequential execution time is quite large. Therefore it is profitable to use a parallel machine for the execution. But up to now, no parallel object-oriented programming language has been established as a standard.

Java is a popular language and has support for a parallel execution integrated into the language. Hence, it is interesting to investigate the usefulness of Java for executing scientific programs in parallel.

In the following sections we have covered in more detail the problem starting threads, how to create a thread, using a thread, working with more than one thread, synchronization , what is in general and in the end we disscused the synchronization possibilities and feautres in Java.

### 2 Processes and Threads

"In concurrent programming, there are two basic units of execution: *processes* and *threads*. In the Java programming language, concurrent programming is mostly concerned with threads". However, processes are also important.

A computer system normally has many active processes and threads. This is true even in systems that only have a single execution core, and thus only have one thread actually executing at any given moment. "Processing time for a single core is shared among processes and threads through an OS feature called time slicing. It's becoming more and more common for computer systems to have multiple processors or processors with multiple execution cores. This greatly enhances a system's capacity for concurrent execution of processes and threads — but concurrency is possible even on simple systems, without multiple processors or execution cores".

Thread and Process are two closely related term in multi-threading and main difference between Thread and Process in Java is that *Threads are part of process*, while one process can spawn multiple Threads.

To understand multithreading, the concepts *process* and *thread* must be understood. A *process* is a program in execution. A process may be divided into a number of independent units known as *threads*. A *thread* is a dispatchable unit of work. Threads are *light-weight* processes within a process. A process is a collection of one or more threads and associated system resources. The difference between a process and a thread is shown in Figure 1. A process may have a number of threads in it. A thread may be assumed as a subset of a process [1].

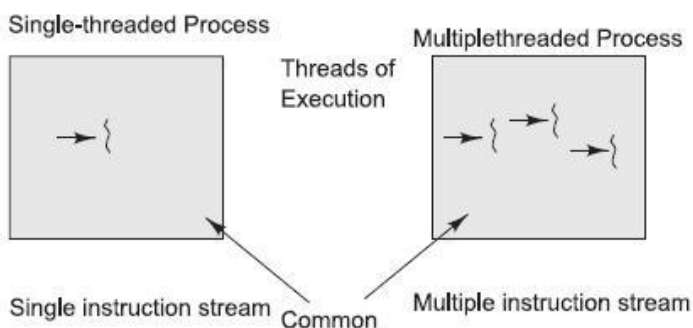


Figure 16 A process containing single and multiple threads.

Multitasking of two or more processes is known as *process-based multitasking*. Multitasking of two or more threads is known as *thread-based multitasking*. The concept of multithreading in a programming language refers to thread-based multitasking. Process-based multitasking is totally controlled by the operating system. But thread-based multitasking can be controlled by the programmer to some extent in a program

**Thread creation:** In contrast to most other programming languages where the operating system and a specific thread library like Pthreads [2] or C-Threads are responsible for the thread management, Java has a direct support for multithreading integrated in the language, see, e.g., [3]. The `java.lang` package contains a thread API consisting of the class `Thread` and the interface `Runnable`. There are two basic methods to create threads in Java.

Threads can be generated by specifying a new class which inherits from `Thread` and by overriding the `run()` method in the new class with the code that should be executed by the new thread. A new thread is then created by generating an object of the new class and calling its `start()` method.

An alternative way to generate threads is by using the interface `Runnable` which contains only the abstract method `run()`. The `Thread` class actually implements the `Runnable` interface and, thus, a class inheriting from `Thread` also implements the `Runnable` interface. The creation of a thread without inheriting from the `Thread` class consists of two steps: At first, a new class is specified which implements the `Runnable` interface and overrides the `run()` method with the code that should be executed by the thread. After that, an object of the new class is generated and is passed as an argument to the constructor method of the `Thread` class. The new thread is then started by calling the `start()` method of the `Thread` object. A thread is terminated if the last statement of the `run()` method has been executed. An alternative way is to call the `interrupt()` method of the corresponding `Thread` object.

**Multithreading in Java:** “A thread is an independent context of execution within a process. A process can have more than one thread. All threads of a process share the resources allocated to the process. An operating system that supports this behavior is a multi-threaded operating system and a programming language that gives constructs/API to create and manage threads is called a multi-threaded programming language “ [4]. Java has in built support to the multi-threading. Java is a *multithreaded programming language* which means we can develop multithreaded program using Java. A multithreaded program contains two or more parts that can run concurrently and each part can handle different task at the same time making optimal use of the available resources specially when your computer has multiple CPUs. Multitasking is when multiple processes share common processing.

**Thread synchronization:** The threads of one program have a common address space. Thus, access to the same data structures have to be protected by a synchronization mechanism. Java supports synchronization by implicitly assigning a lock to each object. The easiest way to keep a method thread-safe is to declare it synchronized. A thread must obtain the lock of an object before it can execute any of its synchronized methods. If a thread has locked an object, no other thread can execute any other synchronized method of this object at the same time. An alternative synchronization mechanism is provided by the wait() and notify() methods of the Object class which also supports a list of waiting threads. Since every object in the Java system inherits directly or indirectly from the Object class, it is also an Object and hence supports this mechanism. When a thread calls the wait() method of an object, it is added to the list of waiting threads for that object and stops running. When another thread calls the notify() method of the same object, one of the waiting threads is woken up and is allowed to continue running. These basic synchronization primitives can be used to realize more complex synchronization mechanisms like barriers, condition variables, semaphores, event synchronization, and monitors, see, e.g., [3].

### 3 Synchronization processes

Using many threads to running tasks has some advantages and disadvantages. We need to take a control when more than one thread share a same resource or same piece of data. Controlling access of threads in same resource done by technique called “Synchronization”.

To use synchronization, specific data structures should be included in a system, and they should be manipulated by a set of functions.

To provide this functionality the Java has summarize synchronization variables in each and every object. The manipulating of these synchronized variables is done by the help of a thread.join(), synchronized keyword and other methods. These are included in all the libraries and they provide the coordinating of the instructions of threads. Shared data can be protected by means of synchronization variables.

**Atomic Actions:** Atomic operation means an operation that completes in its entirety without interruption [5].

One common source of bugs in concurrent programs is the failure to implement atomic actions correctly. An atomic action acts on the state of a program. The program's state contains a value for each variable defined in the program and other implicit variables, such as the program counter. An atomic action transforms the state of the program, and the state transformation is indivisible[6].

An action is atomic if the processes performing it:

- Are not aware of the existence of any other active process, and no other active process is aware of the activity of the processes during the time the processes are performing the action.
- Don't communicate with other processes while the action is being performed.

- Can detect no state change except those performed by themselves and it they don't reveal their state changes until the action is complete.
- Can be considered, so far as other processes are concerned, to be indivisible and instantaneous, such that the effects on the system are as if they were interleaved as opposed to concurrent.

First, an interface can be defined for a three-way atomic action, which is represented in Listing 3.

```
public interface ThreeWayAtomicAction
{
    public void role1();
    public void role2();
    public void role3();
}
```

Listing 1 A fragment code of three way atomic action.

In following is represented structure for three way atomic action which is show in Figure 2.

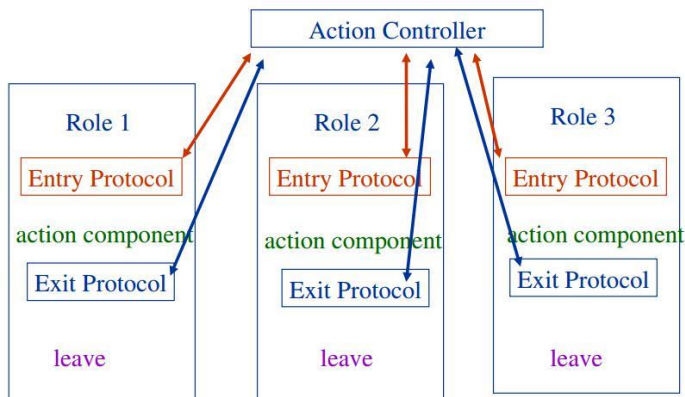


Figure 17 Structure of three role of action controller

The code listed below is based on the structure of which is shown in Figure 4, which declaration a declaration a public class AtomicActionControl.

```
public class AtomicActionControl implements
ThreeWayAtomicAction
{
    protected Controller Control;
    public AtomicActionControl() // constructor
    {
        Control = new Controller();
    }
    class Controller
    {
        protected Boolean firstHere, secondHere, thirdHere;
        protected int allDone;
        protected int toExit;
        protected int
        numberOfParticipants;
        Controller()
        {
            firstHere = false;
            secondHere = false;
            thirdHere = false;
            allDone = 0;
            numberOfParticipants = 3;
            toExit = numberOfParticipants;
        }
        synchronized void first() throws InterruptedException
        {
            while(firstHere) wait();
            thirstHere = true;
        }
        synchronized void second() throws InterruptedException
        {
            while(secondHere) wait();
            secondHere = true;
        }
        synchronized void third() throws InterruptedException
        {
            while(thirdHere) wait();
            thirdHere = true;
        }
    }
}
```

Listing 2 Declaration a public class for AtomicActionControl.

Fragment code in Listing 3 is the continuation of Listing 2, which synchronizes three action.

```
synchronized void first() throws InterruptedException
{
    while (firstHere)
        wait();
    firstHere = true;
}
synchronized void second() throws InterruptedException
{
    while(secondHere)
        wait();
    secondHere = true;
}
synchronized void third() throws InterruptedException
{
    while (thirdHere) = true;
    wait();
    thirdHere = true;
}
synchronized void finished() throws InterruptedException
{
    allDone++;

    if(allDone == numberOfParticipants)
    {
        notifyAll();
    }

    else while(allDone != numberOfParticipants)
    {
        wait();
    }
    to exit --;
    if (toExit == 0)
    {
        firstHere = false;
        secondHere = false;
        thirdHere = false;
        allDone = 0;
        toExit = numberOfParticipants;
        notifyAll ();
    }

    // release processes waiting for the next action
}
}
```

Listing 3 A fragment of code that could be synchronized three actions.

Following fragment code in Listing 4 is the continuation of Listing 3, which declaration Entry Protocol and Exit Protocol in Role1.

```

public void role1()
{
    boolean done = false;
    while (!done)
    {
        try                ← Entry Protocol
        {
            control.first();
            done = true;
        }

        catch (InterruptedException e) { // ignore
    }
    // .... perform action

    done = false;
    while(!done)
    {
        try                ← Exit Protocol
        {
            Control.finished();
        }

        catch (InterruptedException e) { // ignore }
    }
}
};

```

Listing 4 Entry Protocol and Exit Protocol in Role1.

**Critical Sections:** “As an introduction to concurrent programming, a fundamental problem called the *critical section problem*” [7]. The problem is easy to understand and its solutions are small in terms of the number of statements they contain (usually, fewer than five). However, the critical section problem is not easy to solve, and it illustrates just how difficult it can be to write even small concurrent programs.

“A code segment that accesses shared variables and that has to be executed as an atomic action is referred to as a *critical section* [6]. The critical section problem involves a number of threads that are each executing the following code in Listing 5”:



```
while (true)
{
    entry-section

    critical section // accesses shared variables
or other shareresources.

    exit-section

    noncritical section // a thread may terminate its execution in this
section.

}
```

Listing 5 A fragment of code that describe critical problem.

Listing 6 A fragment of code that could be synchronized three action.

The entry- and exit-sections that surround a critical section must satisfy the following correctness requirements [8SPG91]:

- **Mutual exclusion.** When a thread is executing in its critical section, no other threads can be executing in their critical sections
- **Progress.** If no thread is executing in its critical section and there are threads that wish to enter their critical sections, only the threads that are executing in their entry- or exit-sections can participate in the decision about which thread will enter its critical section next, and this decision cannot be postponed indefinitely.
- **Bounded waiting.** After a thread makes a request to enter its critical section, there is a bound on the number of times that other threads are allowed to enter their critical sections before this thread's request is granted.

#### 4 Synchronization in Java

To use synchronization, specific data structures should be included in a system, and they should be manipulated by a set of functions.

To provide this functionality the Java has summarize synchronization variables in each and every object. The manipulating of there synchronized variables is done by the help of a `thread.join()`, synchronized keyword and other methods. These are included in all the libraries and they provide the coordinating of the instructions of threads. Shared data can be protected by means of synchronization variables.

Semaphores, condition variables, wait sets, `join()`, barriers etc are used to prevent threads from useless waste. Using the synchronized (this) block is so common in instance methods that Java provides a shortened notation for specifying that an instance method is synchronized against its invoking object. These are functionally equivalent definitions of instance method foo is represented in Listing 6 :

```
synchronized void foo()  
{  
    void foo()  
}  
count +=2;
```

Listing 7 A fragment of code that describe Method foo.

**Semaphores:** “Semaphores are an abstract data type which is used to restrict the usage of common shared resources in concurrent programming. Semaphores are implemented mainly in restricting the number of threads that can access some resource”[9].

Semaphores are used for managing the threads that are waiting for something. This can performed by having a thread call `sem_wait()` in semaphore which have value zero, than the value of semaphore can increment by another thread <sup>1</sup>. This is shown in Listing 8.

```
Java (from Semaphore.java)  
s.semWait();  
s.semPost();
```

Listing 8 A fragment of code that initializing a semaphore.

In the Listing 9, we declare a semaphore `s` and initialize it to the value 1 by passing 1 in as the third argument. The second argument to `sem_init()` will be set to 0 in all of the examples we'll see; this indicates that the semaphore is shared between threads in the same process. See the man page for details on other usages of semaphores (namely, how they can be used to synchronize access across different processes), which require a different value for that second argument. After a semaphore is initialized, we can call one of two functions to interact with it, `sem_wait()` or `sem_post()`. The behavior of these two functions is seen in Listing 9. For now, we are not concerned with the implementation of these routines, which clearly requires some care; with multiple threads calling into `sem_wait()` and `sem_post()`, there is the obvious need for managing these critical sections. We will now focus on how to use these primitives; later we may discuss how they are built. We should discuss a few salient aspects of the interfaces here. First, we can see that `sem_wait()` will either return right away (because the value of the semaphore was one or higher when we called `sem_wait()`), or it will cause the caller to suspend execution waiting for a subsequent post. Of course, multiple calling threads may call into `sem_wait()`, and thus all be queued waiting to be woken. Second, we can see that `sem_post()` does not wait for some particular condition to hold like `sem_wait()`. Rather, it simply increments the value of the semaphore and then, if there is a thread waiting to be woken, wakes one of them up. Third, the value of the semaphore, when negative, is equal to the number of waiting threads [10].

**Monitors:** The most basic method of communication between threads in Java is synchronization, which is implemented using monitors. A unique monitor is assigned to each object in Java and any thread dealing with the objects reference can lock and unlock the monitor. A locked monitor ensures exclusive access and any other threads trying to lock the same monitor are blocked until the monitor is unlocked.

A monitor is a class used the content of concurrency. The instances of the class will thus be object simultaneously used by several processes. The all methods of the monitor are running with mutual exclusion. Thus, at the same time the methods of the monitor could be running from only one thread. The orders of the mutual exclusion do so easy usage the methods

---

that include a monitor. The other property of the monitor makes the threads to wait for a condition, during this time, when threads are waiting, the thread provisionally take up its exclusive access and should re take it after completed the condition. After completion of the condition one or some threads can be signaled.

## Conclusions

At the end of this paper, we have concluded that when it comes to process and thread synchronization, Java offers many possibilities. Its built in constructs for synchronization are not difficult to understand and use in many synchronization scenarios (although we have covered them in general), from those that require allowing just one thread of execution to use protected shared resources at a time to those that may allow a number of threads use protected shared collections of a computer resource.

## References

- S. Oaks and H. Wong. *Java Threads*. O'Reilly & Associates, Inc., 1999, Multithreaded Programming.
- D. R. Butenhof. *Programming with POSIX Threads*. Addison-Wesley Longman, Inc., 1997.
- S. Oaks and H. Wong. *Java Threads*. O'Reilly & Associates, Inc., 1999.
- Krishna Mohan Koyya. A quick at Java Threads. In *Threads and Multi-Threaded System*, pages 11-12, Glarimy Technology Services, 2011.
- Abraham Silberschatz, Peter B. Galvin and Greg Gagne, *Operating System Concepts* 8<sup>th</sup> edition, pages 234, July 29,2008
- Richard H. Carver and Kuo-Chung Tai, *Modern Multithreading, Implementing, testing and debugging Multithreaded Java and C++/Pthreads/Win32 Programs*, Published by John Wiley & Sons, Inc., Hoboken, 2006.
- Dijkstra and Edsger W, Solution of a problem in concurrent programming control, *Communications of the ACM*, Vol. 8, No. 9 (September), page 569.
- Silberschatz A, J. L. Peterson and P.Galvin. *Operating System Concepts Reading*, pages 121, 1991

---

## Comparison of the Three Welfare States in terms of Health Clinic Standarts

**Visar Ismaili**

PhD. Cand University Trnava/ Slovakia

### Abstract

*In the beginning I would like to explain a few words about my thesis. This work helps me comparing and analyzing the systems properly and to present as a result a very good system. Shortly, I hereby present the health system in Germany. This promotion with the matter, to compare the health systems helps me an adequate system for Kosovo shape. I have a questionnaire designed by the client to consult at the clinics. This presentation is a work of my self-formulated questions, so I want to minimize the deficits of Kosovo's health care system. Through the questionnaire, we come closer to an objective perspective of the poor Kosovar health system. This time I have 100 surveys at two hospitals, University Hospital Regensburg in Germany, where I live for the moment and Regional Hospital in Gjilan, Kosovo (my birth place).*

Keywords: Comparison,,Welfare States, Germany, Kosovo, health system, clinic

### Introduction

Before I start with the results, I would like to explain some information about the German health care system.

This work helps Kosovo society to remove many negative aspects of the health care system. We know where the weak points are; we start with a few organizational issues, to quality and quantity.

### German health system

Health insurance was, as already mentioned in the introduction of social insurance, introduced in 1883. It is an important milestone in the social network, as it offers protection to people who are sick and need medical services.

The legal basis is the health insurance in the Fifth Book of the Social Code (SGB V).

But the emphasis lies today, according to a brochure BEK, the active health promotion -preventive and responsibility. In this regard, many health insurance companies offer for members contemporary for sale, such as Courses on healthy eating, exercise training and back training.

### Health insurance types

About 90% of German citizens are insured with the statutory scheme. A relative small minority has taken out private health insurance or is covered in another way.

To distinguish between the types of health insurance and I quote an article published on the Internet, the RCDS Social Info 6:

The statutory health insurance premium amount depends on the income. The principle of statutory health insurance is solidarity between the healthy and the sick and the solidarity of those receiving high incomes with those lower incomes. The supply in case of illness identical and always ensures all the means necessary for recovery. A feature of the statutory health insurance is the principle of co-insurance, which is particularly relevant for families. If the employed parent statutory health insurance, both the spouse and the children are insured. Even the unemployed are members of this community of solidarity; it pays for the labor office, the insurance premium.

Similar to the statutory health insurance work the spare cash. Take many of the same tasks as the Local Health Insurance (AOK), statutory health insurance. The services provided differ little from each other.

The decision whether or AOK insurance fund is essentially a matter of taste. Who knows what he is, for example, after studying will work as an engineer, is certainly not bad advice, if he chooses the same for a sector-specific replacement checkout. These facilities offer which interest him preventive and white typically assess work-related diseases. "

---

Furthermore, it should also be noted that students are basically family insurance until the age of 25 years old, without their own contributions. Have you done military service / community service, then the family insurance extended even to this period? Only then they change in the student health insurance.

In addition to the statutory health insurance, there is private health insurance. To define this I quote again the published article in the RCDS Social info 6, Page 2 of 4:

Private health insurance, calculate their contributions based on the actual disease risk, which is based on earnings. Academics are i.d.R. sooner or later good customers of private health insurance. The market is highly competitive. To promote the private sector with low student rates barely above the statutory rate in order to provide students with early binding. The scope of services is often considerably better: Frequently eliminated copayments, doctors may higher rates and additional services and settle abroad are also covered.

The disadvantages seem small in comparison: The insured then must face the doctor often occur in intermediate consumption, which requires a financial cushion. The return to a statutory health insurance is very difficult without change of status, which may have a negative impact because of the income-related calculation with falling revenues.

Now according to distinguish the types of insurance we come to the services:

### **Health insurance benefits**

The health insurance benefits are very extensive, ranging from medical treatment to tooth replacement. Now, a brief overview of the major benefits, published in a brochure,, social security in Germany "BEK 4, page 12:

- Medical treatment
- Drugs and dressings
- Travel expenses
- Early detection of disease
- Health promotion and disease prevention
- Home Care
- Domestic help
- Remedies (such as massage)
- Aids (such as hearing aids)
- Orthodontic Treatment
- Sick pay
- Hospital care
- Cures
- Pregnancy and maternity benefits
- Prevention of dental disease
- Dental treatments
- Dentures and crowns

### **Posts**

The contributions to the statutory health insurance will be approximately 15, 5%. It is supported equally by the employer and half by the employee.

The contributions of the private health insurance are different and are determined by the profession and the risk class associated with it. So it happened that a worker with a higher risk of disease more than pays a self with a low morbidity and risk of accidents.

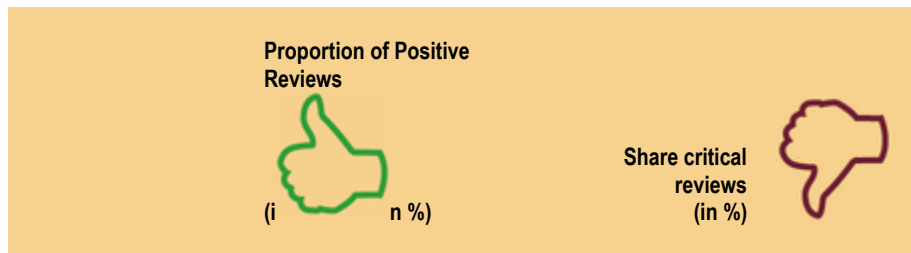
It was a short Expose as far as the health insurer in Germany, through the health system of Kosovo; I have unfortunately not much can end finish. Kosovo-driven health insurance type is similar to the Anglo-Saxon.

Because I live in Germany, I have a lot Researches, I wanted to test the performance of the hospitals, in order to determine, where lie the problems or difficulties.

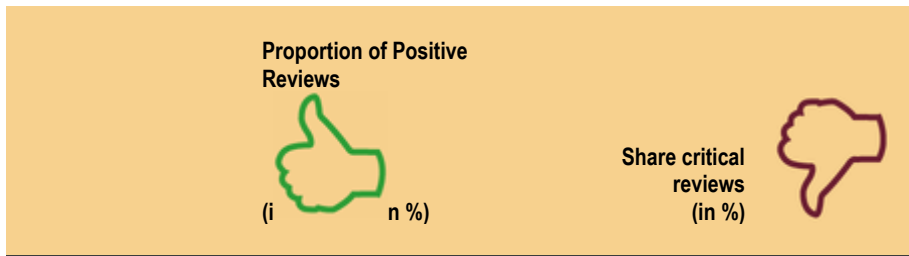
That's why I reconstructed a table with several questions; the questions were answered by the patients themselves. Below we see next, the results from the clinic in Berlin. That was a long project, which lasted a year.









I present the results of a study from Germany.

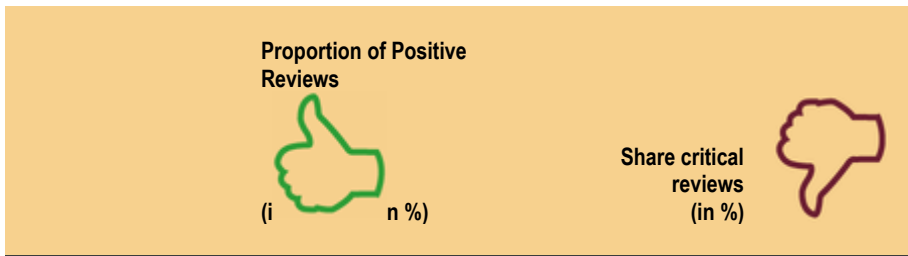
The quality of service is in addition to the quality of medical results part of patient benefit and thus for HELIOS of great strategic importance. The results presented here are the result of a single and continuous survey with a standardized questionnaire, which has been offered for a long time in Germany, especially in acute care hospitals.







<b>Overall assessment</b> ?	<b>96,8 %</b>	0102030405060708090100	<b>3,2 %</b>
<b>Further Recommendation</b> ?	<b>97,5 %</b>	0102030405060708090100	<b>2,5 %</b>
<b>Reception</b> ?	<b>91,7 %</b>	0102030405060708090100	<b>8,3 %</b>



<b>Overall assessment</b> 	<b>96,8 %</b>	0102030405060708090100	<b>3,2 %</b>
<b>Further Recommendation</b> 	<b>97,5 %</b>	0102030405060708090100	<b>2,5 %</b>
Doctors 	<b>94,8 %</b>	0102030405060708090100	<b>5,2 %</b>
Nurses 	<b>94,7 %</b>	0102030405060708090100	<b>5,3 %</b>
Waiting times 	<b>80,6 %</b>	0102030405060708090100	<b>19,4 %</b>
Cleanliness 	<b>88,1 %</b>	0102030405060708090100	<b>11,9 %</b>
Food 	<b>83,3 %</b>	0102030405060708090100	<b>16,7 %</b>
Release 	<b>89,7 %</b>	0102030405060708090100	<b>10,3 %</b>



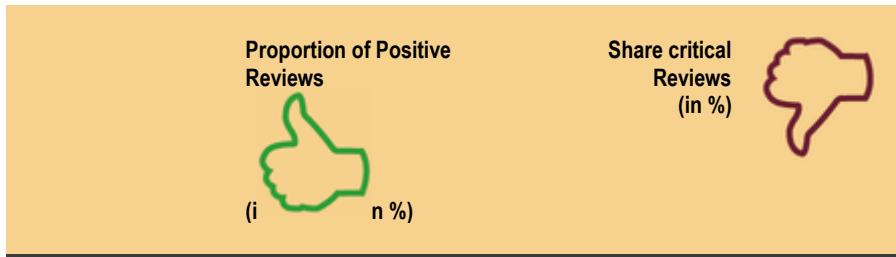
<b>Overall assessment</b> 	<b>96,8 %</b>	0102030405060708090100	<b>3,2 %</b>
<b>Further Recommendation</b> 	<b>97,5 %</b>	0102030405060708090100	<b>2,5 %</b>
Cooperation 	<b>95,5 %</b>	0102030405060708090100	<b>4,5 %</b>
Reconciliation 	<b>87,5 %</b>		<b>12,5 %</b>

There is a large discrepancy between the two populations, so the Germans so may result in a standard of living have gone through a long journey. This trip end this challenge to Kosovo expected. Here will present the results of Gnjilane Hospital.

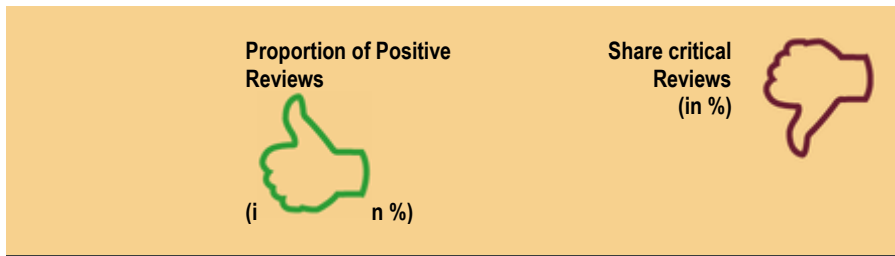
It was a product of chance, there were about 211 questionnaires, the results I got with the help of the SPPS. The results did not find a very large margin. We can assess themselves and lead a Debate here.

**Hospital of Gnjilane:**  
 100 Experiments





<b>Overall assessment</b> <sup>?</sup>	16 %	59 M 41 F	84 %
<b>Further Recommendation</b> <sup>?</sup>	18 %		82 %
<b>Reception</b> <sup>?</sup>	12 %		88 %
<b>Doctors</b> <sup>?</sup>	27 %		73 %
<b>Nurses</b> <sup>?</sup>	53 %		47 %
<b>Waiting times</b> <sup>?</sup>	21 %		79 %
<b>Cleanliness</b> <sup>?</sup>	9 %		91 %



Overall assessment <sup>?</sup>	16 %	59 M 41 F	84 %
Further Recommendation <sup>?</sup>	18 %		82 %
Food <sup>?</sup>	22 %		78 %
Release <sup>?</sup>	15 %		85,3 %
Cooperation <sup>?</sup>	84 %		16 %
Reconciliation <sup>?</sup>	87 %		13 %

## Conclusions

My idea and suggestion would be to lead a discussion with the participants, so that we can draw this conclusion with each other, why is the health system so poorly coordinated, which factors suggest an improvement of benefit packages in the clinics. In addition, policies in place, namely the Ministry of Health should help and stimulate, through finance clinics and hospitals here, so that patients have as much supply and quality to be recovered in the country, not to go and find other countries for health care.

## Literature:

1. *Harry Heine*, Shaker, Aachen 2007, 114 p., ISBN 978-3-8322-6062-0 (5) *Nachkriegsgeschichte/n. Sozialwissenschaftliche Beiträge zur Zeit(geschichte)*, Shaker, Aachen 2007, 266 p., ISBN 978-3-8322-6507-9 (6) <http://www.wiesenhausbblatt.de>
2. *Frank Pilz*, Das Politische System Deutschlands, Oldenbourg Wissenschaftsverlag Taschenbuch, 1995
3. Einführung in das politische System der Bundesrepublik Deutschland, Oldenbourg Wissenschaftsverlag, 1985.
4. Michael Knapp, Statistik SPSS, Universität Regensburg, 2003

---

## Motivating Reading Comprehension

**Assoc. Prof. Dr. Petraq Vasil Buka**

English Department, Faculty of Foreign Languages, University of Tirana

[petraqbuka@hotmail.com](mailto:petraqbuka@hotmail.com)

### Abstract

Reading is an interactive process going on between the reader and the text, leading to comprehension. The text presents letters, words, sentences and paragraphs and the reader uses knowledge, skills and strategies to determine what that meaning is. To comprehend such texts readers have to use comprehension activities such as reading the text several times, asking questions to get missing information, summarizing, making a choice between a literal and a figurative interpretation of the information. Comprehension is the goal of reading, but it can be the most difficult skill to master, especially for English language learners. Good readers tend to use a range of strategies while reading such as making predictions before reading, making connections to personal experiences and knowledge, etc. reading comprehension is much more than decoding. Reading comprehension is a result of the reader's knowledge of which skills and strategies are appropriate and how to apply them and accomplish the reading purpose. Comprehension instruction promotes the ability to learn from text. It gives students access to important domains of knowledge and provides a means of pursuing effective goals. When teaching a language, instruction in reading strategies is an integral part of the use of reading activities. Students should be taught how to use strategies before, during and after reading in order to help them become effective readers.

**Keywords:** comprehension, strategy, ability, decode, educator, strategies

### Introduction

The students' ability to read and understand information presented in written form is referred to as reading comprehension. It is also referred to as the ability of an individual to understand information in a text. Reading is not a passive activity. Being not able to read effectively, sometimes people cannot understand the main information in a text as they lack sufficient knowledge of the subject matter. The use of comprehension strategies helps readers expand their knowledge background and makes them capable of comprehension and learning.

Good readers ask questions about the characters, main idea or plot, clarify the confusing parts, and connect text events to their own prior knowledge and experiences. The knowledge that readers have and use when necessary helps them read texts on a subject they are acquainted with faster than readers who do not have that background. Teachers must teach students the comprehension skills to help them understand the text.

Reading comprehension consists of two elements: listening comprehension and word decoding. People may have a different ability to comprehend or decode words. Decoding is one of the basic skills that support reading, and struggling readers often have decoding difficulties. Decoding words is necessary, but it is not sufficient for reading comprehension and one needs to develop language comprehension skills. At the same time, children with good decoding skills and weak listening comprehension are struggling with language difficulties that are an obstacle to reading comprehension. Thus, reading comprehension is much more than decoding. Reading comprehension is a result of the reader's knowledge of which skills and strategies are appropriate and how to apply them and accomplish the reading purpose.

### Background knowledge

Background knowledge plays an important role in reading comprehension. Readers with good background knowledge will have no difficulty when using comprehension strategies. Readers with missing background knowledge are involved in the same comprehension process as they build up their knowledge. They need to use their background knowledge when reading difficult texts.

Reading is an interactive process going on between the reader and the text, leading to comprehension. The text presents letters, words, sentences and paragraphs and the reader uses knowledge, skills and strategies to determine what that meaning is. To comprehend such texts readers have to use comprehension activities such as reading the text several times, asking questions to get missing information, summarizing, making a choice between a literal and a figurative interpretation of the information.

Comprehension is the goal of reading, but it can be the most difficult skill to master, especially for English language learners. Good readers tend to use a range of strategies while reading such as making predictions before reading, making connections to personal experiences and knowledge, etc. Teachers can teach and promote the use of these effective comprehension strategies to help their students become even more proficient readers. The purpose for reading and the type of text, in turn, determine the knowledge, skills and strategies to be applied by readers in order to achieve comprehension. The appropriate approach to reading comprehension is also determined by the purpose for reading.

Students should use reading strategies in order to maximize their comprehension of text, identify relevant as well as non-relevant information, and avoid word-by-word comprehension. Teachers should raise students' awareness of reading as a skill requiring active engagement and teaching reading strategies. They will help students develop the ability to handle communication situations outside the classroom. In order to accomplish this goal, teachers should concentrate on the process of reading and not on its product.

Motivation for reading is an important factor to students' reading achievement and success at school. Motivation for reading is different from motivation for other subjects, such as science, social studies, or mathematics. Although reading motivation contributes directly to reading comprehension, reading motivation is related to students' reading proficiency.

The communicative approach to language teaching, however, provides different understanding of the role of reading as well as the types of text that can be used. The only way to develop communicative skills is by reading everyday materials. As a result, instruction in reading and reading practices are essential parts of language teaching at every level.

The existence of a text comprehension problem is sometimes identified in association with other problems, such as written text decoding, communication abilities, and spoken language. It is obvious that students who find it difficult to understand what they read will no doubt have difficulties in studying new information, and in many other situations requiring text comprehension.

When teaching a language, instruction in reading strategies is an integral part of the use of reading activities. Students should be taught how to use strategies before, during and after reading in order to help them become effective readers. Teachers should ask students to think and talk of how they read in their native language in order to develop their awareness of the reading process and reading strategies.

### **Comprehension difficulties**

Comprehension difficulties are often an aspect of learning disabilities or of cognitive difficulties. Teachers deal with children who have difficulty understanding what they have read. However, this problem is not always a specific reading comprehension difficulty. It is often related to written text comprehension, for example, language disorders or a text decoding problem. Written text comprehension is one of the abilities most evaluated all over the world. Problems with decoding, dyslexia, and language disorders have attracted more interest from researchers than have specific comprehension problems.

Teachers should show students strategies that help them in reading and explain to them how and why they should use the strategies. In addition to practicing reading strategies in class, students should also be asked to practice them outside of class in their reading assignments. Teachers should encourage students to be conscious of what they are doing while completing reading assignments.

Many individuals have difficulty acquiring literacy skills due to an inappropriate and insufficient amount of instruction. It is important that assessment is used to target specific areas of need so that appropriate types and amounts of instruction are implemented. Individual differences in reading comprehension may reflect differences in working memory capacity. A poor reader's memory capacity may be inefficient, so they acquire a smaller amount of additional information that can be

maintained in working memory. Although the ultimate goal of reading instruction is to help children acquire the skills necessary to comprehend text, an important goal for early reading instruction is to teach children to identify words on the printed page.

To help students develop communicative competence in reading, teachers must choose reading activities that resemble real-life reading tasks. The reading material should be authentic and the kind of material that students need and want to be able to read when studying, or using the language in other contexts outside the classroom. The reading purpose must also be authentic in order that students could read for reasons that make sense and have relevance to them. The reading approach must be authentic and students should read a text in a way that matches the reading purpose, the type of text and the way people normally read.

### Using strategies

Comprehension strategies are plans or steps that good readers use to make sense of text. Comprehension strategy instruction helps students become active readers in control of their own reading comprehension. Students who are good at monitoring their comprehension know when they understand what they read and when they do not. They have strategies to "fix" problems in their understanding as the problems arise. Instruction can help students become better at monitoring their comprehension.

An important aspect of learning to read is understanding how to use strategies to aid comprehension. Skimming, using context to discern unfamiliar words, and taking notes to aid remembering can promote reading comprehension and learning. Learning to read strategically is related to children's cognitive development as well as to the social contexts of instruction.

Despite good intellectual abilities, some students cannot find their way in the written texts they read. They do not seem to grasp the most important elements or the connections between the different parts. Sometimes these difficulties are not immediately detected by the teacher in the early school years. This is because the most obvious indicators of reading progress do not involve comprehension of written texts, or maybe because the first texts are quite simple and only reflect the difficulty level of the oral messages with which the child is already familiar. However, as texts get more and more complex, comprehension difficulties will become increasingly apparent and detrimental to effective school learning.

When learners comprehend, they interpret, analyse, and evaluate ideas in texts. When comprehending, learners strive to process text beyond word-level. When comprehension is successful, learners have a sense of satisfaction for having understood the meaning of a text. Comprehension takes the learner to a new level of active understanding and insight. It enhances language and vocabulary knowledge. Good learners use a variety of comprehension strategies and, they know how to apply specific strategies to aid their comprehension.

There are many reasons for considering reading comprehension one of the main goals of learning and education. Good reading comprehension remains the most important key for school learning. Teachers frequently rate the learning ability of their pupils, coming to the conclusion that many of them experience problems. However, the relationship between a specific reading comprehension problem and school failure is not necessarily reciprocal. Children with a reading comprehension problem will probably fail in school, but pupils who fail in school do not necessarily have a reading comprehension problem.

One of the problems facing secondary school teachers today is that many students lack the required knowledge, and skills to read and comprehend the materials placed before them. Good instruction is the most powerful means of developing proficient students and preventing reading comprehension problems. Comprehension instruction promotes the ability to learn from text. It gives students access to important domains of knowledge and provides a means of pursuing effective goals. The major challenges in the area of reading education consist in understanding how children learn to comprehend the material they are reading, how to deliver instruction that promotes comprehension, how to assess comprehension, and how to prevent poor comprehension outcomes.

The challenge is to identify classroom practices or activities that will evoke situational interest related to reading. The teachers use of stimulating tasks is considered as the best way to maintain student motivation. Providing stimulating tasks is among the most highly rated practices that increased motivation for unmotivated students. "Stimulating tasks" refer to tasks that stimulate students to think in new ways. Motivational activities related to reading comprehension are needed

---

more often for unmotivated students than for motivated students. The motivation of low-achieving students increase when books are connected to activities in which these students participate.

### **Achieving proficiency**

Proficient readers use their minds actively to build meaning. They read purposefully and selectively. Proficient readers use strategies to achieve their goals, no matter if they are reading for pleasure, to acquire new knowledge, or to perform a task. They connect what they already know with what they are reading. When proficient readers get confused, they realize this right away and apply appropriate strategies. They might identify the source of the confusion, and then explain it to themselves. They might make connections to fill in what the author leaves unsaid. And they might record important ideas and information, or ask themselves questions. The strategies are used regularly by proficient readers. Teachers should demonstrate and explain why particular strategies are useful as well as how and when to use them.

Students do not receive the optimal instruction. Teachers' lack of knowledge about how to teach effectively may be especially weak for working with students who are unable to learn with traditional methods. Sometimes teachers are frustrated because students act inappropriately during class, perform inadequately in homework and class assignments, and do poorly in class tests. Teachers rarely reflect on their own insufficient preparation or lack of teaching skills, blaming poor student performance on low motivation and lack of interest in school.

Children's reading skills and performance are associated with willingness to engage in reading. Facilitating and fostering motivation provides yet another approach for aiding and improving children's reading comprehension skills. Reading comprehension could be facilitated by including motivational elements into instruction, materials, activities and programs.

Although most young children seem to acquire proficiency in early reading skills, older students struggle with texts in middle school. Why do children who seem to be proficient readers in the early grades struggle to comprehend texts in later grades? One answer lies in the role of reading instruction within the curriculum. Schools should put into place the systematic assessment practices necessary to identify the sources of difficulty for both young and adolescent readers and the support necessary to allow teachers to address them. To prevent young readers from falling behind in middle, schools must strengthen reading instruction. Taking action is important because many of the struggling students make up a significant part of the classrooms.

### **Assessment of knowledge**

Assessment is an ongoing process helping students understand their strengths in order to become successful readers. Each student's progress is monitored by making regular observations during instruction. Teachers can explain key strategies and monitor actions before, during, and after reading. Students need ongoing feedback to facilitate their proficiency at using comprehension strategies. Providing instruction in the key elements of a strategy helps students at all grade levels.

Effective comprehension strategies can be accomplished through cooperative learning, which involves students working together in small groups on clearly defined tasks. Cooperative learning instruction has been used successfully to teach comprehension strategies. Students work together to understand texts, helping each other learn and apply comprehension strategies. Teachers help students learn to work in groups.

Learners who struggle with comprehension possess inefficient strategies. They need to be shown how and when to apply comprehension strategies. Providing students with instruction in comprehension strategies can be an effective way to help them overcome difficulties in understanding texts. The more explicit the comprehension strategy, the higher the likelihood that the learner will make significant gains in comprehension. As learners become more competent and confident of their comprehension, the less support they require from the teacher

Struggling readers must overcome many challenges in order to succeed in school. One obvious challenge is the disparity between their reading ability and the required reading materials. A few learners gain a level of independent reading and learning competence. Without effective assistance from teachers, struggling students may never gain these proficiency and self-confidence. Struggling readers are least likely to spend time on reading outside of school. Furthermore, students from

---

lower socio-economic status have the least amount of language interaction at home. The consequence is that these students have little opportunity for development and practice of comprehension abilities, highlighting the need to provide the most effective school instructional practices.

### Conclusions

The importance of reading well has never been in dispute. Reading well provides practical tools for communication, for work, and for learning itself. Yet, many students leave school without knowing how to read well. Knowing effective practices may suffice to bring successful learning to many students. But helping readers who are struggling to achieve requires deep understandings of the kinds of instructional practices that affect students' comprehension.

The issue of what makes strategy instruction effective is reflected in comments made by a number of scholars, related to the issue of what is essential for comprehension instruction. The positive effects result from more time spent reading and thinking about text rather than from specific learning about strategies. Strategies instruction might not be needed if student attention could simply be focused on understanding text content. Some reading scholars even doubt whether it may be more effective to teach students to approach reading with a problem-solving perspective rather than to teach comprehension strategies. The notion of approaching comprehension instruction aims to direct students' attention toward the content of what they are reading connecting and integrating information as they proceed through the text.

### Bibliography

- Judith Orasanu. Reading Comprehension: From Research to Practice, 1986
- Joan Baker Gonzales/Eileen K.Blau /Building on Basics: a Thematic Approach to Reading Comprehension/Longman/1998
- John T. Guthrie - [Engagement and motivation in reading/Article/2000](#)
- L. Knoll /The Relationship Between Motivation and Reading Comprehension Christopher /Grand Valley State University/2000
- Emily A. Swan/Concept-Oriented Reading Instruction/2002
- Mastropieri, Margo A.Thomas E., Janet E./Reading Comprehensive Instruction for Secondary Students: Challenges for Struggling Students and Teachers/2003
- Allan Wigfield/Motivating reading comprehension: Concept-oriented reading instruction./University of Maryland /2004
- Kristi L Santi/Deborah K. Reed/[Improving Reading Comprehension of Middle and High School Students/ Literacy Studies, Vol. 10./2015](#)